

Macintosh® Repair & Upgrade Secrets

Larry Pina

HAYDEN BOOKS

A Division of Macmillan Computer Publishing
11711 North College, Carmel, Indiana 46032 USA

© 1990 by Larry Pina

FIRST EDITION
SECOND PRINTING—1990

All rights reserved. No part of this book shall be reproduced, stored in a retrieval system, or transmitted by any means, electronic, mechanical, photocopying, recording, or otherwise, without written permission from the publisher. No patent liability is assumed with respect to the use of the information contained herein. While every precaution has been taken in the preparation of this book, the publisher and author assume no responsibility for errors or omissions. Neither is any liability assumed for damages resulting from the use of the information contained herein.

International Standard Book Number: 0-672-48452-8
Library of Congress Catalog Card Number: 89-63715

Acquisitions/Development Editor: *James Rounds*
Manuscript Editor: *Joe Kraynak*
Cover Artist: *Ned Shaw*
Indexer: *Sherry Massey*
Technical Illustrator: *Tom Emrick*
Technical Reviewers: *Robert Bauer and John Stephenson*
Compositor: *Hartman Publishing*

Printed in the United States of America

Trademarks

All terms mentioned in this book that are known to be trademarks or service marks are listed below. In addition, terms suspected of being trademarks or service marks have been appropriately capitalized. SAMS cannot attest to the accuracy of this information. Use of a term in this book should not be regarded as affecting the validity of any trademark of service mark.

Apple is a registered trademark of Apple Computer, Inc.
Craftsman is a registered trademark of Sears, Roebuck & Company
Dupont is a registered trademark of Dupont Company
Finder is a trademark of Apple Computer, Inc.
Lisa is a registered trademark of Apple Computer, Inc.
Mac is a registered trademark of Apple Computer, Inc.
Macintosh is a registered trademark of Apple Computer, Inc.
MacWorks is a registered trademark of Apple Computer, Inc.
Microsoft is a registered trademark of Microsoft Corporation
Radio Shack is a registered trademark of Tandy Corporation
Teflon is a registered trademark of Dupont Company

Overview

Chapter 1	Safety Rules—Tools and Techniques	1
Chapter 2	Preliminary Checks	19
Chapter 3	Adjustments	41
Chapter 4	Power Supply Problems	55
Chapter 5	Video Problems	81
Chapter 6	Dead Sets	109
Chapter 7	Power Supply Upgrades—Fans	125
Chapter 8	Audio Upgrades	145
Chapter 9	Video Upgrades	159
Chapter 10	Disk Drive, RAM, ROM, and SCSI Upgrades	175
Chapter 11	Keyboard Repairs	207
Chapter 12	Mouse Repairs	223
Chapter 13	Lisa/Macintosh XL Repair Secrets	235
Chapter 14	Macintosh SE Repair Secrets	281

Table of Contents

	Preface	xv
	Acknowledgements	xvii
Chapter 1	Safety Rules—Tools and Techniques	1
	Standard Safety Precautions	1
	Hand Tools	2
	Take-Apart Procedure	6
	Test Equipment	13
	Soldering Equipment	15
	Diagnostics Software	15
	System Software—Setting Up Workdisks	16
	Choosing a Work Area—Setting Up the Bench	17
	Summary	18
Chapter 2	Preliminary Checks	19
	Objectives	19
	First Step—Which Macintosh?	20
	Starting Test Pattern Generator	22
	Choosing a Screen Size	24
	How the T-Squares Work	26

Checking the Height and Width	26
Metric System	27
Checking Linearity	28
Centering Test	29
Checking Circularity	30
Checking Screen Balance	32
Checking the Focus	33
Reversing the Video—Checking for Screen Ghosts	34
Advanced Techniques	36
Aspect Ratio	36
Setting Preferences	37
Checking the Voltage	38
Summary	40
Chapter 3	Adjustments
	41
<hr/>	
Inside Macintosh	41
Definitions	42
Tune-up Procedure	44
Adjusting the +5-V Supply	45
Adjusting the Cut-off	47
Adjusting the Width	49
Adjusting the Height	50
Synchronizing the Settings	51
Centering the Display	51
Adjusting the Focus	53
Balance Test	54
Chapter 4	Power Supply Problems
	55
<hr/>	
Which Analog Board?	56
Dealing with the Vinyl Jacket	59
1. Shut Down—Disconnect the Power Cord	59
2. Pry off the Vinyl Jacket—Clean up the Board	60
3. Clean the Jacket—Prepare it for Reinstallation	61
4. Scrub up—Clean up the Work Area	62
Low Voltage	63
Locating CR18 and CR19	63
Theory and Practice	64
Component Level Test Set-up	64
General Desoldering Procedure—Replacing the Diode	65
Checking Your Work	69

Fluctuating Voltage	69
1. Removing the Old Harness	70
2. Cleaning the Board Connectors	71
3. Treating the Board Connectors	71
4. Testing a Replacement Harness	71
Focus Control Problems	72
1. Burned Resistors—No Focus	73
2. Loose or Corroded Contacts on the CRT Socket Cable	75
3. Tarnish on the CRT Pins	76
Brightness Control Problems	78
Summary	80
Chapter 5	Video Problems
	81
Display Collapses to a Vertical Line	83
Cracked Solder Joints	84
C1 Failure	87
Jitters, Ringing, Ozone Smell, Worms in the Display	93
Identifying the Flyback Transformer	93
Identifying a Bad Flyback Transformer	95
Replacing the Flyback Transformer	98
Severe Distortion—Wavy Lines, Display Getting Darker	99
Testing Q3 (INTERNATIONAL Q2) Out-of-Circuit	100
Replacing Q3 (INTERNATIONAL Q2)	101
Set Makes a Burning Smell/Smokes	102
No Raster, Completely Dark	103
Display Collapses to a Horizontal Line	105
Display Collapses to a Pinprick	107
Summary	107
Chapter 6	Dead Sets
	109
Visual Inspection	111
Use a Magnifying Glass	112
Go with the Obvious	113
Check Resistor Values	114
Heat Wave Tip	115
Learn the Color Code	115
Tolerance	116
Flipping—Logic Board OK	117
Flipping Set—Analog Board OK	121
Summary	123

Chapter 7 Power Supply Upgrades—Fans 125

The Failure Avoidance Strategy	125
Minimum Analog Board Upgrade	126
Rationale for the Changes	126
Maximum Heavy-Duty Analog Board Upgrade	128
Rationale Behind the Capacitor Upgrades	129
Rationale Behind the Rectifier Upgrades	130
Other Considerations	131
Analog Board—Removal and Installation	131
Removal Instructions	131
Installation Instructions	133
Fan Upgrades	135
Piezoelectric Fans	135
DC Boxer Fans	139
AC Boxer Fans	142
Summary	144

Chapter 8 Audio Upgrades 145

Audio Repairs	145
No Sound	147
Scratchy Sound	150
Distorted Sound	150
Weak Sound	150
Audio Upgrades	150
The Technical Definition of Sound	151
Test Tone Oscillator	151
Adding a Speaker Grill	155
Adding an External Speaker	156

Chapter 9 Video Upgrades 159

Display Enlargements	159
Maintaining Linearity	160
Advantages	160
Other Considerations	160
Antiglare Magnification Screens	161
Installation	161
Advantages	161
Other Considerations	162

CRT Upgrades	163
Glare Test	163
CRT—Removal and Installation	164
Building a TTL Video Adapter	168
Construction Notes	169
Troubleshooting	171
External Monitor Adjustment	172
Other Considerations	173
Summary	173

Chapter 10	Disk Drive, RAM, ROM, and SCSI Upgrades	175
-------------------	--	------------

128K to 512K Logic Board Upgrades	175
Board Level 128K to 512K RAM Upgrades	176
Component Level 128K to 512K RAM Upgrades	177
Upgrading Model 820-0086-C Logic Boards	178
Upgrading Model 820-0141-A Logic Boards	184
Troubleshooting Component Level 128K to 512K Upgrades	185
Official 800K Disk Drive/ROM Upgrades	186
Disk Drive Removal	186
Replacing ROM Chips	187
Identifying ROM Versions	190
Unofficial 800K Disk Drive/ROM Upgrades	191
Exceptions for Older Drives	192
Mixing 800K and 400K Drives	193
Mac Disk Drive Upgrades for PC Compatible Computers	195
Unofficial SCSI Upgrades	196
Plug-in SCSI Upgrades	196
Clip-on SCSI Upgrades	197
Choosing a SCSI Upgrade	198
SCSI Upgrade Installation Problems	198
Board Level 512Ke to Mac Plus Upgrades	200
Cabling Requirements	201
Mac Plus SIMM Upgrades	202
SIMM Upgrade Concepts	202
1Mb to 2Mb SIMM Upgrades	203
1Mb or 2Mb to 2.5Mb SIMM Upgrades	204
1Mb, 2Mb, or 2.5Mb to 4Mb SIMM Upgrades	204
Troubleshooting SIMM Upgrades	204
Macintosh SIMMs vs PC SIMMs	205
Unofficial 512Ke to 4Mb Upgrades	205
Clip-on Memory Upgrades	205
Snap-on Memory Upgrades	206
Solder-on Memory Upgrades	206
Other Memory Upgrade Considerations	206

Chapter 11	Keyboard Repairs	207
	Standard Safety Precautions	207
	Disassembly Procedure	208
	Intermittent Key Switches	209
	Broken Key Switches	210
	Emergency Repairs	217
	Dead Keyboards	217
	Static Electricity	219
	Custom Keyboard Cables	219
	Summary	222
Chapter 12	Mouse Repairs	223
	Standard Safety Precautions	224
	How the Mouse Works	224
	Disassembly Procedure	225
	Erratic Mouse Pointer—Mouse Cleaning	227
	Reassembly Procedure	228
	Intermittent Mouse Button—Switch Replacement	229
	Testing the Mouse Switch	230
	Intermittent Mouse Functions	231
	Dead Mouse	232
	Testing the Mouse Cable for Continuity	233
	Rough, Unstable Tracking—Worn Mouse Feet	233
	Summary	234
Chapter 13	Lisa/Macintosh XL Repair Secrets	235
	Identifying the Models	235
	Lisa/XL Disassembly Procedure	237
	Automatic Startup Tests	247
	ROM Checksum	247
	MMU Register Test	249
	Memory Sizing	249
	Preliminary Memory Test	250
	VIA Test	250
	I/O Board Tests	251
	ROM Identification	252
	Booting the Operating System	253
	Built-in Service Mode	254
	Summary of the Diagnostics Routines	255

Mechanical Problems with the 3.5-Inch Disk Drive	256
Drive Makes Eject Noises but Disks Fail to Eject	256
Drive Does Not Make Eject Noises and Disks Get Stuck	260
Grinding Noises	261
Hard Drive Repairs	262
Startup Error 81	262
Startup Error 84	264
Sad Mac Error Code 0F0064	265
MacWorks Plus	266
What It Does	266
Miscellaneous MacWorks Plus Information	268
800K Disk Drive Upgrade	268
Internal Hard Drive Upgrades	270
Noisy Hard Drives	271
Expansion Card Upgrades	272
Memory Upgrades	273
Video Upgrades—External Monitors	274
Video Upgrades—Internal Monitor Macintosh XL Screen Kit	274
Summary	280

Chapter 14 **Macintosh SE Repair Secrets** **281**

Tools and Techniques—SE Specific Supplement to Chapter 1	281
Preliminary Checks—SE Specific Supplement to Chapter 2	284
Adjustments—SE Specific Supplement to Chapter 3	285
SE Tune-up Procedure	286
Power Supply Problems—SE Specific Supplement to Chapter 4	287
Dealing with the Vinyl Jacket	288
Wiring Harnesses	288
Focus Control Problems	288
Brightness Control Problems	288
Video Problems—SE Specific Supplement to Chapter 5	288
Dead Sets—SE Specific Supplement to Chapter 6	293
Power Supply Upgrades—SE Specific Supplement to Chapter 7	293
SE Analog Board—Removal and Installation	293
Audio Upgrades—SE Specific Supplement to Chapter 8	296
Video Upgrades—SE Specific Supplement to Chapter 9	297
Logic Boards—SE Specific Supplement to Chapter 10	297
SE Memory Upgrades	298
SIMM Upgrades for the Original SE Logic Board	299
SIMM Upgrades for the DIP SIMM SE Logic Board	300
Troubleshooting SIMM Upgrades	302
Keyboard—SE Specific Supplement to Chapter 11	302

	Mouse—SE Specific Supplement to Chapter 12	303
	Servicing the Desktop Bus	304
	Expansion Card Upgrades	305
	Internal Hard Drive Upgrades	307
	External Drive Housing Kits	307
	Internal Hard Drive Mounting Kits	308
	Setting the SCSI ID	309
	SCSI Terminators	310
Appendix A	Glossary	313
Appendix B	Dealer/Manufacturer Addresses	323
Appendix C	Parts List—Macintosh Analog Board—U.S. Version	327
Appendix D	Parts List—Macintosh Analog Board—International Version	335
Appendix E	Parts List—Macintosh SE Analog Board	341
Appendix F	Parts List—Macintosh SE CRT Socket Board	345

Preface

Every month, at various user group meetings, I listen to people with Macintosh hardware failures. Their story is always the same. They've been told that the Macintosh can't be repaired. New circuit boards cost hundreds of dollars! Some people are on their third or fourth boards. Well, the fact of the matter is that the Macintosh *can* be repaired—very easily. This book shows you how.

Beginning with the Macintosh power supply, I show you how to make repairs at the component level. No special technical skills are required, only the ability to read and follow directions. Even if you've never held a soldering gun before, this information could save you hundreds of dollars.

But the manufacturer doesn't sell replacement parts—so there's no way Macintosh computers can be repaired!

Unlike the proprietary ROM chips on the logic board, there's nothing special about the resistors, filter caps, and rectifiers on the power-supply board. Some parts are readily available from Radio Shack. Others have to be mail ordered. Replacement parts are no problem, as long as you know which parts to ask for and where to send for them. Throughout this book, that's exactly what you'll learn.

The symptoms listed in these chapters are real. The fixes are real. The methods presented here were perfected long ago. They work for me; they work for others; they're going to work equally well for you.

After you've mastered the repair and upgrade secrets revealed here, look for my next book—*Macintosh Printer Secrets* (ISBN: 0-672-18463-3).

To order, write to:

Attn: Ordering Department
Macmillan Publishing
Front and Brown Streets
Riverside, NJ 08075

Acknowledgments

Last fall, noted author and consultant Bob LeVitus, the former Editor-in-Chief of *MACazine*, introduced me to Literary Agent Bill Gladstone, President of Waterside Productions, Del Mar, California. Bill presented the book to Jim Rounds, Senior Development Editor of SAMS. If it weren't for Bob, Bill, and Jim, this book would still be a collection of notes, scattered about my workshop. Allow me to extend my heartfelt gratitude. *Macintosh Repair & Upgrade Secrets* simply wouldn't exist if it hadn't been for your help.

I'd also like to offer special thanks to John Hart and Ed DeSouza, of the Electrical Engineering Department at Southeastern Massachusetts University. Both men took special pains, on their own time, to track down sources, make suggestions, and share technical ideas. Like true educators, they were totally unselfish with their support.

Knowledgeable Mike Levesque of Grundy's Lumber Co. here in Westport, Massachusetts, spent a lot of time tracking down hard-to-find T-15 screwdriver sets. Thanks to Mike, we now know that you can get all the take-apart tools you need at the local True Value Hardware Store. If only all store personnel were as helpful as the guys down at Grundy's!

Irving Freeman, Chairman of the Science and Computer Department at Worcester Academy, contributed to the Lisa Chapter. In fact, it's Irving's hands that are shown working on the Widget hard drive in Figures 13-25 and 13-26. I took the pictures.

Thanks also goes to Ralph Jannini of Rajan Technology. Ralph is credited as the original source for the Widget fix that I learned from Irving.

Bob Cook and Roger Smith from Sun Remarketing, and Sam Neulinger from Dafax Processing were always there with overnight service whenever I needed something. Both companies actively support discontinued Apple Computers. They do a better job than most franchised dealers. On behalf of everyone with a discontinued Macintosh, all I can say is, "thank you for your support."

I'd also like to thank Bob Bauer, owner of Soft Solutions. Bob's company is *the* alternative source for Macintosh service, complete boards, and repair parts. Many of the top-secret repair tips offered in this book originally came to me by way of Bob. His technicians are top-notch. His Mac SE schematics appear with permission in Chapter 14.

Thanks also to Amar Singh and Vivian Schottlander of Sophisticated Circuits, and to Mike Frost of Technology Works. Some of their material is reproduced with permission in Chapters 10 and 14. It's excellent, and it speaks for itself.

Andrew Eisner, knowledgeable engineer and Labs Director, at *MacUser* Magazine gets special thanks for lending his support to Test Pattern Generator. Many features that are in the program today were Andrew's ideas. Many of the bugs that are not there are gone because Andrew pointed them out. Thanks also goes to the entire *MacUser* crew. You guys are the best.

CHAPTER



Safety Rules—Tools and Techniques

This chapter outlines the standard 128K to Macintosh Plus take-apart procedure. It's not intended to be a step-by-step tutorial—just an introductory discussion of safety rules, tools, and techniques. Even if you have a Macintosh SE or a Macintosh XL, please read this chapter for general information. Then, after you've gathered everything you need, read it again before undertaking repairs.

Standard Safety Precautions

Working on "live" electrical equipment requires extraordinary presence of mind. Other dangers are more obvious. High heat can be felt. Moving belts can be seen. Rotating machinery can be heard. We all know (without thinking) that mechanical effects which stimulate the senses are dangerous. Instinctively, we hold back. Electrical effects are different. They don't stimulate the senses. A charged circuit looks no different than a discharged circuit. We can't see the charge, hear it, or otherwise detect it. Our instinctive mechanisms fail. Because the Macintosh contains high-voltage electricity (just like a television set), the following standard safety precautions must be taken at all times:

1. Never take unnecessary chances. Whenever possible, unplug the computer's power cord. Disconnect all peripheral cables. Never work on live circuits unless you absolutely have to.

2. Never wear watches, rings, or necklaces when working around electrical equipment. Remove all personal jewelry. If a ring or a watch were to come in contact with live or charged electrical components, it could cause serious personal injury or even a fatal electrical shock! Always work jewelry free.
3. For the same reason, tie back long hair before working on electrical equipment. Never work with wet hair. Make absolutely sure long hair cannot fall into a charged electrical circuit.
4. Stay away from the picture tube and exposed electrical connections. Be especially mindful of any connections around the flyback transformer and the power switch. These areas contain dangerous high voltage.
5. Always wear eye protection when working around the picture tube.
6. Never allow children or pets in the work area. Regardless of how experienced you are, always work with a competent, adult assistant. Use the "buddy" system.
7. Know your limits. If unsure of any procedure, stop! For your own safety, seek further information or defer to qualified personnel.

To put point seven in perspective, consider the relationship between doctors, nurses, and EMTs (Emergency Medical Technicians). All three are capable of performing lifesaving medical procedures, but only doctors are qualified to operate. The same is true for computer repairs. Most readers will be able to perform at least some repairs, some readers will be able to perform all repairs, but not all readers will be able to perform every repair. Know your limits and stay safely within them.

Hand Tools

For safety, always start any Macintosh take-apart procedure by disconnecting the AC power cord. "Disconnect" means to physically separate it from the computer. Simply turning off the power switch is not enough. Next, check the lower, left side of the case for the presence of a programmer's switch. Programmer's switches are optional equipment, so you may not find one. After disconnecting the power cord, pry off the programmer's switch (assuming there's one installed) with a small, flat-head screwdriver as shown in Figure 1-1. Both the power cord and the programmer's switch must be removed before proceeding. Failing to remove the power cord is unnecessarily dangerous. Failing to remove the programmer's switch makes it very difficult to remove the rear cover.

Now lay the Macintosh on a soft towel. All 9-inch Macs are held together by T-15 screws and special friction tape. The 128K to Mac Plus has

five screws—two near the I/O (input/output) connectors, two inside the handle, and one inside the battery compartment. The Mac SE has four screws—two inside the handle and two near I/O connectors.

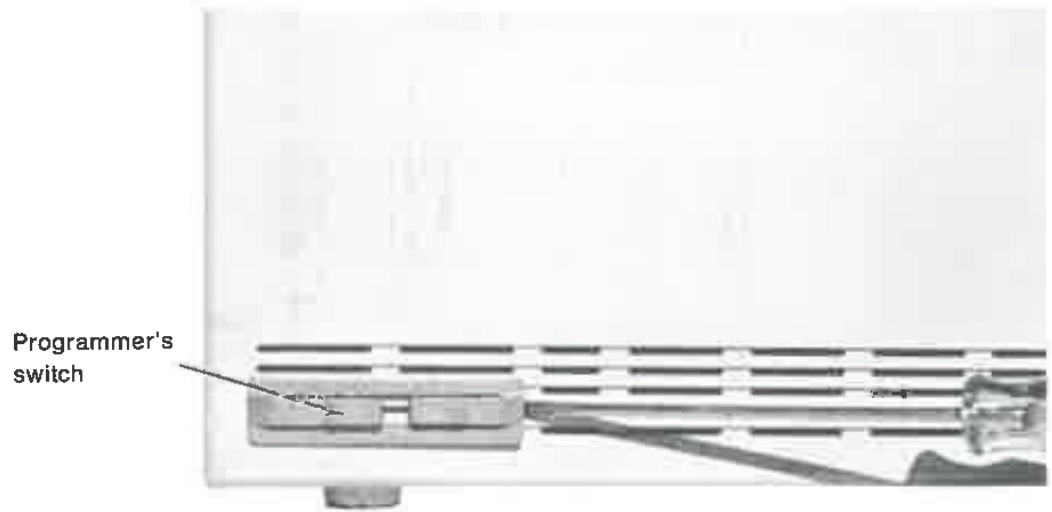

Figure 1-1 Pry off the programmer's switch (assuming there's one installed) with a small, flat-head screwdriver.

As shown in Figure 1-2, it takes an 8-inch long T-15 screwdriver and a small spring clamp to pry the case apart. Since 8-inch long, T-15 screwdrivers are hard to find, any of the following tools may be used instead:

1. A long reach T-handle hex key with a $\frac{7}{64}$ -inch tip and a 9-inch arm. This tool works in most cases, but not in all cases. If the screw heads are the least bit chewed, you may need another tool to get them out.
2. A precision ground flat-head screwdriver with an $\frac{1}{8}$ -inch wide blade and an 8-inch long shaft. Precision is the key word here. Some $\frac{1}{8}$ -inch screwdrivers actually have $\frac{3}{32}$ -inch blades. A $\frac{3}{32}$ -inch blade tends to strip T-15 screws. Other $\frac{1}{8}$ -inch screwdrivers actually have $\frac{5}{32}$ -inch blades. A $\frac{5}{32}$ -inch blade doesn't even fit T-15 screws! In general, never rely on the manufacturer's $\frac{1}{8}$ -inch label. Always check tool sizes for yourself.
3. A $\frac{1}{4}$ -inch drive mechanic's ratchet with a 6-inch long extension, a $\frac{1}{4}$ -inch socket, a $\frac{3}{8}$ -inch OD (outside diameter) bit holder, and a T-15 insert bit. The $\frac{3}{8}$ -inch outside diameter of the bit holder is critical. Typical $\frac{7}{16}$ -inch bit holders are too big to work in a Macintosh.

Examples of acceptable substitute tools are shown in Figures 1-3 to 1-5.

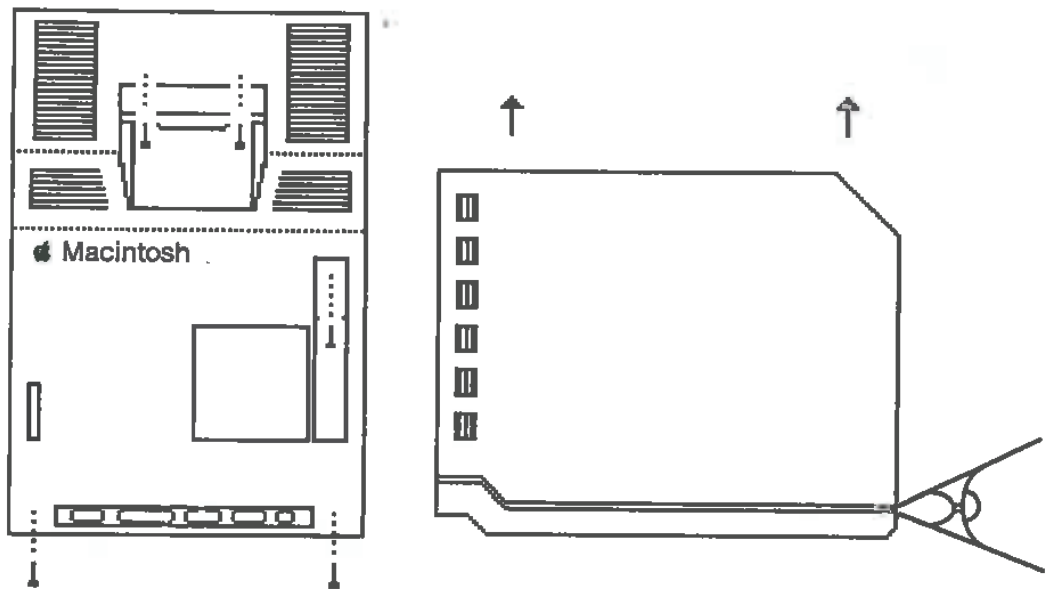

Figure 1-2 All 9-inch Macs are held together by T-15 screws and special friction tape. It takes an 8-inch long T-15 screwdriver and a small spring clamp to pry the case apart.

Before removing any screws, set aside a safe place to store them. Containers to avoid include hinged plastic boxes (they tend to fall backwards, spilling the contents) and small paper cups (they're easily knocked over). Most technicians use something with a screw lid and low center of gravity. Eye shadow containers, lip gloss containers, and plastic cold cream jars are very popular. For safety reasons, glass jars should be avoided. If they break, you might get a nasty cut from the glass.

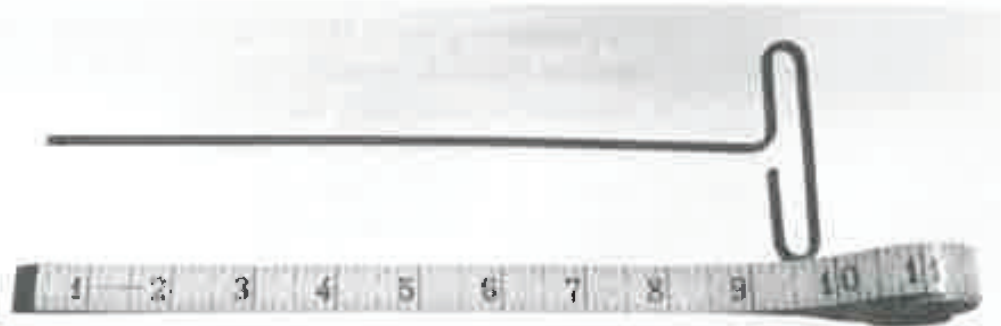

Figure 1-3 A long-reach T-handle hex key with a $\frac{7}{64}$ -inch tip and a 9-inch arm.



Figure 1-4 A precision ground flat-head screwdriver with an $\frac{1}{8}$ -inch wide blade and an 8-inch long shaft.

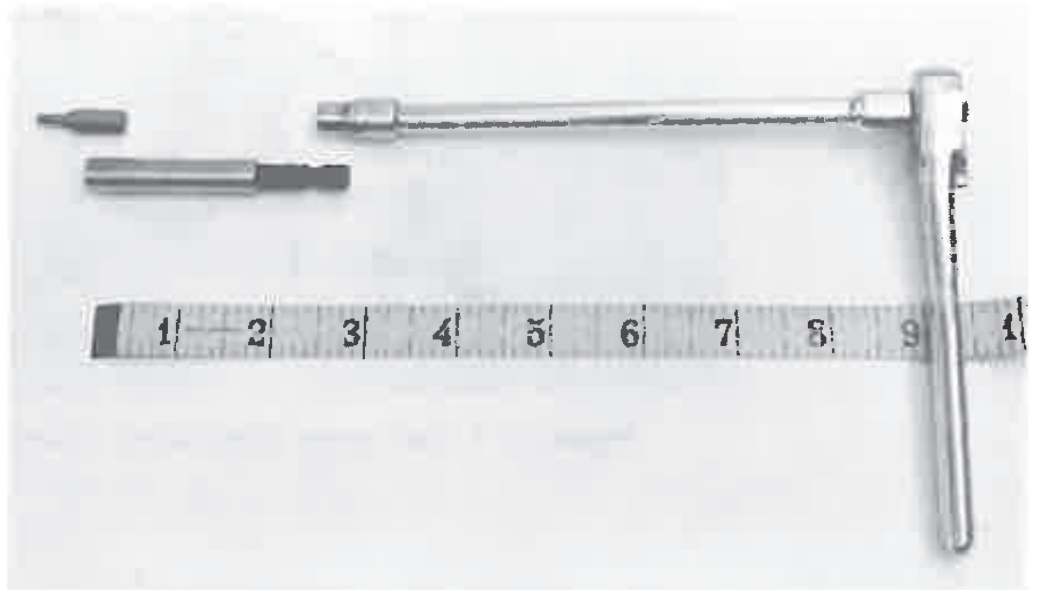

Figure 1-5 A $\frac{1}{4}$ -inch drive mechanic's ratchet with a 6-inch long extension, a $\frac{1}{4}$ -inch socket, a $\frac{3}{8}$ -inch OD (outside diameter) bit holder, and a T-15 insert bit.

Take-Apart Procedure

Once the screws are out, you'll need a 1-inch spring clamp to pop the case as shown in Figure 1-6. In dire emergencies, you can also use a #4 letter clip as shown in Figure 1-7.

When popping the case, keep the tool moving and try to take tiny bites. If you hold the tool in one place and try to pop the case with a single bite, it won't work and you'll just chew up the grooves. This looks terrible as shown in Figure 1-8.

After popping the case, pull the rear cover straight up. At this point, two oddly shaped parts may fall out. The first is a 9-inch long, L-shaped aluminum-colored RFI (radio frequency interference) shield. This shield fits over the I/O connectors—the mouse, disk drive, printer, modem, speaker, and SCSI (small computer systems interface) ports—at the back of the computer. If you don't see it, it's probably still attached to the logic board as shown in Figure 1-9.

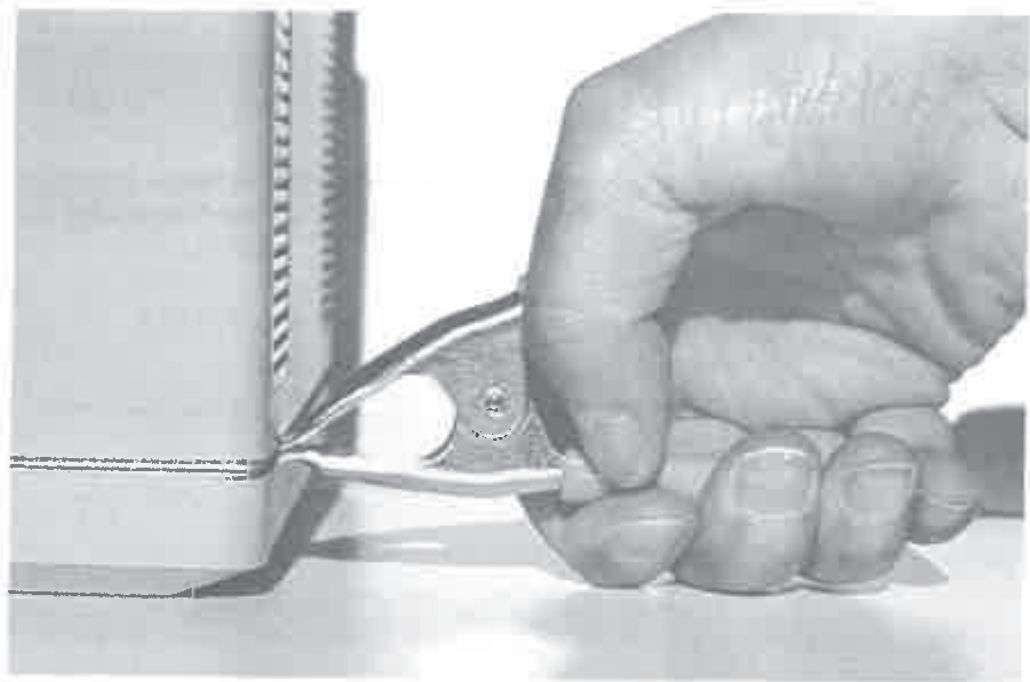

Figure 1-6 A 1-inch spring clamp makes an excellent case popper.



Figure 1-7 In dire emergencies, you can also use a #4 letter clip.

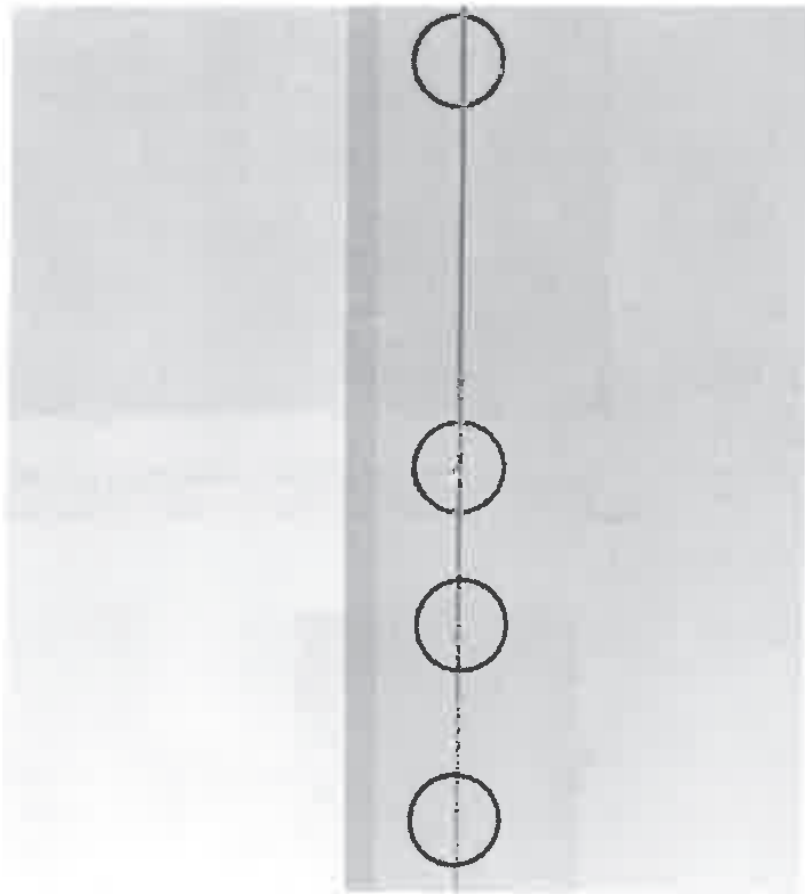

Figure 1-8 Keep the tool moving or you'll just chew up the grooves.

The second part is a small grounding spider. This part is about the size of a quarter and fits over a plastic fin on the left inside of the rear cover (128K to Mac Plus, only). The spider's function is to discharge static electricity through the ground trace on the power-supply board. Since it's not at all

obvious where this part goes, you should look for it and note the correct location before proceeding. If you don't find it now and it falls out later, you may never figure out where it goes! Look for it inside the rear case (128K to Mac Plus, only) near the power switch opening as shown in Figure 1-10.

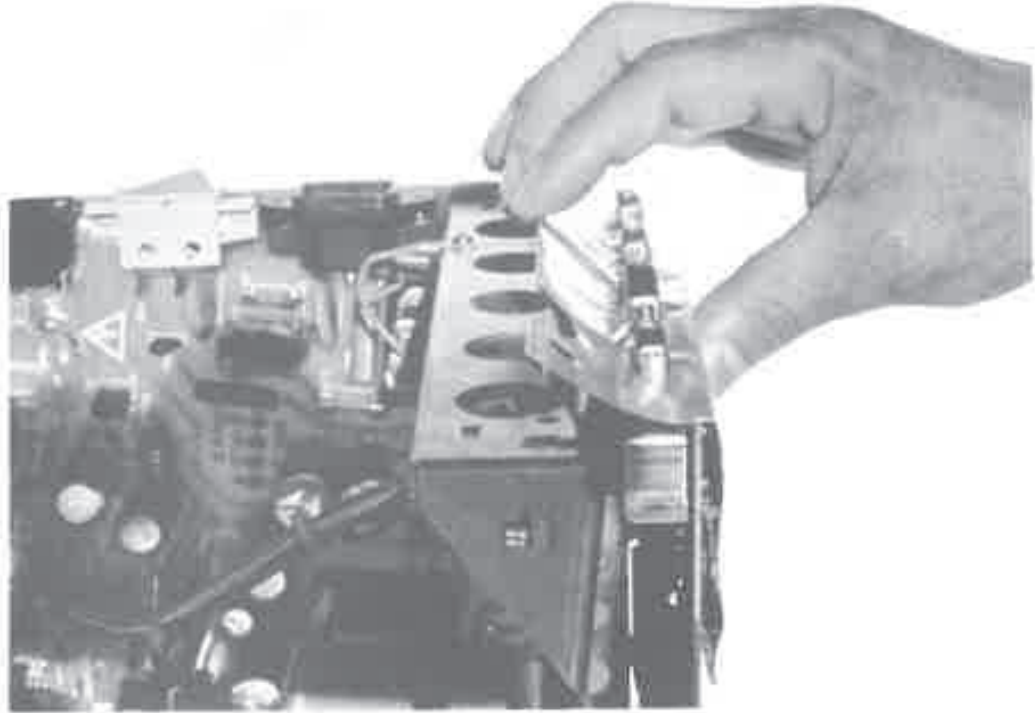

Figure 1-9 The RFI shield is a 9-inch long, L-shaped piece of aluminum-colored material that fits over the I/O connectors on the logic board.

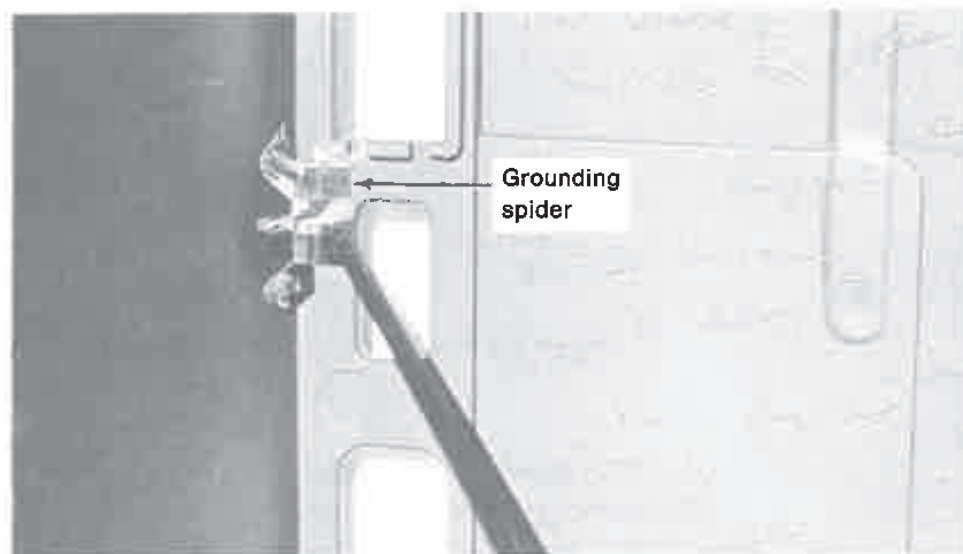

Figure 1-10 The grounding spider fits over a plastic fin near the power switch opening (128K to Mac Plus, only).

As shown in Figure 1-11, the power-supply board is connected to the chassis by three #1 Phillips-head screws. One is located 3 inches up from the bottom right corner of the board. Two are located at the lower left corner of the board. Most power-supply repairs can be effected without removing the board, but for those repairs that do, you'll need a #1 Phillips-head screwdriver.

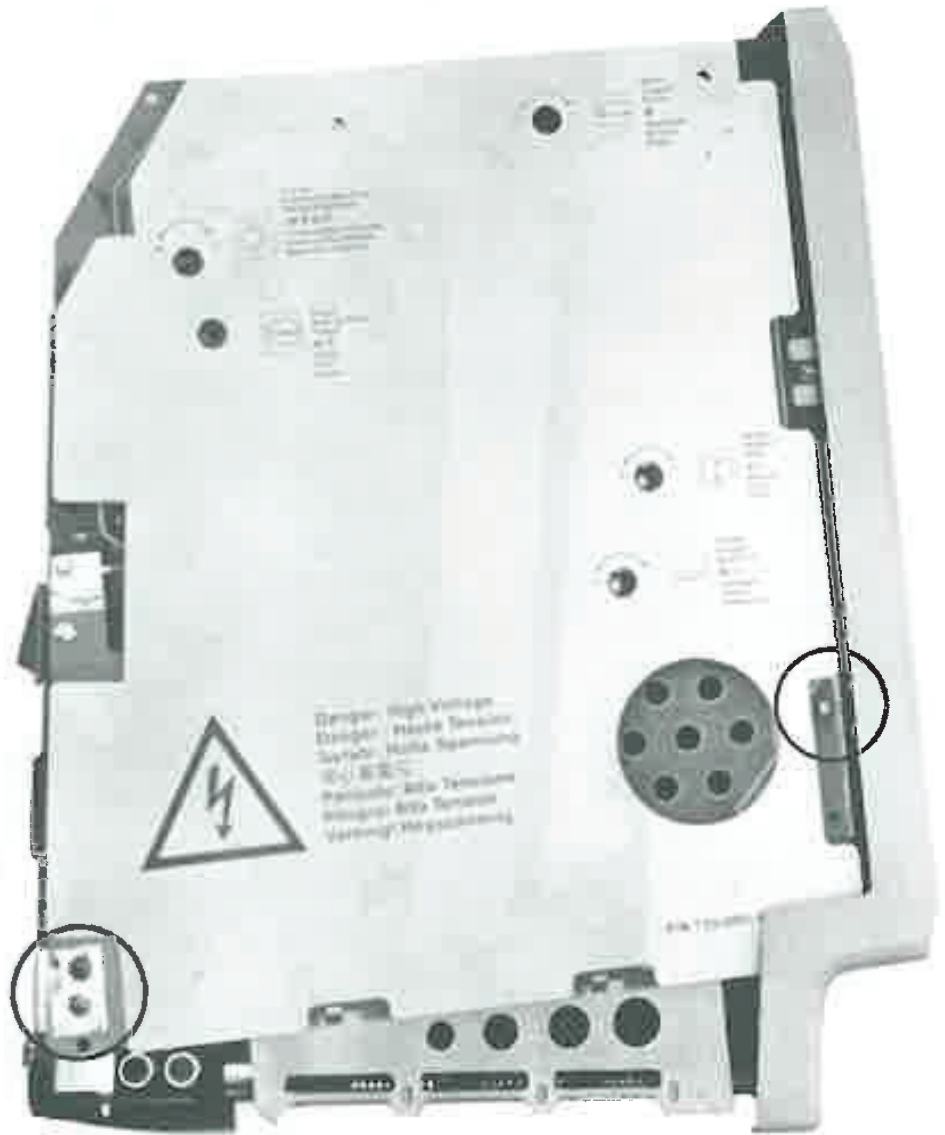

Figure 1-11 The power supply is connected to the chassis by three #1 Phillips-head screws. One is located 3 inches up from the bottom right corner of the board. Two are located at the lower left corner of the board.

Note the high-voltage lead which runs from the flyback transformer to the picture tube. As shown in Figure 1-12, it's the one that ends in a suction cup. Before removing the power supply board, this lead has to be safely

discharged and disconnected. As shown in Figures 1-13 and 1-14, you can convert a long-handled $\frac{1}{8}$ -inch screwdriver into a CRT discharge tool by fitting it with some insulating tubing, a clip lead, and a 10-megohm resistor.

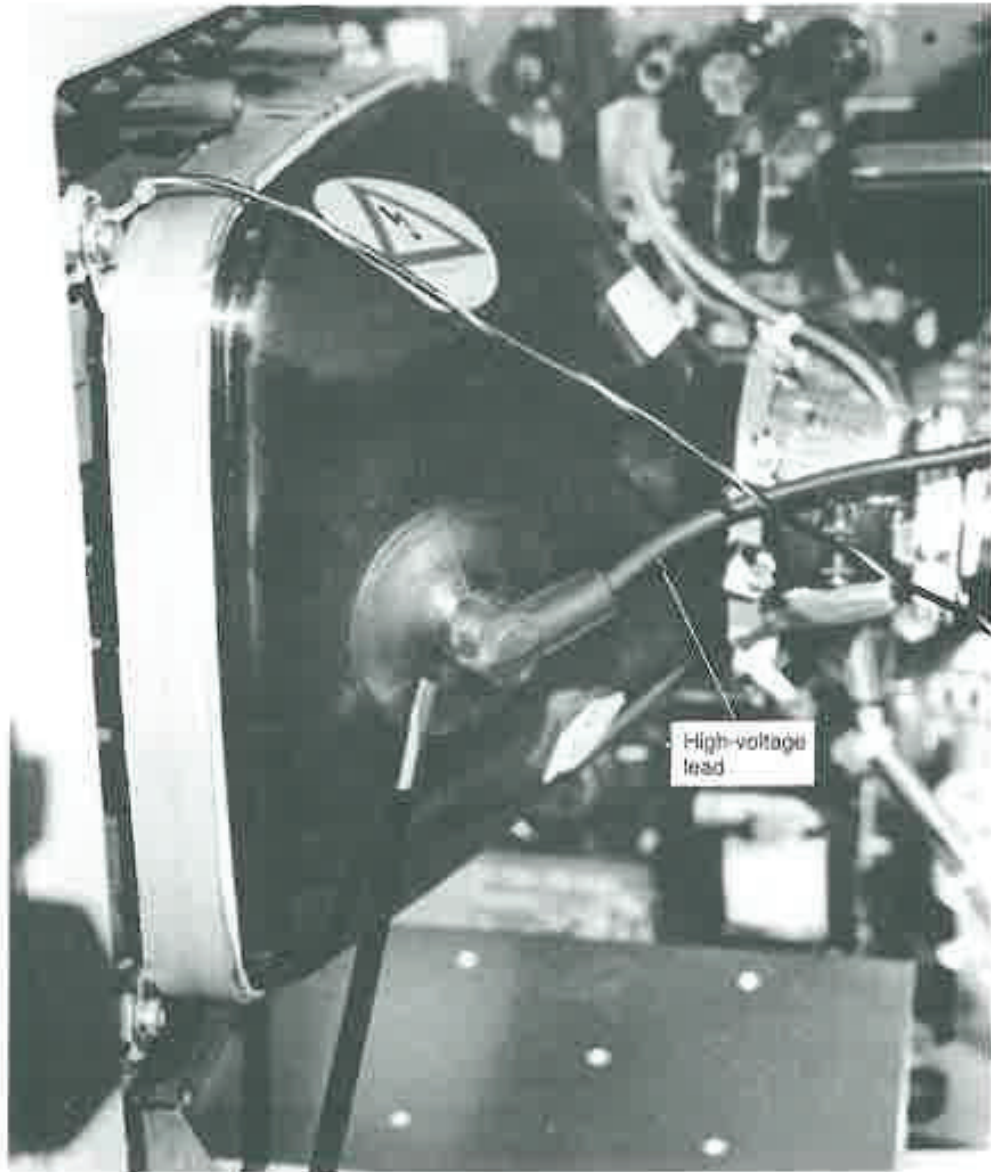

Figure 1-12 The high-voltage lead runs from the flyback transformer to the picture tube. It's the one that ends in a suction cup.

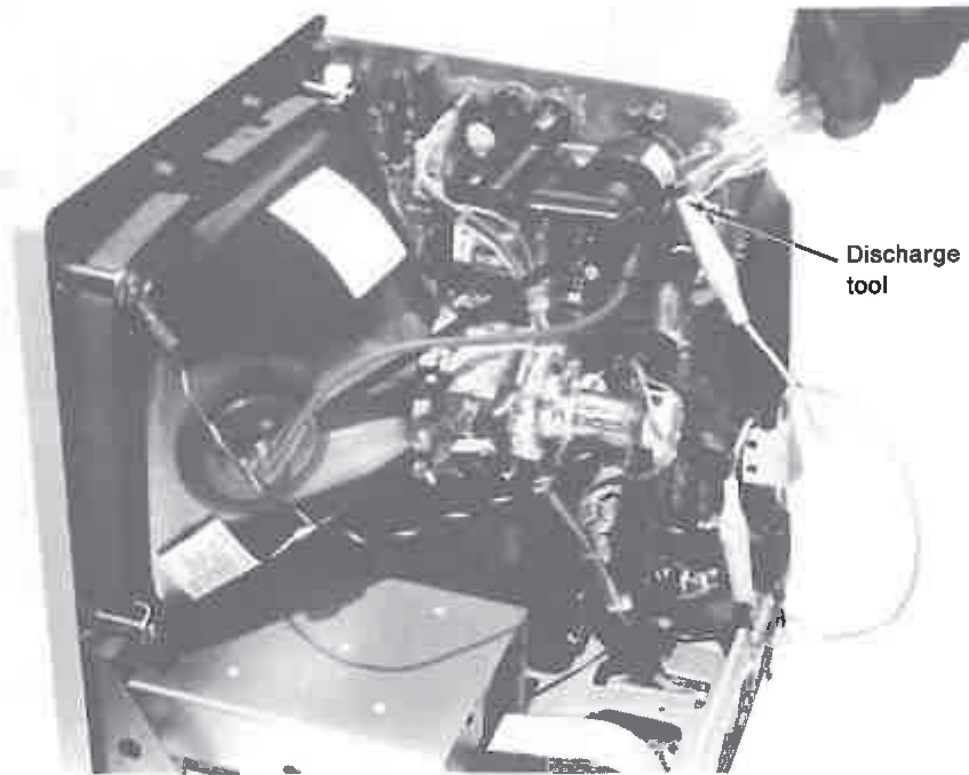

Figure 1-13 You can discharge the picture tube with an insulated long-handled screwdriver, a green clip lead, and a 10-megohm resistor.

The 10-megohm resistor allows you to drain the electrical charge slowly. Without it, you'll get a big spark which is potentially dangerous not just to you, but also to the CRT. An easy-to-make custom discharge tool is shown in place, in Figure 1-15. This tool is made from an insulated test probe, a green clip lead, and a 10-megohm 1/4-watt resistor. To make your own tool, cut off one end of a green clip lead, unscrew the test probe handle, slip the handle over the wire, and cut the resistor leads to size. When you screw the handle back on, the resistor leads should be completely insulated by the test probe. There can't be any exposed metal. Readjust the leads as necessary, then solder everything together. For safety, cover the entire tool with heat shrink tubing. Never unscrew the handle while the tool is in use!

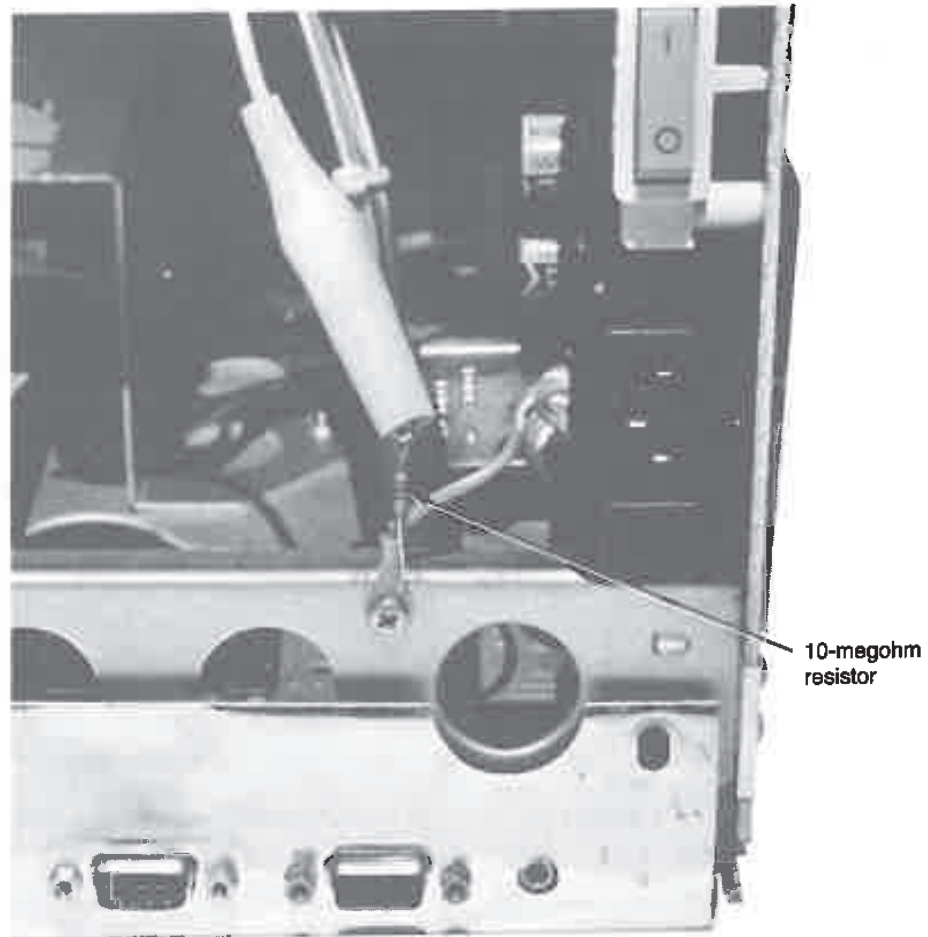

Figure 1-14 Resistor detail. Clip lead attaches to the 10-megohm resistor. Resistor connects to the chassis.

For safety, cover the entire tool with heat shrink tubing, right down to the tip. Never grab the exposed metal at the tip. Never unscrew the handle while the tool is in use.

Because of the implosion danger, most textbooks also advise wearing safety goggles. In theory, that's a good idea, but in practice most goggles fog instantly. It's quite a challenge finding a pair that doesn't.

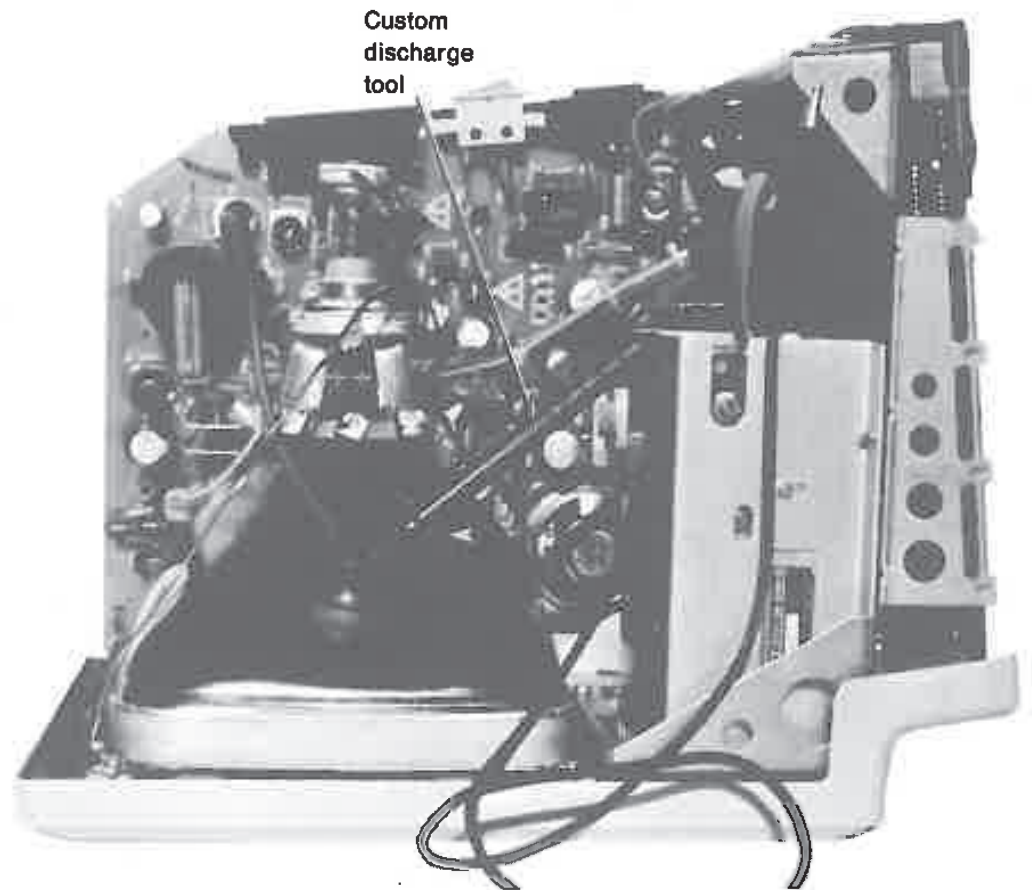

Figure 1-15 An easy-to-make custom discharge tool.

Test Equipment

Adjusting the video (the height, the width, and so on) requires a set of plastic TV alignment tools and at least a 20,000 ohms per volt multimeter. Don't be tempted to use a cheaper 2,000 ohms per volt meter. These may be fine for appliance and automotive servicing but they're completely unsuitable for board work. Anything rated less than 20,000 ohms per volt becomes part of the circuit you're testing which results in consistently false readings.

For Macintosh work, 20,000 ohms per volt sensitivity is the minimum requirement. Better meters, including most digital VOMs (volt ohm meters) are rated at 10,000,000 ohms per volt! Buy the best meter you can afford. You won't regret it!

Here's a list of the essential features to check when picking a multimeter:

1. At least 20,000 ohms per volt input sensitivity (also called impedance).
2. An $R \times 100$ (resistance times 100) scale for testing transistors.
3. A 0 to 10 volts DC scale for testing dry cells.
4. Easily replaceable batteries (like 9-volt or AA cells).
5. Flexible, nontangling test leads.

Other handy features include:

6. Autoranging numerical read out.
7. Capacitance checker.
8. Audible continuity test.
9. Frequency counter.
10. High-voltage accessory probe.

Analog multimeters have a needle pointer and a scale. Digital multimeters have a numerical readout. Both types of multimeters are shown in Figure 1-16. Plastic TV alignment tools are shown in Figure 1-17.

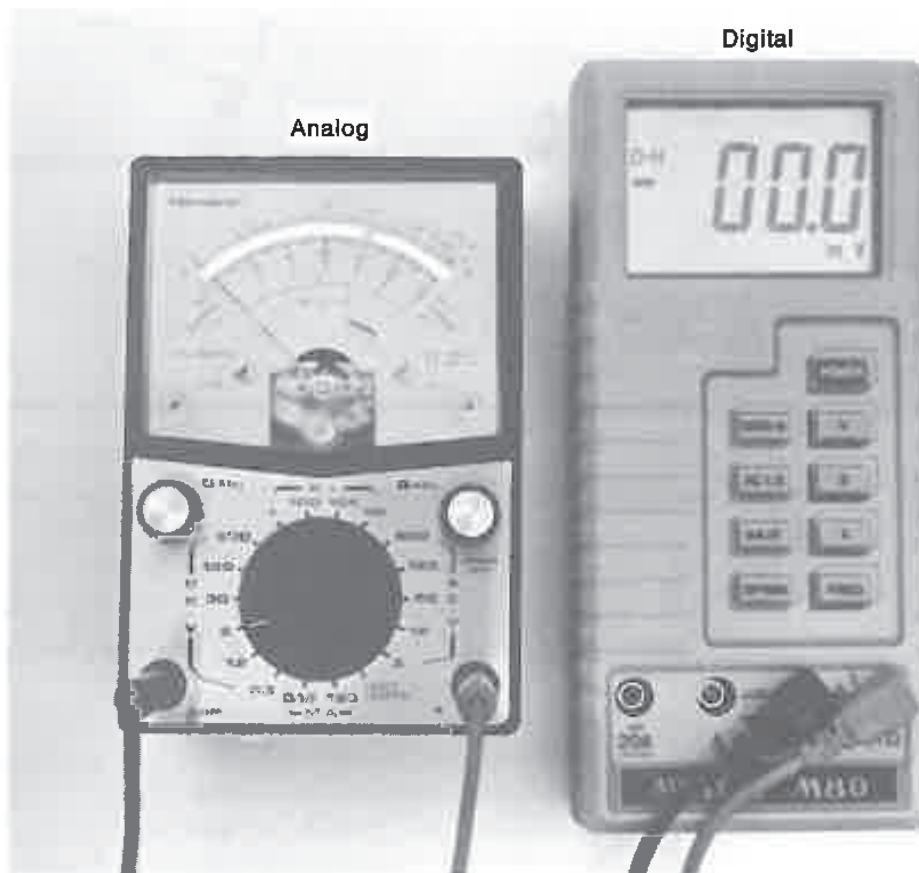

Figure 1-16 Analog multimeter has a needle pointer and a scale. Digital multimeter has a numerical readout.

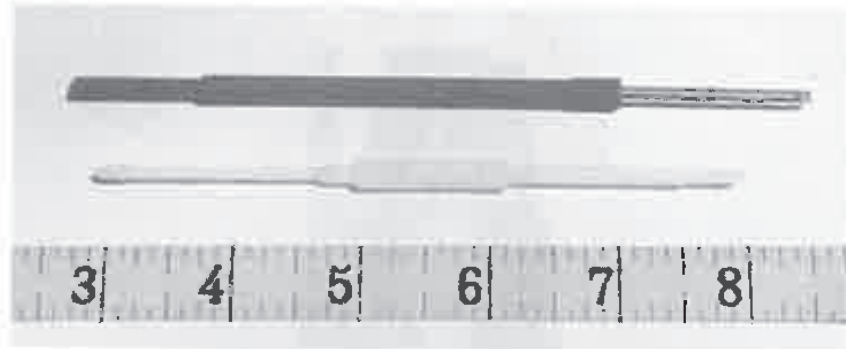

Figure 1-17 Plastic TV alignment tools.

Soldering Equipment

Naturally, parts that test bad have to be desoldered and replaced. For that you'll need a grounded (three-wire) soldering pencil, a roll of 60/40 rosin core solder, and a vacuum desoldering tool. Don't be tempted by cheap ungrounded (two-wire) soldering pencils. Ungrounded pencils are fine for soldering cables and connectors, but they're completely unsuitable for digital work. In an informal study of ungrounded soldering pencils, engineers at the local university measured tip voltages as high as 67 volts AC. Most ICs (integrated circuits) are designed to work at 5 volts DC. Applying 67 volts AC to a component rated at 5 volts DC is a surefire way to destroy it. Both types of soldering pencils are shown in Figure 1-18.

Diagnostics Software

Now a word about Test Pattern Generator (TPG), the comprehensive diagnostics program that's included with this book. As a result of heat and old age and maladjusted upgrades, a large number of older computers now have shrunken video. Instead of a normal-sized display, there's a large black border all around. Instead of a well-focused display, certain areas are fuzzy. Left untreated, the image becomes distorted, tilted, or off-center. Eventually, the display collapses to a vertical line or the set fails altogether.

Test Pattern Generator helps you treat these problems. It creates precision alignment patterns just like the dot-bar generators used in television repair. By measuring the patterns with a ruler, you can determine what (if anything) needs to be done. Simply running the program does not fix the set! For that you also need detailed instructions, alignment tools, and a multimeter. Detailed instructions are in the chapters that follow.

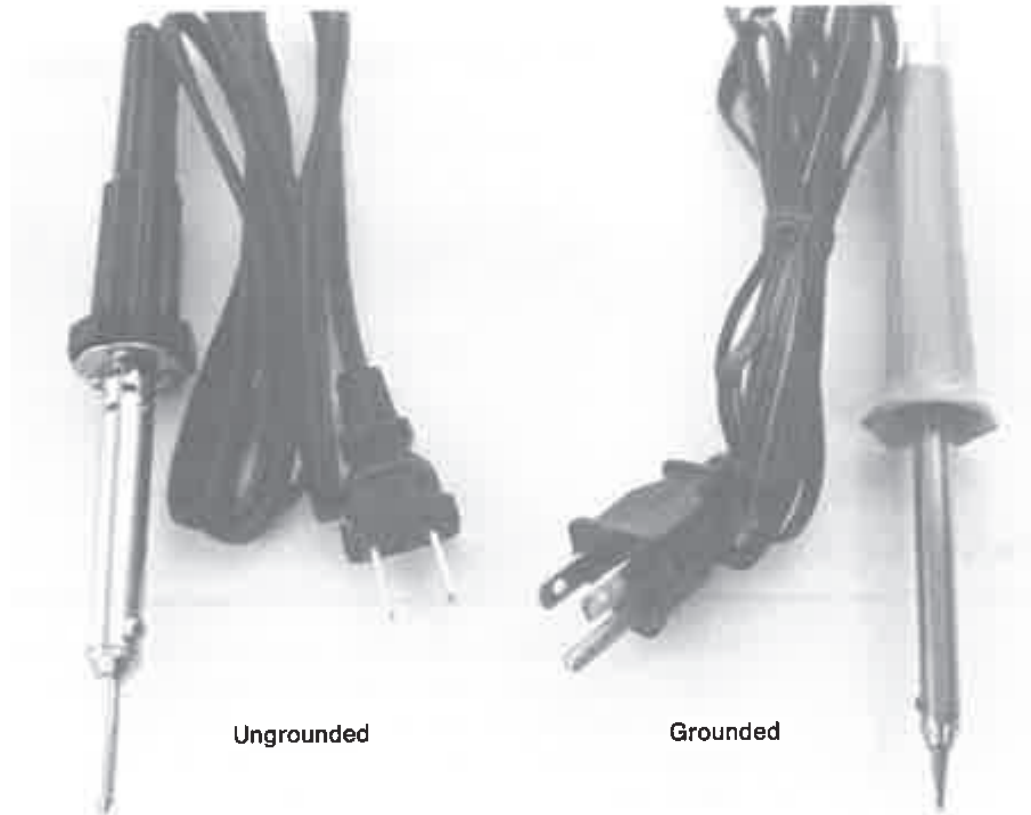

Figure 1-18. Ungrounded soldering pencil has a two-wire plug. Grounded type has a three-wire plug.

System Software—Setting Up Workdisks

To work on all of the Macintosh models covered in this volume, you'll need to set up three System disks. Two are 400K disks based on System version 2.0 (dated April 1985) for use on 128K to 512K Macs, Lisas, and Mac XL's running the old MacWorks 3.0/MacWorks XL. The other should be an 800K disk based on System version 4.2 (dated August 1987) for use on 512K Enhanced Macs, the Mac Plus, the Mac SE and upgraded Lisas, and Mac XL's (with 800K drives) running MacWorks Plus.

For general use, it's very important that you use the recommended versions of the System and Finder. These have been extensively tested and are known to work properly "across the board" on all of the above models. But for use on a specific computer (say your own machine), you can safely substitute whatever version of the System and Finder came with it. It's OK, for example, to use System version 3.2 on a Mac Plus but not on an original

128K Mac. That combination results in a SadMac icon with error #0F 000A. Likewise, you can use System 2.0 on a Macintosh Plus, but not on a Macintosh SE Hard Disk 20. That rearranges the HFS directory on the internal hard drive.

It's also important that you start with absolutely new disks and virgin copies of the System software. Add-on inits, F-Keys, and menu clocks should be avoided. These may not work properly on all machines. In particular, bench technicians should avoid the MiniFinder. Once the MiniFinder's been installed, your disk will never run on a Lisa/Mac XL under MacWorks 3.0, not even if you remove it and reinstall Finder 2.0. That's not well known. You can spend hours looking for problems that just aren't there. There are other bizarre anomalies. When setting up System disks for use on the repair bench, always go with the least common denominator—standard Apple System software, no MiniFinder.

The Test Pattern Generator disk contains two versions of the program. 128K-TPG is a slim version for 128K Macs, only. If you have a 128K Mac or if you plan to service them, copy it to one of the 400K System disks and label the disk "128K-TPG, for 128K Macs only." 512K-TPG is for all other Macs. If you have an older Mac with a 400K disk drive, or if you plan to service them, copy 512K-TPG to the other 400K System disk and label it "512K-TPG, for 512K Macs, Lisas and Mac XL's with 400K drives." Finally, if you have a newer Mac with an 800K disk drive, or if you plan to service them, copy 512K-TPG to the 800K System disk and label it "512Ke-TPG, for the 512K Enhanced, the Mac Plus, the Mac SE, upgraded Lisas and Mac XL's." Bench technicians should make all three disks. If you bought *Macintosh Repair & Upgrade Secrets* for your own use, you really only need to make one disk, whichever is appropriate for your particular machine.

After copying Test Pattern Generator to all three System disks, it's best to make a set of backup copies. Use one set of disks for everyday work. Use the backup copies to make replacements as needed. Store the master Test Pattern Generator disk in a safe place, preferably somewhere away from the workbench. In rough use, you have to expect disk casualties. If the master disk is nowhere at hand, you'll always have something to fall back on.

Choosing a Work Area—Setting Up the Bench

Every now and then, I hear from someone with such an intriguing problem that I decide to make a house call. Invariably, that person leads me to an ordinary desk covered with pencils and papers, points to a computer on that desk, and says, "There it is!" Absolutely no provision has been made for tools, outlets, lighting, and so on. It's like asking a surgeon to operate without an operating room.

Even minor repairs require a clean work area. There should be lots of room for tools, subassemblies, and manuals. Unused electrical outlets should

be readily available. You shouldn't have to unplug the only source of light to plug in a soldering iron. An old towel should be laid out to protect the surface of the CRT. A nonflammable trash can should be nearby. A crowded, poorly lit desk covered with flammable material is not the place to repair a computer. Safety requires you to set up properly beforehand!

Summary

Repairing the Macintosh requires a modest investment in test equipment. At the very least you need the following:

1. A pair of nonfogging safety goggles.
2. A T-15 screwdriver with an 8-inch shaft.
3. A small spring clamp.
4. A 10-megohm resistor.
5. A set of insulated (alligator) clip leads.
6. A 20,000 ohms per volt multimeter.
7. A grounded (three-wire) soldering pencil.
8. A roll of rosin core solder.
9. A desoldering tool.
10. A #1 Phillips-head screwdriver.
11. A set of plastic TV alignment tools.

Without these items, you can still diagnose problems, but you're not going to be able to fix anything.

Before attempting repairs, it's important to realize that risks are involved. The Macintosh runs on electricity. Electricity is inherently dangerous. The standard, textbook safety precautions must be taken at all times. Whenever there's something that you don't understand, stop! Seek further instruction or defer to qualified personnel.

CHAPTER



Preliminary Checks

This chapter outlines a preliminary checkup procedure. It assumes that you've made a TPG/System disk as instructed in Chapter 1, and it assumes you have a working set. That doesn't necessarily mean a perfect set, just one that will turn on and bring up the display. If you have a completely dead set, or one that won't bring up the display, skip ahead to Chapter 6 to get it going again. Afterwards, return here for further instructions.

Objectives

In order to tune up a Macintosh, you have to know what it's supposed to do. You need to know what the operating voltages are, what the height and width adjustments should be, and you need to know how to set them. Soon, you'll know how to do all of that! Below is a preliminary checklist. Make a blank copy on scratch paper before proceeding. As the chapter progresses, you'll learn how to fill it out:

Preliminary Checklist

Model ID and Configuration Data:

Macintosh type (from cabinet): 512K

Serial number (from cabinet): 123456789

Drive capacity (as inspected): 800K

Total installed memory (as indicated by the Finder): 1024K

ROM version (as indicated by TPG): Enhanced ROMs

Video Data:

Specified height (as indicated by TPG): 4.75 inches

Actual height (as measured): 4 $\frac{3}{8}$ inches

Difference: $\frac{3}{8}$ inch short

Specified width (as indicated by TPG): 7.11 inches

Actual width (as measured): 6 $\frac{3}{4}$ inches

Difference: $\frac{3}{8}$ inch short

Specified diagonal (as indicated by TPG): 8.55 inches

Actual diagonal (as measured): 8 inches

Difference: $\frac{1}{2}$ inch short

Linearity test: narrow on the left; wide on the right

Circularity test: circles are vertically elongated

Centering test: favors the bottom left

Balance test: vertical intensity is much darker

Focus test: upper right corner is very bad

Power Supply Data:

+5-volt test: 4.93 V

+12-volt test: 12.42 V

-12-volt test: -12.32 V

Technician Data:

Set tested by: Larry P.

Using: 512K-TPG version 1.18

Date: Monday, September 25, 1989

First Step—Which Macintosh?

As explained in Chapter 1, the master TPG disk contains two versions of the program. 128K-TPG is for "classic" 128K Macs. 512K-TPG is for all other models. Since 512K-TPG doesn't run on stock 128K Macs, the first step (assuming you know nothing about the machine you're about to work on) is to find out which model of the Macintosh it is. This is easily done by checking the back of the cabinet as shown in Figure 2-1. Original 128K models are simply marked "Macintosh." Late model 128K's are marked "Macintosh 128K." All other models are similarly marked. If you see Macintosh 512K, Macintosh 512Ke, Macintosh Plus 1024K, Macintosh SE 1024K, etc., it's safe to assume that you've got at least that much memory; you can proceed with

512K-TPG. Otherwise, proceed with 128K-TPG on the assumption that it's a classic 128K machine.

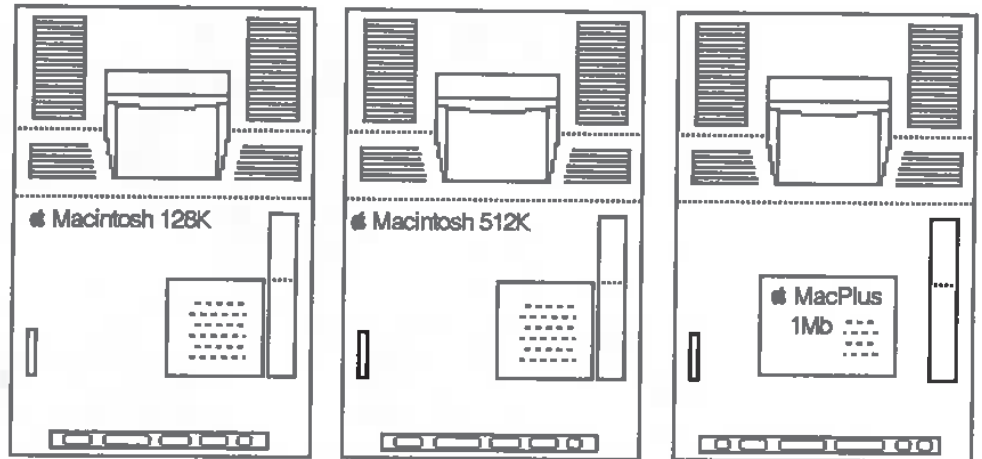

Figure 2-1 The easiest way to identify Macintosh models is to check the back of the cabinet.

Drive capacity (400K or 800K) must also be determined. Machines marked "Macintosh 512Ke," "Macintosh Plus," or "Macintosh SE" will always have 800K drives, but older machines marked "Macintosh 512K" or "Macintosh 128K" may have either drive. The same is true for Lisas and Macintosh XL's. The best way to determine drive capacity on these machines is to play it by ear. Insert the 128K-TPG disk and switch on the computer. 400K drives sound like egg beaters. 800K drives make occasional, authoritative beep noises. If these sounds aren't familiar to you, switch on the set and look into the empty drive opening. 400K drives have an orange LED (light emitting diode). 800K drives don't. Incidentally, the presence of an 800K drive in an older Macintosh (one simply marked "Macintosh" or "Macintosh 128K") is a sure sign that the machine has been upgraded, usually to 512K or better. In that case, shut down and try booting the 512K-TPG system disk. If for some reason you guess wrong, and the disk gets kicked out, switch off and start over with 128K-TPG. Of course, most people know exactly which model of the Macintosh they own. Still, this information may come in handy if you're ever faced with a broken "mystery" machine.

After booting successfully, it's a good idea to check the total installed memory. This is easily done by choosing About the Finder from the Apple menu as shown in Figures 2-2 to 2-3. The exact style of the resulting dialog box depends on which version of the Finder you're running. The dialog box shown in Figure 2-3 is from Finder 5.3. All styles indicate how much memory is installed. If 128K is indicated, click the close box and proceed with 128K-TPG. If 512K or more is indicated, click the close box and proceed with 512K-

TPG. Much of the time, 512K or more will be indicated because many (perhaps most) 128K machines have been upgraded.

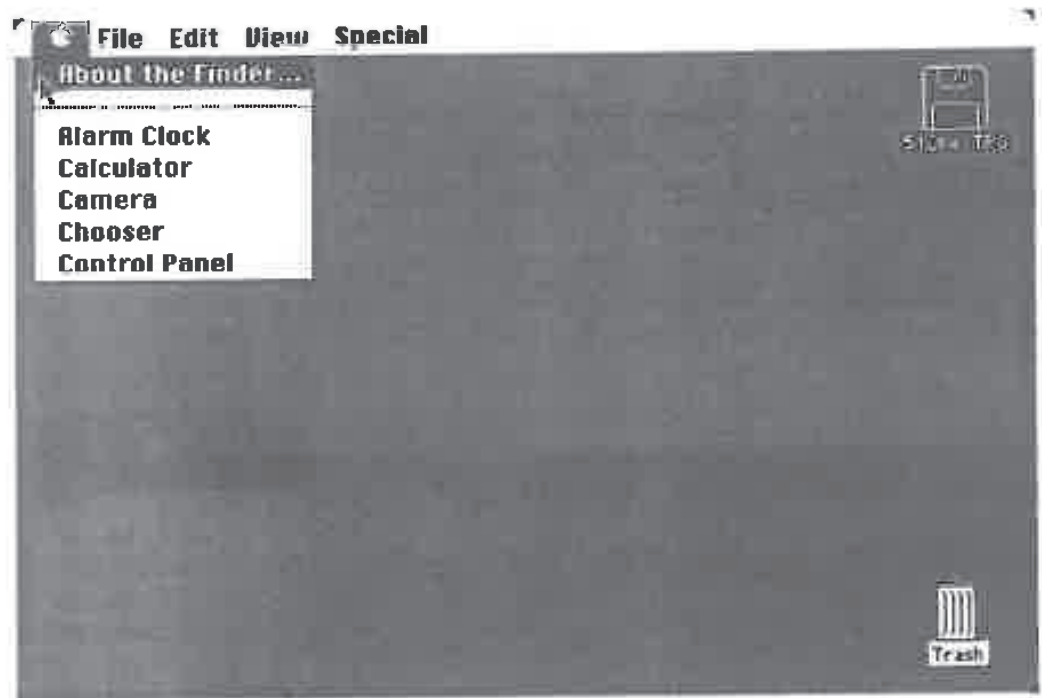

Figure 2-2 Choosing About the Finder from the Apple menu.

The serial number is on the bottom of the cabinet. For reference, enter it on your preliminary checklist along with the model number, the drive capacity, and the amount of total installed memory before proceeding.

Starting Test Pattern Generator

After determining the total installed memory, double-click the appropriate TPG icon (128K-TPG or 512K-TPG), or simply select it and choose Open from the File menu. The first thing you should see is a sign-on screen showing memory and ROM (read only memory) information. Copy the ROM version to the worksheet. To dismiss the sign-on screen, click and hold the mouse button down (until the sign-on screen disappears) or just press the Return key. Assuming a copy of 512K-TPG that's never been used before, the next thing you should see is a list of General Instructions as shown in Figure 2-4.

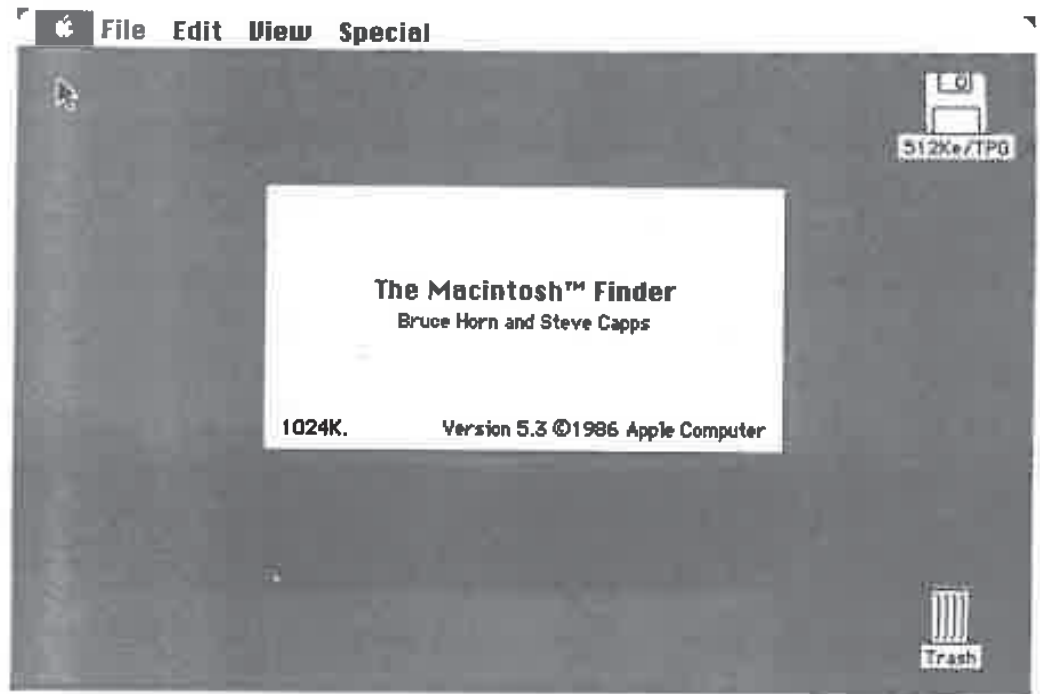

Figure 2-3 About the Finder tells you how much memory is installed. This machine has 1024K.

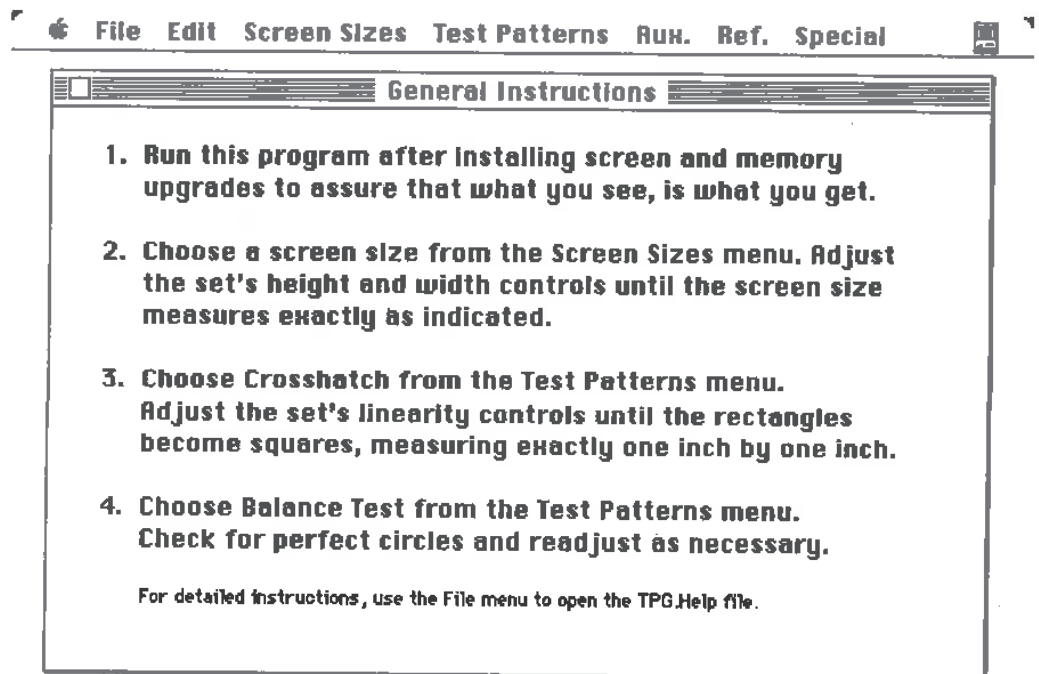

Figure 2-4 General Instructions.

After reading the instructions, you can close the window by clicking the close box, by choosing Close from the File menu, or by typing Command W. You can refer to this list anytime you wish by rechoosing it from the Reference menu.

Choosing a Screen Size

Next, choose a screen size from the Screen Sizes menu. 128K-TPG contains only one size—9-inch Std. Macintosh. 512K-TPG contains several, for use with 12-inch Lisas, 12-inch XL's and various size external monitors as shown in Figure 2-5.

Note that the keyboard equivalent for Macintosh is Command M. The keyboard equivalent for Lisa/XL Screen Kit is Command L. Apple's external monochrome monitor is Command N. Apple's external RGB Monitor is Command B. Typing Command U returns a dialog box where you can enter unlisted screen sizes. In most cases, the size you want is 9-inch Std. Macintosh. Once you've chosen a size, TPG calculates and displays T-squares as shown in Figure 2-6.

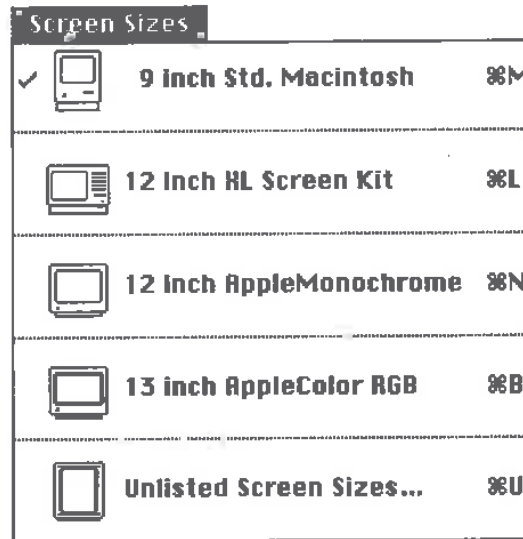

Figure 2-5 The Screen Sizes menu.

Values specified on the T-squares for listed monitors are accurate to $\frac{1}{100}$ of an inch. Values specified for unlisted monitors are also accurate to $\frac{1}{100}$ of an inch, but TPG relies on whatever data you supply via the Unlisted Mac

Monitors... dialog box. Initially, the default values are read in from the Macintosh toolbox, so in most cases all you have to do is click the OK button (or press the Return key) to proceed. With stock Lisas and Macintosh XL's, that's all you have to do—choose Unlisted Mac Monitors... (because the stock Lisa/XL is not specifically listed on the screen sizes menu) then click the OK button (or press the Return key) to proceed.

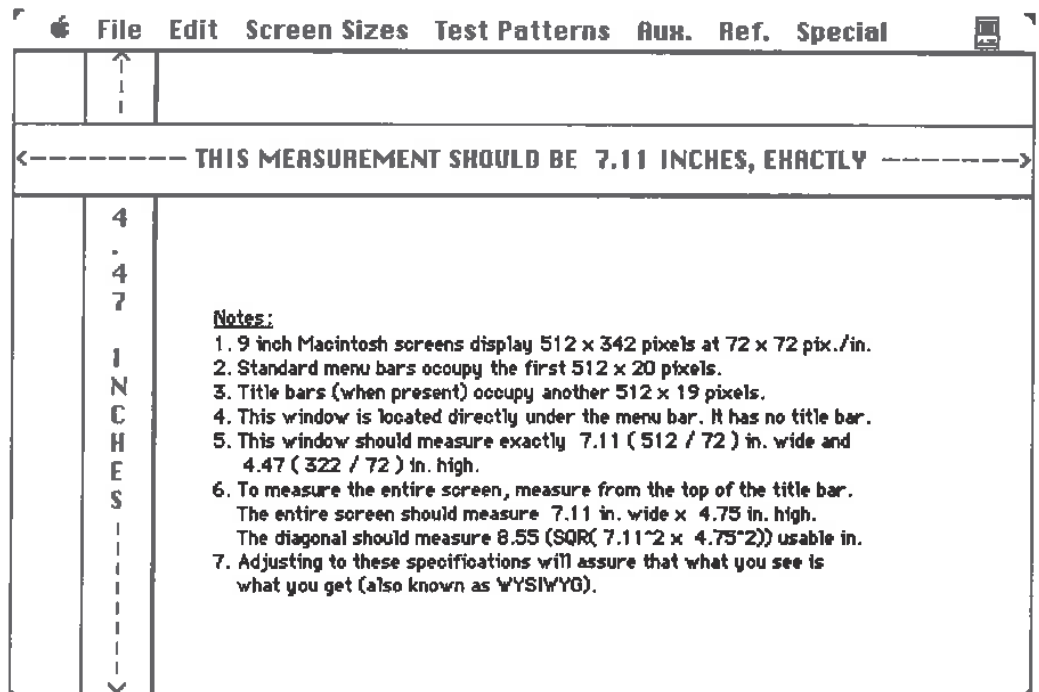

Figure 2-6 T-squares specify height and width values.

Sometimes, especially with unlisted external monitors, the dpi (dots per inch) values may not be passed correctly. In that case, the Unlisted Mac Monitors... dialog box suggests default values of 72 dpi. If you know these to be incorrect, type in the correct values. Whenever there's a discrepancy with an unlisted external monitor, always go with the manufacturer's published specifications. A partial list of published specifications is available under the Reference menu as shown in Figure 2-7.

File Edit Screen Sizes Test Patterns Run. Ref. Special					
Monitor Specifications					
MAKE	MODEL	HWidth	VHeight	DPI	
Apple Computer	15-Inch Portrait	640	870	80.0 x 80.0	
Apple Computer	21-Inch Two-Page	1152	870	77.0 x 77.0	
Apple Computer	Lisa 2; Mac XL	720	364	90.0 x 60.0	
* Cornerstone	FPD	640	860	80.0 x 80.0	
Dynamac	Dynamac SE	640	400	76.0 x 76.0	
E-Machines	The Big Picture	1024	808	85.0 x 85.0	
Monitorm	Viking 10/GS	1024	768	72.0 x 72.0	
Monitorm	Viking 2400	1280	960	72.0 x 72.0	
Nuvotech	EasyView	512	342	55.5 x 55.5	
* Princeton	MAX-15 Autosynch	800	560	88.0 x 88.0	
* Princeton	MAX-15 Autosynch	720	540	80.0 x 80.0	
* Princeton	MAX-15 Autosynch	640	480	72.0 x 72.0	
PowerA	MacLarger	512	342	55.5 x 55.5	
Radius	FPD-11	640	864	77.0 x 77.0	
Radius	TPD	1152	864	82.0 x 82.0	
Radius	Color Disp Sys	1152	882	82.0 x 82.0	
* Samsung	MP5671 FPD	640	860	80.0 x 80.0	
* Sony	Multiscan	800	560	88.0 x 88.0	
* Sony	Multiscan	720	540	80.0 x 80.0	
* Sony	Multiscan	640	480	72.0 x 72.0	

* Indicates Macintosh SE equipped with MultiScreen Video Card.

Figure 2-7 A partial list of monitor specifications is available from the Reference menu.

How the T-squares Work

The screen on a 9-inch Macintosh (128K to Mac SE) contains 175,104 luminous dots called pixels. According to official specifications, there are 512 pixels across the screen and 342 pixels from top to bottom. 512×342 equals 175,104 total pixels. Each pixel is supposed to measure $\frac{1}{72}$ of an inch, so 72 pixels should equal 1 inch. To determine the total width in inches, TPG divides 512 by 72 and the result is 7.11 inches. That's exactly how wide the usable area should be (7.11 inches), no more, no less. To determine the total height in inches, TPG divides 342 by 72 and the result is exactly 4.75 inches.

It's important to understand that the T-squares do not represent actual display measurements. They merely display calculations that indicate what the measurements should be. More often than not, the actual measurements are much shorter than specified. The only way to tell is to measure the display yourself.

Checking the Height and Width

When measuring a 9-inch Mac (128K to Mac SE), use the ruler we printed on the bookmark. Otherwise, take care to use a quality cloth ruler. Cheap rulers

have plastic end protectors haphazardly cemented to their first and last inches. Not only can their sharp edges scratch the screen, but the first and last inches are usually inaccurate. If necessary, start from the 10-inch mark and drop the first digit (11 inches would be 1 inch, 12 inches would be 2 inches, 13 inches would be 3 inches, etc.).

If you're working on an older machine, chances are the actual height and width (as measured by you) will be much shorter than specified by the T-squares. Sometimes, the actual height and width is so much shorter than specified that people just can't believe it! Read the on-screen instructions carefully. Regardless of what size screen you're working on, all of the math will be explained. For your own satisfaction, pull out a calculator and prove the math. Assuming you chose the correct screen size from the Screen Sizes menu (or typed in the correct values in the Unlisted Mac Monitors... dialog box), you'll find it's not the program that's in error, it's the set! In Chapter 3, you'll learn how to adjust the set. For now, just enter your preliminary measurements onto the worksheet.

Metric System

If you'd rather measure using the metric system, hold down the Option key when selecting a screen size. Holding down the Option key tells 512K-TPG to measure in centimeters rather than inches. TPG's metric T-squares are shown in Figure 2-8.

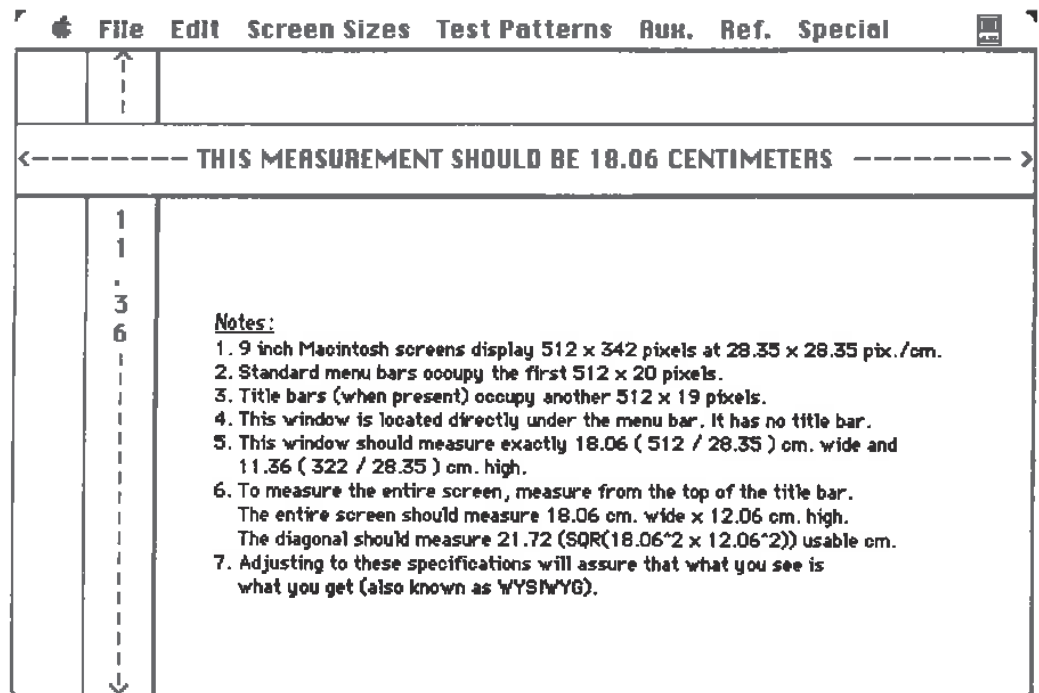

Figure 2-8 Metric T-squares (512K-TPG only) specify height and width values in centimeters.

Once you've selected metric T-squares, the metric system remains in effect for all subsequent tests. Whenever these instructions mention inches, you'll have to think centimeters because that's what's going to be displayed. To return to the English system of measurement, rechoose a screen size without holding down the Option key. While the program is running, you can switch measuring systems as often as you like. To switch measuring systems from the Unlisted Mac Monitors... and Set Startup... dialog boxes, hold down the Option key while clicking the OK button.

Checking Linearity

To check linearity, choose Crosshatch (Command G, for grid) from the Test Patterns menu. This hides the menu bar and brings up a full screen linearity grid as shown in Figure 2-9. The grid blocks should be exactly 1-inch square. If you're using the metric system, they should be exactly 1-centimeter square. Blocks on the left side of the screen should have exactly the same width as blocks on the right side of the screen. (Usually they don't!) Blocks at the top of the screen should have exactly the same height as blocks at the bottom of the screen. Write down your observations, then to restore the menu bar, click anywhere or press the Return key.

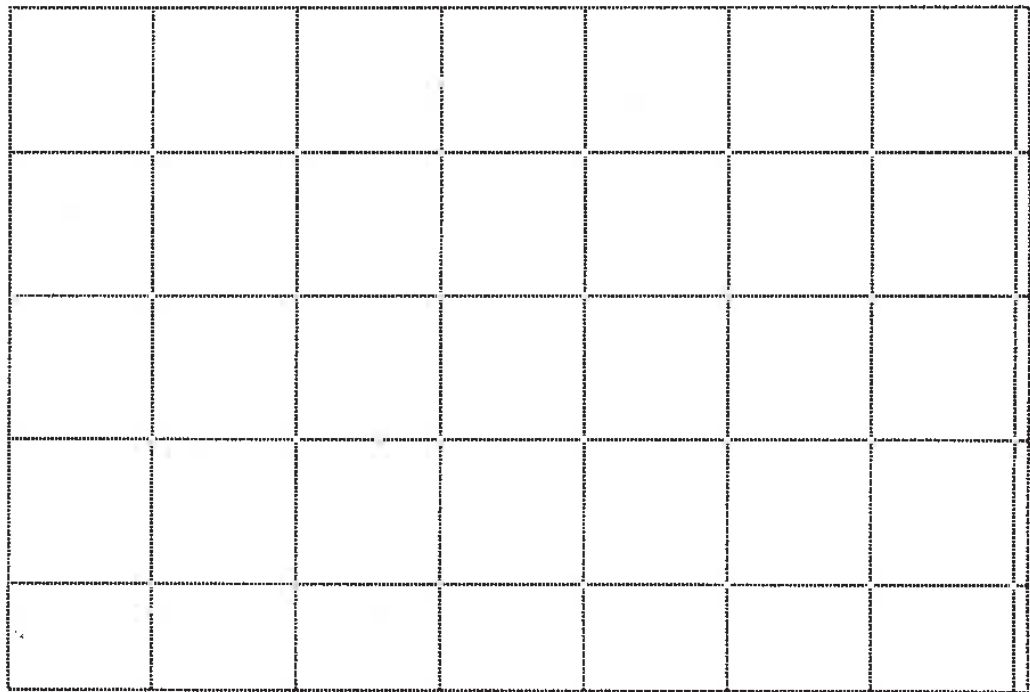

Figure 2-9 Crosshatch. The grid blocks should be exactly 1-inch (or if you're using the metric system, 1-centimeter) square.

Centering Test

Once the linearity has been evaluated, check screen centering by choosing Center Cross (Command Option X) from the Test Patterns menu (512K-TPG only). This test hides the menu bar, inverts the video, and sets up full screen cross hairs as shown in Figure 2-10.

The intersection of the cross hairs should be at the exact center of the screen. The easiest way to tell is to cut the diagonal with a string or a folded piece of paper. String is best for large (external) monitors; a folded sheet of paper works fine on small Macs. If the diagonal does not cut the intersection of the cross hairs, the adjustment is off. If the cross hairs are above the diagonal, it's off to the top. If the cross hairs are below the diagonal, it's off to the bottom. The centering may also be off to the left, or to the right, or in a combination of directions. Screen centering is a critical adjustment. If the centering is off, it's often very difficult (usually impossible) to get all four of the corners aligned. We'll be looking at that in the next chapter. For now, just write down your observations. Then, to restore the menu bar, click anywhere or press the Return key.

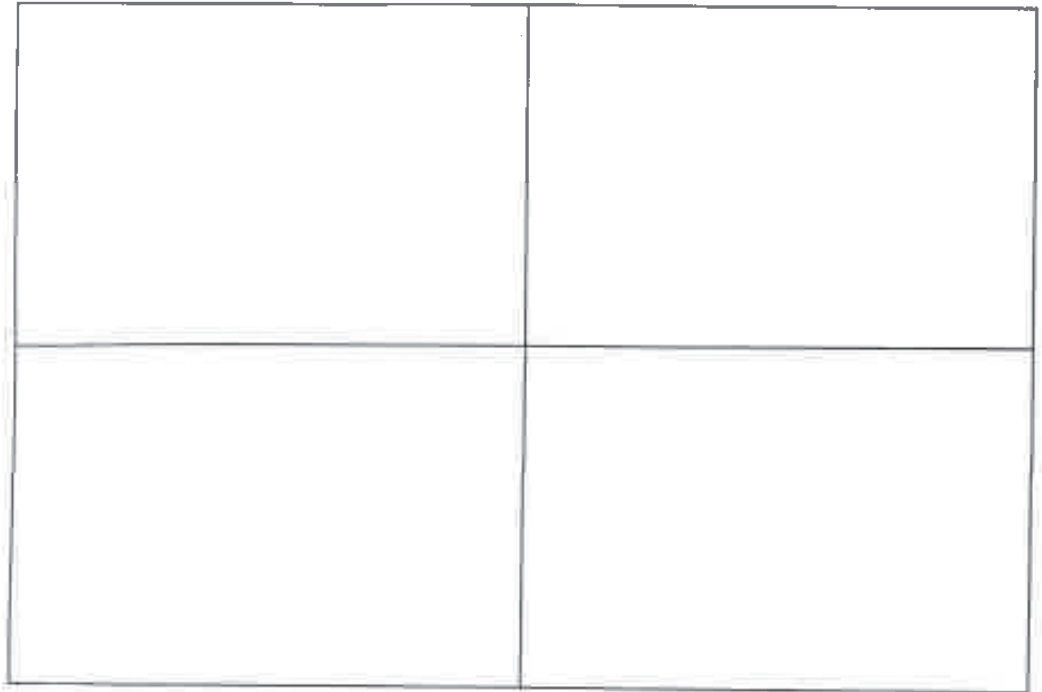

Figure 2-10 Center Cross. The intersection of the cross hairs should be at the exact center of the screen.

Checking Circularity

Once the screen centering is evaluated, choose Center Circles (Command R) from the Test Patterns menu (512K-TPG only). As shown in Figure 2-11, the rings should be perfectly round, not oval. The perimeters should be exactly $\frac{1}{8}$ inch apart. If you're using the metric system, they should be exactly $\frac{1}{2}$ centimeter apart.

You can move the rings around by pressing the cursor keys or, if you're working on an older Mac, by pressing the less < than (Shift Comma) and greater > than (Shift Period) keys. In 512K-TPG these keys work just like the Mac Plus's cursor keys. It's not necessary to hold down the Command key in order to use them. In fact, holding down the Command key actually prevents them from working. You can also move the pattern by clicking in the screen borders (512K-TPG only). Clicking in the leftmost $\frac{1}{4}$ inch moves the pattern left, clicking in the rightmost $\frac{1}{4}$ inch moves the pattern right.

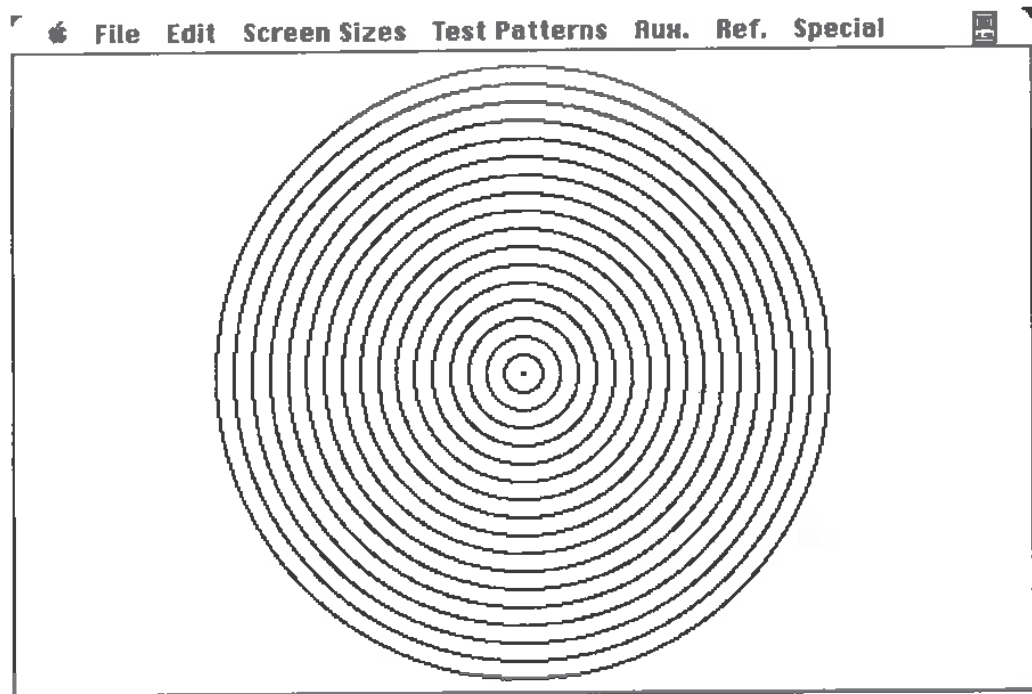

Figure 2-11 Center Circles. The rings should be perfectly round, not oval. The perimeters should be exactly $\frac{1}{8}$ inch (or if you're using the metric system, $\frac{1}{2}$ centimeter) apart.

With full page displays you can also move the rings up and down. Use the up and down keyboard arrows, or if you're working on an older Mac, use the {parentheses} (Shift [and Shift]) keys. Once again, in Test Pattern Generator these keys work just like the Mac Plus's cursor keys. It's not necessary to hold down the Command key in order to use them. You can also

move the pattern up and down by clicking in the screen borders. Clicking in the upper $\frac{1}{4}$ inch moves the pattern up, clicking in the lower $\frac{1}{4}$ inch moves the pattern down.

Note. Since only the upper left portion of the screen is visible when simulating large screen sizes on a small Mac, two of the "hot borders" (bottom and right) will always be off-screen. Under those circumstances, clicking at the bottom and to the right of the screen will not accomplish anything, but pressing the cursor keys will always work.

For a full-screen circularity test, hold down the Option key and rechoose Center Circles from the Test Patterns menu (512K-TPG only). As shown in Figure 2-12, this hides the menu bar and draws four additional test patterns. The smaller patterns are designed to check circularity in the corners relative to the center. All five of the test patterns should be perfectly round. All of the concentric rings should be exactly $\frac{1}{8}$ inch (or $\frac{1}{2}$ centimeter) apart. The two upper patterns should be exactly the same size as the two lower patterns. If one or more of the corner patterns looks like an egg, it's not the program! It's definitely a problem with the set. Note your observations on the worksheet, then to restore the menu bar, click anywhere or press the Return key.

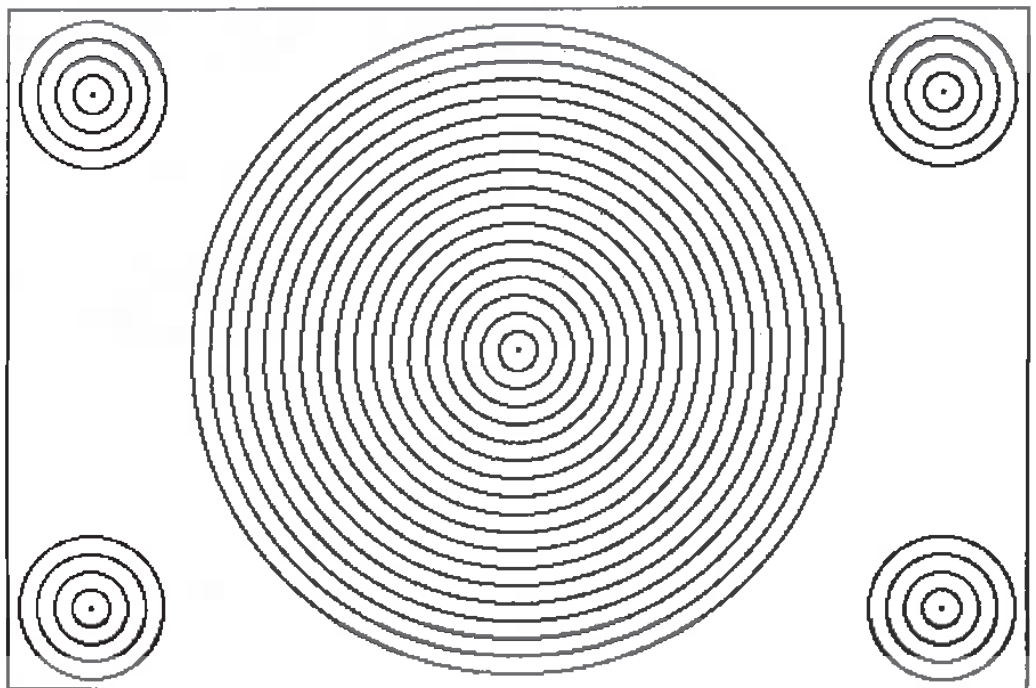

Figure 2-12 Optional Circles (512K-TPG only). Holding down the Option key while choosing Center Circles hides the menu bar and draws four additional test patterns.

Checking Screen Balance

Once the circularity has been evaluated, check the screen balance by choosing Balance Test (Command T) from the Test Patterns menu. Choosing Balance Test hides the menu bar and sets up a full-screen broadcast-style test pattern as shown in Figure 2-13. Each of the propeller sets should be well balanced. One set should not be larger or brighter than the other; both sets should be the same size; and most importantly, their fill patterns should have exactly the same intensity. The background grid should either be 1-inch or 1-centimeter square, depending on whether or not the metric system is in effect. Note your observations on the worksheet, then click anywhere or press the Return key to restore the menu bar.

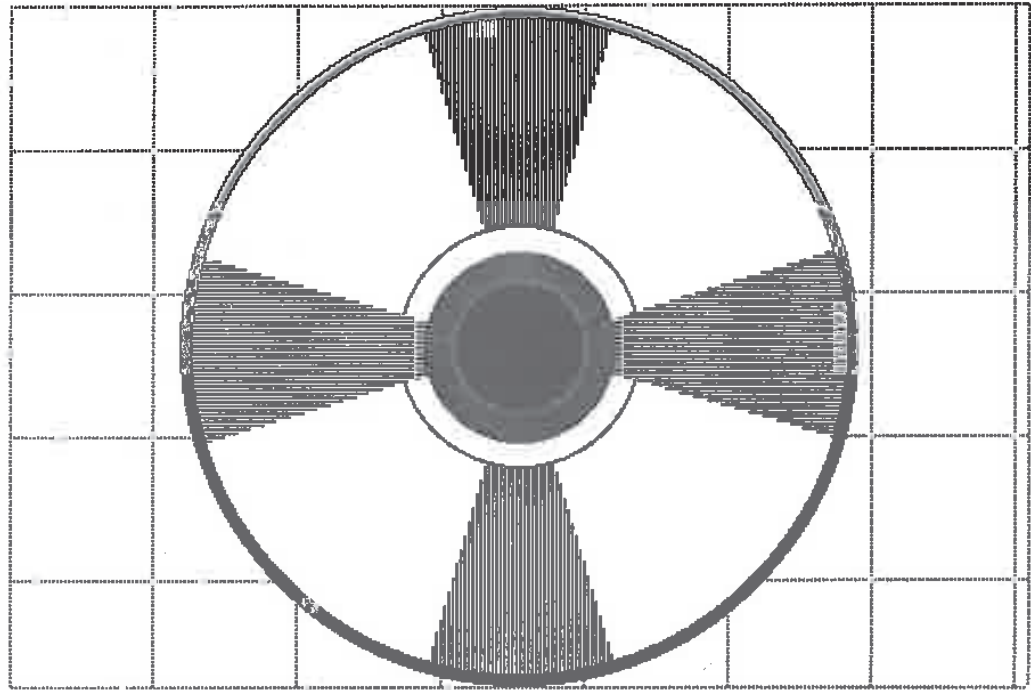

Figure 2-13 Balance Test. The propeller sets should be exactly the same size. The fill patterns should have exactly the same intensity. The grid blocks should be perfectly square.

For a full-screen balance test (512K-TPG only), hold down the Option key and rechoose Balance Test from the Test Patterns menu. This hides the menu bar and draws four additional broadcast-style test patterns as shown in Figure 2-14. The smaller patterns are designed to check balance in the corners relative to the center. All five of the test patterns should be perfectly round. The background grid remains either 1-inch or 1-centimeter square, depending on whether or not the metric system is in effect. This pattern can

tell you a great deal about the condition of a Macintosh. If one or more of the corner patterns looks strange, it's not the program! It's the set. Note your observations on the worksheet, then to restore the menu bar, click anywhere or press the Return key.

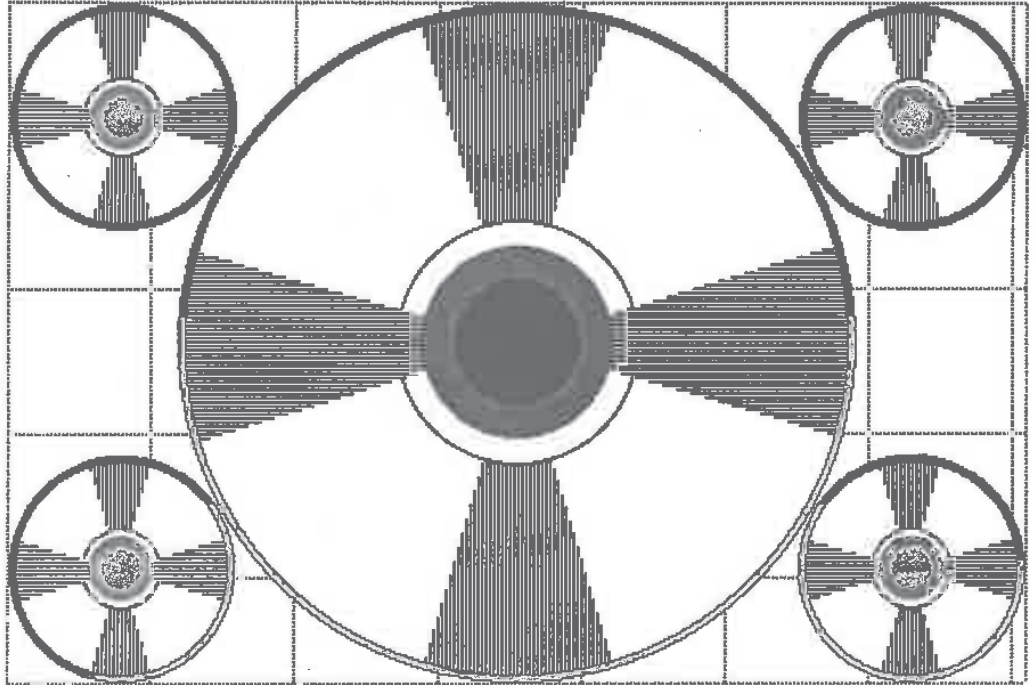

Figure 2-14 Optional Balance Test (512K-TPG only). The optional Balance Test hides the menu bar and draws four additional test patterns. This test is designed to check balance in the corners relative to the center.

Checking the Focus

Once the overall balance has been evaluated, choose Focusing Text (Command F) from the Test Patterns menu.

As shown in Figure 2-15, choosing Focusing Text (Command F) fills the screen with 9-point Monaco text. Individual characters, regardless of screen location, should be uniformly sharp and well focused. Text at the corners of the screen should be just as sharp as text in the center. The older the set is, the more likely there'll be a problem, especially if you've been operating in hot (90 degree and above) weather without a fan. Check the upper right corner of the screen very carefully. Invariably, that's where the first signs appear.

For 12-point characters, hold down the Option key while choosing Focusing Text from the Test Patterns menu. On a large monitor, 12-point

Monaco text fills in much faster than 9-point. Choose 9-point text for greater detail. Choose 12-point text for a faster fill in. Of course, you can only get 12-point Monaco text if that size is installed in your System file. If someone removed it, or if it was never installed, 9-point Monaco text will appear in either case. On very large monitors, fill in may take a few seconds. You can stop the fill in any time you like by pressing Command Period.



Figure 2-15 Focusing Text. Text at the corners should be just as sharp as the text in the center.

In order to evaluate the focus, it may be necessary to clean the screen first. If it's covered with finger prints or if it's cigarette stained, the evaluation will be invalid. A lot of what might appear to be a focus problem is actually dirt. The easiest way to clean the screen is to choose White Raster (Command Option W) from the Test Patterns menu. White Raster hides the menu bar and clears all text and graphics. Pass a damp paper towel across the screen, and any streaks or stains you leave behind will be very easy to spot.

Reversing the Video—Checking for Screen Ghosts

In certain situations, you might find it easier to work in reverse (white on black) video. For that, choose Black Raster (Command K) from the Test

Patterns menu (512K-TPG only). Black Raster inverts the screen and displays a ghost testing cursor, as shown in Figure 2-16. Dragging the cursor around shouldn't leave a trail; afterimages should barely be noticeable. This is more of a problem with Lisas and Mac XL's than it is with small Macs.

Note: To check for ghosts using 128K-TPG, choose Reverse Video from the Test Patterns menu, then choose Clear Screen from the Test Patterns menu. There's no specific ghost testing cursor in 128K-TPG, but you can still check for ghosts on 128K Macs by dragging the arrow cursor around.

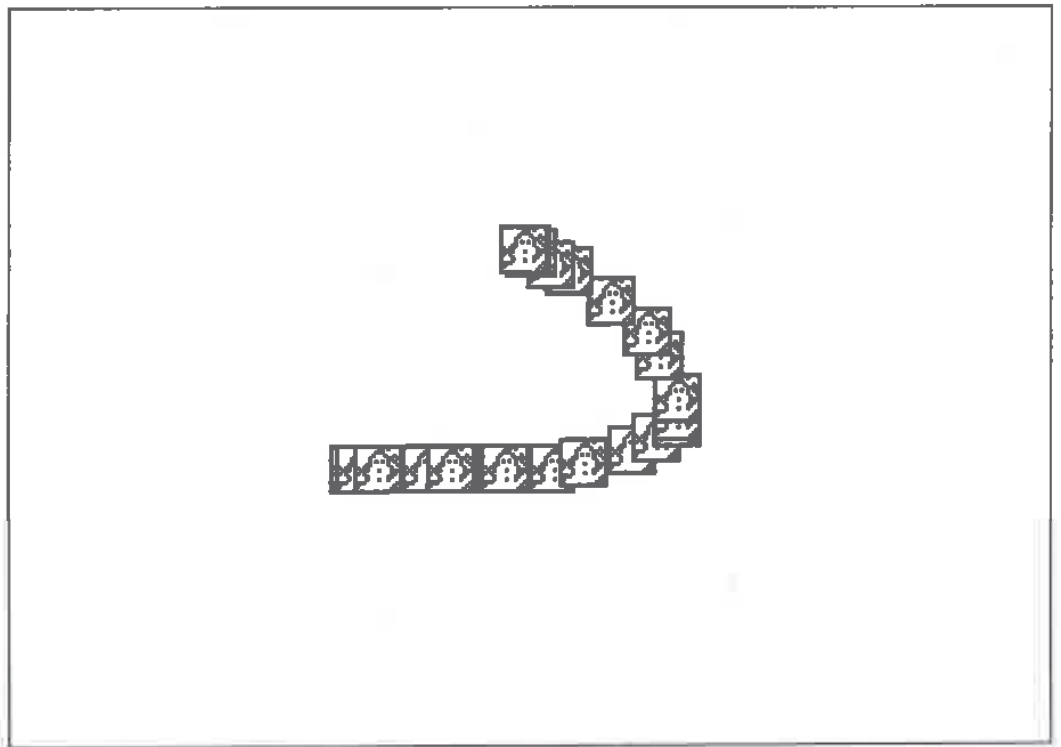

Figure 2-16 Black Raster. Dragging the cursor around shouldn't leave a trail.

To restore the menu bar, click anywhere or press the Return key. Once you select Black Raster (Command K) from the Test Patterns menu, it remains in effect until you restore normal (black on white) video by selecting White Raster (Command Option W) or Reverse Video. Most of the test patterns reverse, but the help screens never do, because printing in reverse video is not recommended. If you try, TPG will attempt to stop you. Not only does reverse video waste ribbons, but some printers overheat when printing that much black.

Advanced Techniques

By choosing *Unlisted Mac Monitors...* from the *Screen Sizes* menu and entering new dpi values, you can change the grid size. For example, on a 9-inch Mac (normally 72 × 72), entering 36 × 36 as shown in Figure 2-17 results in a double-density 1/2-inch grid, entering 18 × 18 results in a quadruple-density 1/4-inch grid, etc. Changing these values also affects the space between concentric circles. Entering 36 × 36 dpi results in 1 + 16 linearity rings, entering 18 × 18 results in 1 + 32 linearity rings, etc. If you do this, bear in mind that the calculations displayed on the T-squares will be incorrect.

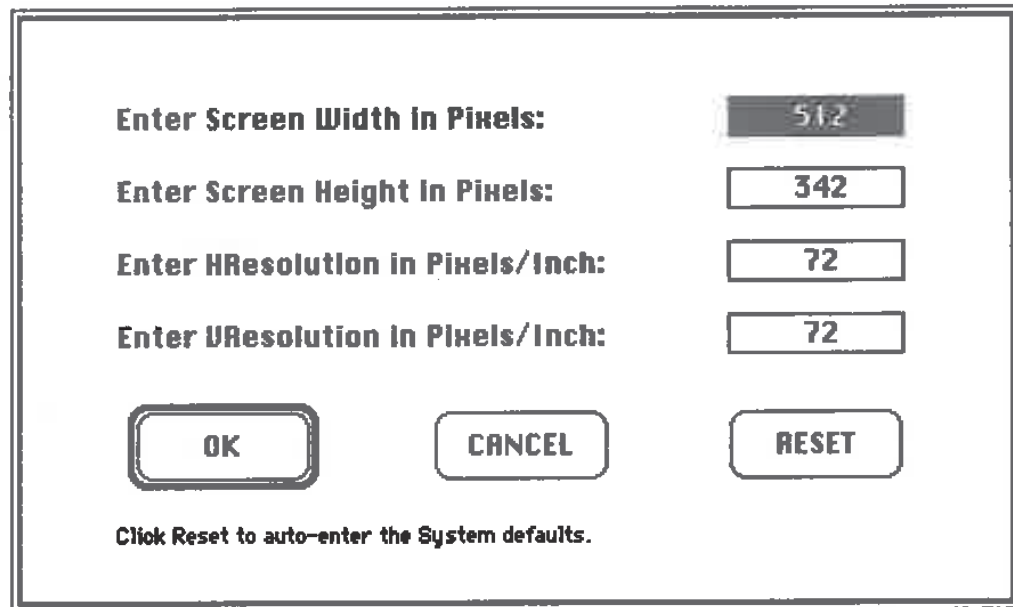

Figure 2-17 *Unlisted Mac Monitors...* dialog box. By choosing *Unlisted Mac Monitors...* from the *Screen Sizes* menu and entering new dpi values, you can change the grid size.

Once you change the dpi values, you can restore the toolbox defaults at any time by clicking the *Reset* button. If you click the *Reset* button and get a beep, it means the current values already are the toolbox defaults. The beep indicates there was nothing to *Reset*.

Aspect Ratio

For use with disproportional monitors (sets displaying more dpi in one direction than in the other), all four linearity tests consider aspect ratio. The other eight tests do not. For example, the original monitor built into an unmodified Lisa (or a Mac XL) displays 90 dots horizontally by 60 lines

be displayed. That saves time, especially with unlisted monitors, because you won't have to enter the odd values again. For use with the 128K to Mac SE, the choice to make is 9-inch Std. Macintosh. You should make a choice now, because if there is no TPG.Prefs... file in the System folder, 512K-TPG always displays General Instructions on startup, on the assumption that it's the first time you've run the program.

Checking the Voltage

Just as a person's physical appearance tells you a lot about his health, the screen's appearance tells you a lot about a Macintosh. But it can't tell everything. A person (or a screen) might look fine, but when he's low on energy, the least bit of strenuous exercise and he runs out of steam. In the next test we're going to check the Mac's energy supply (power-supply voltage). For that you need a multimeter, some tape, or some plastic tubing, and two steel (unpainted) paper clips.

The critical operating voltages (128K to Mac Plus) are +5 volts, -5 volts, +12 volts, and -12 volts. As shown in Figure 2-19, you can measure three of these supplies without taking the Macintosh apart by probing the disk drive connector. It's not possible to do this with an external drive connected, so if necessary, choose Quit (Command Q) from the File menu, then shut down, switch off the power, and disconnect the drive. When you turn the Mac back on again, it won't be necessary to reboot. Just switching on the power will restore voltage. Table 2-1 shows what to expect.

If you decide not to use tubing, at least wrap tape around the exposed centers of the paper clips. Be extremely careful not to touch (short) the ends together, which may damage components on the power supply board. Instead of a simple adjustment, you'll need a component level repair. That can be expensive and time-consuming. At the very least, TAPE THE CLIPS.

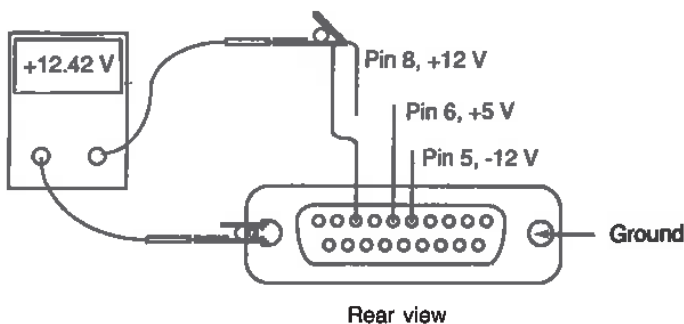

Figure 2-19 Measuring voltages at the disk drive connector.

vertically. Because 90 dots/60 lines = distorted images, 1.5 times taller than on a standard Mac (where 72 dots/72 lines = 1), proportional images are distorted by a factor of 150%. That distortion factor is known as the aspect ratio. In Test Pattern Generator, all four linearity tests compensate for aspect ratio. Entering 90 by 60 on an unmodified Lisa (running TPG) does return a true 1-inch grid and also returns reasonably round $\frac{1}{8}$ -inch circles. As a result, you can rely on the linearity tests to set up even the most unusual external monitors and still rely on the balance tests (which do not compensate for disproportional screen values) to evaluate overall performance with graphics software.

Setting Preferences

Choosing Set Startup... from the Special menu (512K-TPG only) allows you to configure Test Pattern Generator for your personal needs. As shown in Figure 2-18, you can have the program default to any of the listed monitors or even have it default to a custom size.

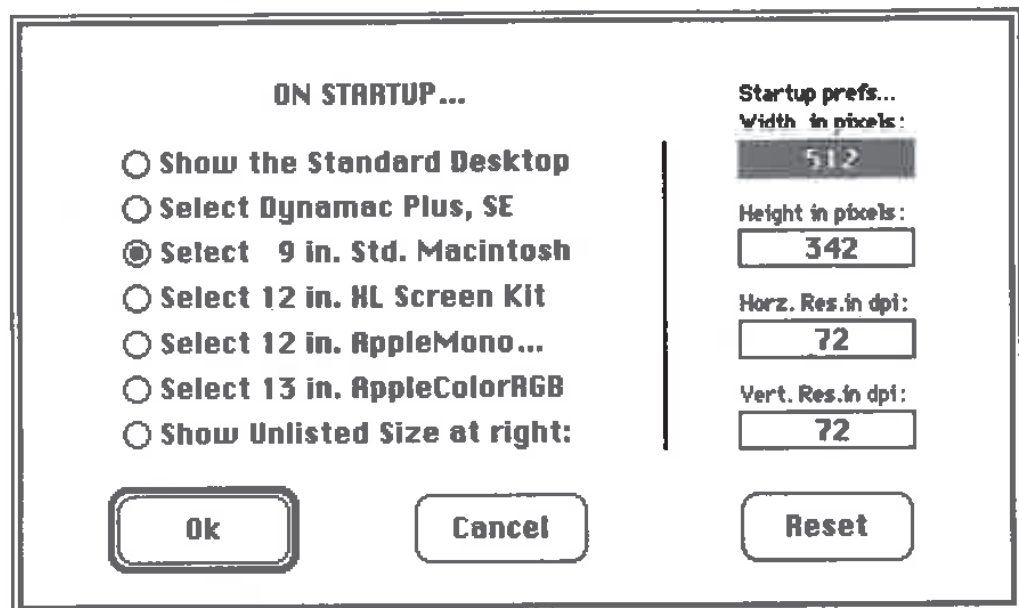

Figure 2-18 Set Startup... dialog box (512K-TPG only). Choosing Set Startup... from the Special menu allows you to configure Test Pattern Generator for your personal needs.

For a standard size, click on the appropriate radio button. For a custom size, enter new values in the edit fields, then click the Show Unlisted Size at Right... button. Clicking OK instantly displays T-squares for the selected size (standard or custom), and creates a preferences file in the System folder. From now on, every time you start the program, the preferred size T-squares will

Table 2-1. Voltage Specifications—128K to Mac Plus Power Supply

Supply	Specification	Typical	Desired
+5 V	+4.85 V to +5.15 V	+4.93 V	+5.0 V
+12 V	+11.9 V to +12.80 V	+12.4 V	+12.45 V
-5 V	-5.25 V to -4.75 V	-5.1 V	-5.0 V
-12 V	-13.00 V to -11.30 V	-12.3 V	-12.15 V

To check the +5-V and +12-V supplies, set your multimeter to read DC volts and clip the black probe to ground. As shown in the diagram, ground is pin 1 or any bare metal on the connector strip. The metal nuts on either side of the DB-19 connector are good places to clip onto. To check the +5-V supply, touch the red probe to pin 6. To check the +12-V supply, touch the red probe to pin 8. To check the -12-V supply unclip the black probe, attach the red probe to ground, and touch the black probe to pin 5. Note the results on your worksheet.

An easier way to check the +5-V supply only is to make the adapter shown in Figure 2-20.

To make this adapter, you'll need a DB-9M connector, a D-9 shell, 18 inches each of blue and violet 20-gauge wire, and two plugs (generally banana), one red, one black to fit your multimeter. You could substitute red and black wire, but blue and violet match the color code of the 128K to Mac Plus internal power supply harness. For consistency, try to use the same colors.

The specifications call for 4.85 V to 5.20 V. More often than not, you'll find the voltage is on the low side. If it's any less than 4.95 V, you've probably got a severely shrunken display and System errors are probably an everyday occurrence.

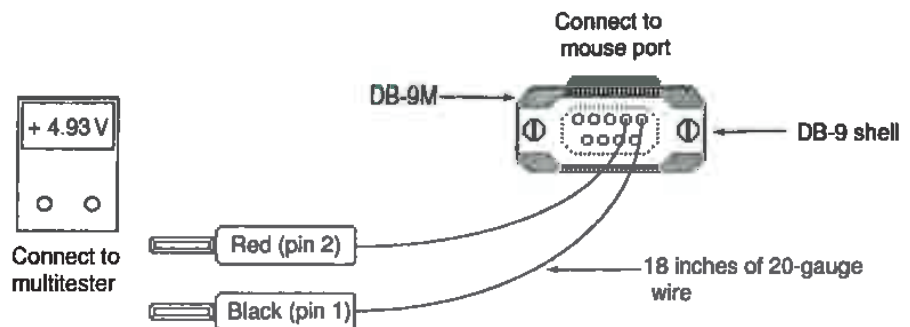

Figure 2-20 Voltage checking adapter for 128K to Mac Plus, Lisas, and Mac XL's. Not for Mac SE.

Summary

At this point, you should have a good idea of exactly what's wrong with your Macintosh. If it's an older machine, particularly an older machine with a memory upgrade, you've probably found that it's got low voltage and a shrunken display. If you never installed a fan, it may be way out of focus. In the next chapter, we're going to fix all of that by tuning the power supply with a set of plastic alignment tools. Don't be discouraged. With TPG and a multimeter, it's easy. Regardless of how bad the screen looks now, you're not going to believe the difference!

CHAPTER



Adjustments

This chapter describes the 128K to Macintosh SE, TPG tune-up procedure. The instructions assume that you've got a working set, that you've made a TPG/System disk, and that you know how to take the back off the set. If necessary, please review Chapters 1 and 2 for specific details. If you're planning to work on a Macintosh SE, there are minor hardware differences (which aren't described here) that you need to know about. Please read the first section of Chapter 14, "Macintosh SE Repair Secrets," before proceeding.

Inside Macintosh

As shown in Figure 3-1, there are only two circuit boards inside the Macintosh (128K to Mac Plus). The analog board stands vertically along the right side of the computer (as seen from the back), and the logic board is mounted horizontally on rails underneath the disk drive.

The TPG tune-up procedure pertains strictly to the analog board. The Macintosh analog board is somewhat unusual in that it combines a standard switching power supply with high-voltage CRT circuitry. Most other computers (including Lisas, XL's, SE's and Mac II's) have separate boards for these functions. Usually the boards are inside metal enclosures, making them difficult to get at. Often, the critical adjustments are unidentified. On the Macintosh, all of the adjustments are clearly identified, and the fact that everything is on one board, right out in the open, makes it that much easier to work on.

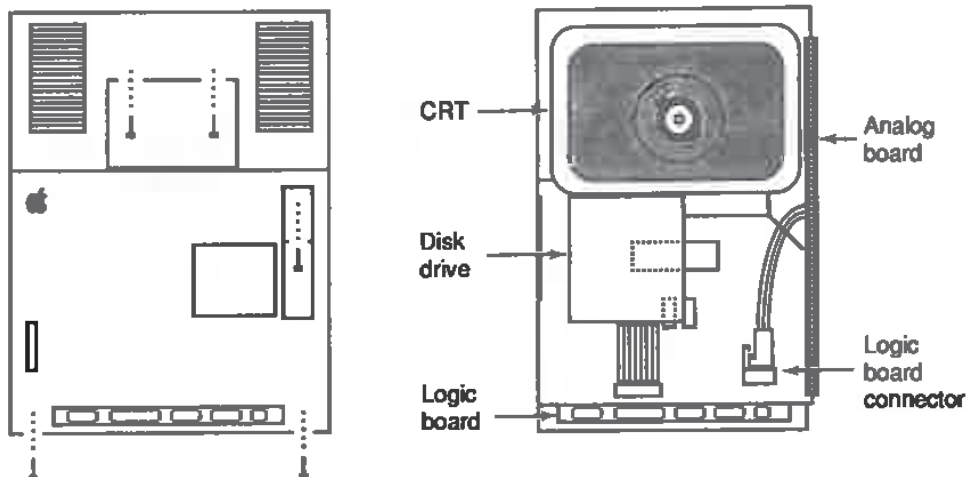

Figure 3-1 Inside Macintosh. The analog board stands vertically along the right side of the computer (as seen from the back), and the logic board is mounted horizontally on rails underneath the disk drive.

As shown in Figure 3-2, all sets have a vinyl jacket covering the analog board. This jacket provides a handy tune-up reference, plus it insulates you from exposed solder connections. All work is done from this side of the board. In the event that the vinyl jacket is missing, make doubly certain that you remove all rings, watches, and other jewelry before beginning this procedure.

To help identify the adjustments, Test Pattern Generator also contains a backup drawing as shown in Figure 3-3. To view the drawing on-line, simply choose Mac Video Alignment from the Reference menu. To print the drawing for posting over the workbench, make sure there's a printer connected, turn it on, and choose Print... from the File menu.

Definitions

All of the adjustments on the analog board affect the display. As illustrated in Figure 3-4, the word "display" refers to the illuminated area of the screen. That which is displayed on the screen is the display. The word "screen" refers to the entire face of the CRT. Only the center portion is used for the display. The edges are normally blanked out (they are not displayed). The acronym "CRT" refers to the Cathode Ray Tube, the whole thing—the front, the back, the neck, the anode, the cathode, the socket pins, and so on.

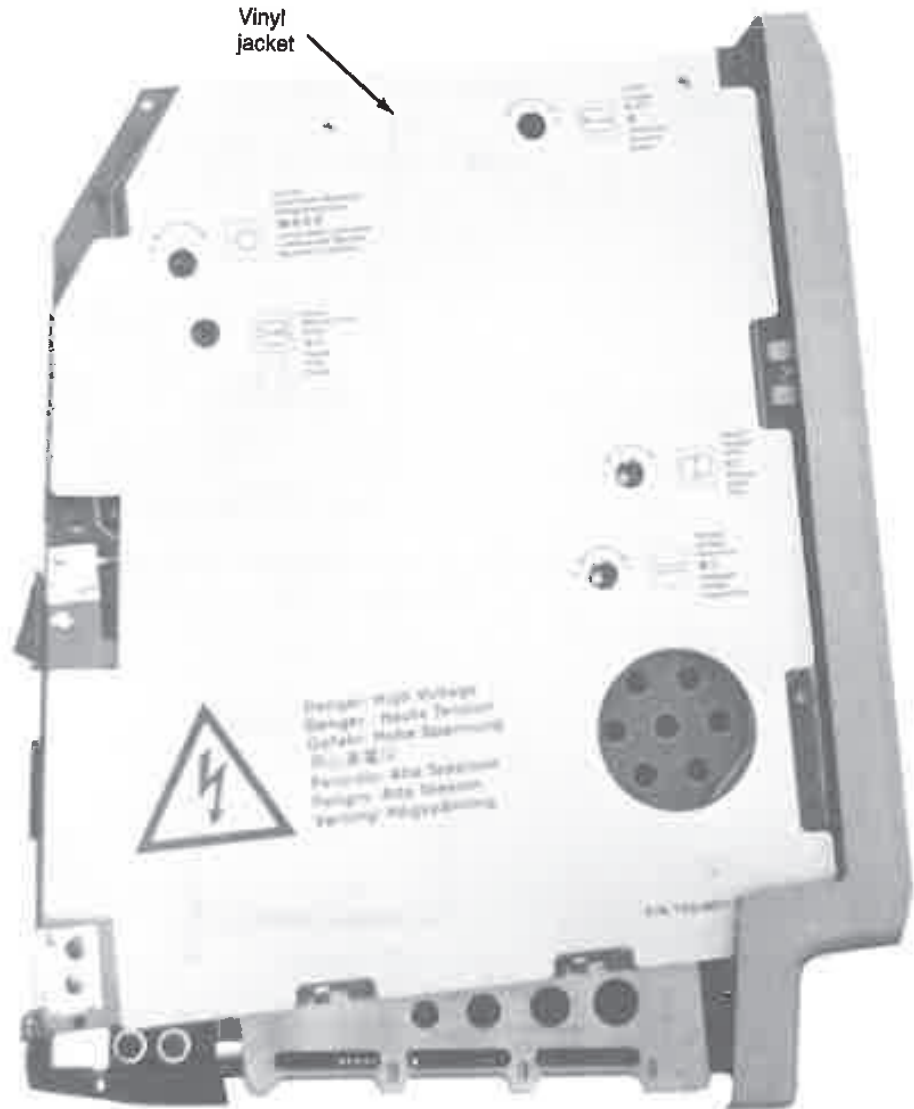

Figure 3-2 Analog board. All sets have a vinyl jacket covering the analog board. This jacket provides a handy tune-up reference, plus it insulates you from exposed solder connections.

When the screen is out of adjustment, the display is said to be shrunken (or stretched, though that's not likely). For clarity, the screen itself is made of glass—it never shrinks or stretches. Understanding the differences between these terms now will help prevent misunderstandings later. It will also give you a tremendous technical advantage. A lot of people don't understand the difference, hence they get frustrated, they can't follow instructions, and they can't communicate with professionals. If you ever forget the definition of a term, don't get frustrated! Flip to the Glossary in Appendix A and look it up.

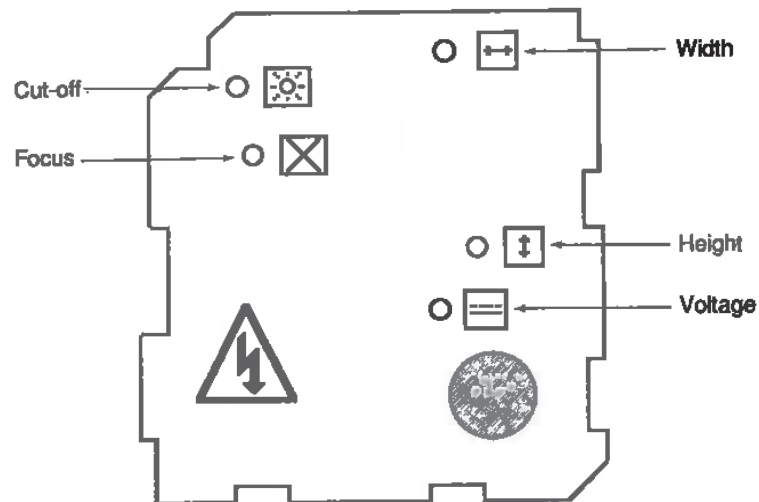

Figure 3-3 Mac Video Alignment. To view this backup drawing on-line, choose Mac Video Alignment from the Reference menu.

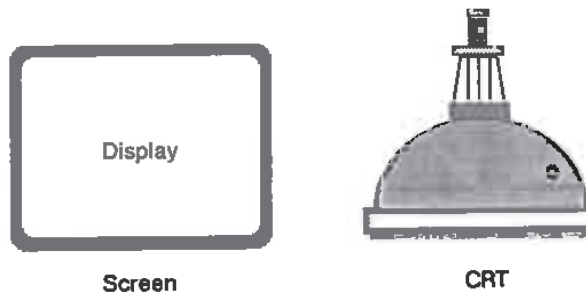

Figure 3-4 Parts of the CRT. The CRT is the whole thing. The screen is the front. The display is what's shown on the screen.

Tune-up Procedure

Not counting disassembly and reassembly, the entire tune-up procedure involves seven simple steps:

1. Adjust the voltage.
2. Adjust the cut-off.
3. Adjust the width.
4. Adjust the height.
5. Synchronize settings.
6. Center the results.
7. Adjust the focus.

The order of these steps is critical. When you do them out of sequence, each step cancels the other and you don't get anywhere! Plan on spending about an hour to work through this material for the first time. Once you've mastered the technique, subsequent tune-ups will take only 10 to 15 minutes.

Adjusting the +5-V Supply

Begin by turning on your multimeter and setting it to read DC volts. Digital meters generally stabilize within seconds, but older electronic meters may need a minute or so to warm up. Nothing is more frustrating than taking a reading, only to find that a few minutes later the meter has changed! Most meters run on batteries and sometimes, just like a flashlight, that battery has a little more pep on power up.

While you're waiting for the meter to stabilize, confirm that the computer's power cord is physically disconnected from the wall outlet. Then, locate the multicolored wiring harness that runs from the analog board to the logic board. As illustrated in Figure 3-5, insert the multimeter's red probe into socket 6, alongside the blue wire in the logic board connector. Since socket 2 is empty, be sure to count sockets, not wires. Otherwise, you may end up with the probe in socket 7! For future reference, try to remember that socket 6 is exactly in the middle of the 11-pin connector. Trick sockets and blue colored wires are quickly forgotten. Middle position is easy to remember. So where do you want to put it? Right down the middle.

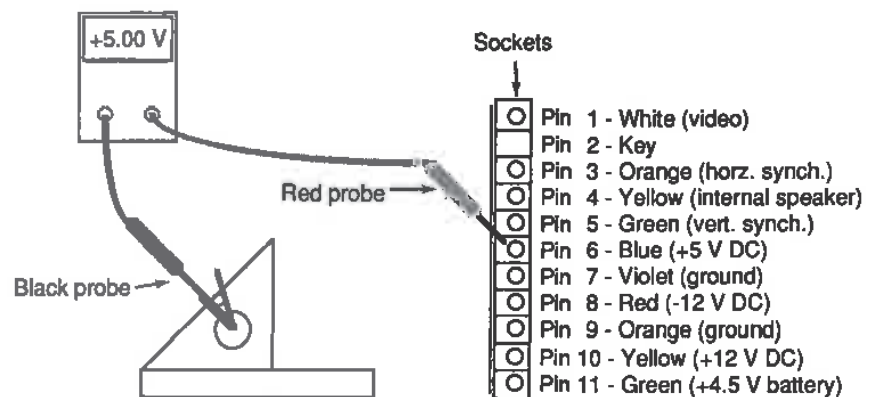

Figure 3-5 Test setup. Insert the multimeter's red probe into socket 6, alongside the blue wire in the logic board connector. Clip the black probe to the chassis.

Note that the red probe can be inserted into either side of the socket, but one side is a very tight fit, while the other side is a perfect fit. If you're having trouble getting the probe to stay put, try the opposite side of the socket. Next, clip the multimeter's black probe to the Macintosh chassis. The word "chassis" refers to the metal frame of the computer. When the test setup is nice and

secure, when you can wiggle things without the probes falling out, check the meter to be sure it's set to read DC volts, reconnect the power cord, and make a mental note of the exposed solder connections next to the power switch.

Being careful not to touch those connections, switch on the Macintosh. Observe the multitester. If it reads 0.00 V or just a few millivolts, assuming the Macintosh "bonged" and powered-up normally, the red probe is probably loose. Push it a little further into socket 6. The meter should now indicate +5.00 V to 5.01 V. If it reads less than +5.00 V or greater than +5.01 V, locate the voltage potentiometer which is just above the speaker, on the lower right quadrant of the analog board. Be sure to read the labels on the vinyl jacket. The correct spot is marked "Voltage" in seven languages! From the vinyl-jacketed side of the board, not from inside the computer, insert the screwdriver end of a plastic TV alignment tool and carefully turn the voltage pot. (Pot is short for potentiometer.) On an analog meter (one with a needle pointer and a scale) set the voltage to +5.00 V. On a digital meter (one with a numerical readout), adjust for 5.00 V to 5.01 V. The last digit will usually fluctuate on a numerical readout. That's normal.

When setting the voltage, or any of the other adjustments in this chapter, turn the screws very carefully. The trimmer pots are delicate. They're not designed to go around and around. They're not designed to be tightened down. Grip the tool lightly. Take it easy. A little trim generally goes a long way.

Pass or Fail? The actual range of the voltage adjustment is 4.60 V to 5.40 V. If you turn the screw all the way up and the meter still doesn't read 5.00 V, you may be turning it backwards. Try turning it the other way. If that doesn't work, it means you've got a component level problem. Further tune-up adjustments will be pointless. Skip to Chapter 4 to learn what's wrong. Fix the problem. Then, come back here for additional information.

Assuming you can adjust it for 5.00 V to 5.01 V, the +5-V supply passes. But what grade do we give it? "A"? "B"? "C"? "D"? You can *really* test the +5-V supply by turning the voltage pot all the way up. A Grade-A supply will hit 5.35 V to 5.40 V and trigger the crowbar circuit. To prevent overvoltage damage, the crowbar circuit bong (shuts down) the computer and makes a protective flup, flup, flup noise. It's not good for an overvoltage condition to go on for very long, so turn the trimmer screw very carefully and watch the meter. Some supplies will crowbar at 5.35 V. Others make it all the way to 5.40 V before triggering the crowbar. Either way, as soon as you see 5.40 V or hear the bong, flup, flup, flup noise, back off the trimmer. Don't let the overvoltage situation continue! Readjust for 5.0 V to 5.01 V, then grade the test results according to Table 3-1.

Table 3-1 Power Supply Output Ratings

Maximum Voltage	Grade	Upgrade Potential
5.30 V to 5.40 V	A	No holds barred. Add anything you want.
5.20 V to 5.29 V	B	Moderate memory upgrades OK.
5.10 V to 5.19 V	C	Light loads OK, but take it easy!
5.00 V to 5.09 V	D	Should not be loaded but OK to use.
4.65 V to 4.99 V	F	Should not be used. Needs repairs!

A supply that hits 5.30 V to 5.40 V is a great candidate for big memory upgrades. 5.30 V to 5.40 V means the supply has lots of reserve power. You should be able to adjust *everything* perfectly, no matter how much RAM (random access memory) you add. A weak supply might only adjust to 5.20 V. It's still serviceable, and you'll probably be able to work wonders with the screen, but if you add extra memory, take it easy. Really bad supplies might not get past 4.80 V. These have no reserve power. You'll never be able to adjust the screen until you get it fixed.

So if a 5.00-V setting is good, is a 5.10-V or a 5.20-V setting even better? No! The final setting should always be 5.00 V. Better supplies will adjust to 5.00 V no matter what load you put on them; weaker sets won't. Also, some sets (especially older sets) draw less current when they're cool. If you set the power supply to more than 5.00 V now, when the load is high, that power supply might suddenly develop a full 5.35 V tomorrow morning, when the load is less. Instead of powering up, all you're going to hear is the flup, flup, flup noise, and if you don't power down immediately, you'll be faced with a component level repair. Even if you do power down immediately, you'll still have to take the set apart again, and you'll have to repeat the entire adjustment procedure.

To keep that from happening, some analog board repair services adjust to 4.95 V as a matter of course. Since the loose board still has to be reinstalled in an unknown computer, they want to be on the safe side. From my own experience, I've determined that the heat/cool discrepancy (when it happens) is approximately .35 V. At 4.95 V, the most the repaired supply might develop when the customer reinstalls it is 5.30 V ($4.95 + .35 = 5.30$) which is .05 V below the crowbar level. If it's your own set, you've got more control over the situation. The analog board is already matched up with a logic board. A perfect 5.00 V adjustment (no more, no less) is exactly what you want.

Adjusting the Cut-off

Once you got the voltage adjusted, face the front of the computer and locate the brightness control knob as shown in Figure 3-6. The brightness knob is located under the Apple logo, to the left of the disk drive. Turn the brightness knob all the way up. Now locate the cut-off adjustment on the upper left

quadrant of the analog board. Read the labels. It's also marked in seven languages! From the vinyl-jacketed side of the board, insert the screwdriver end of a plastic TV alignment tool into the opening, and turn the cut-off control all the way up. The function of the cut-off control is to blank out the areas of the screen which lie outside of the display area. It should not be blanking inside the display area. Remember that the display area is defined as the illuminated part of the screen. At the maximum setting, the cut-off control *doesn't* blank the outside areas, scan lines appear, and the black borders to the left and right of the display turn gray. The under-blanked screen should look like Figure 3-7.

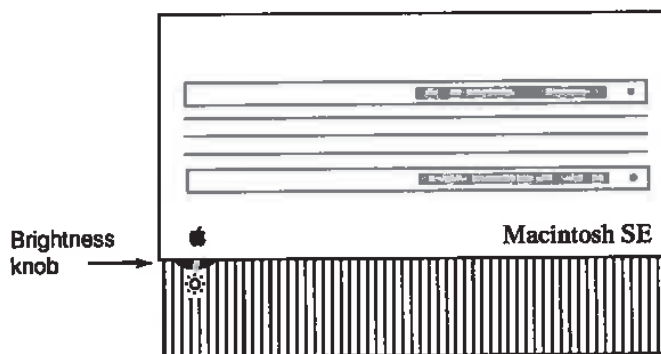

Figure 3-6 The brightness knob is located under the Apple logo, to the left of the disk drive.

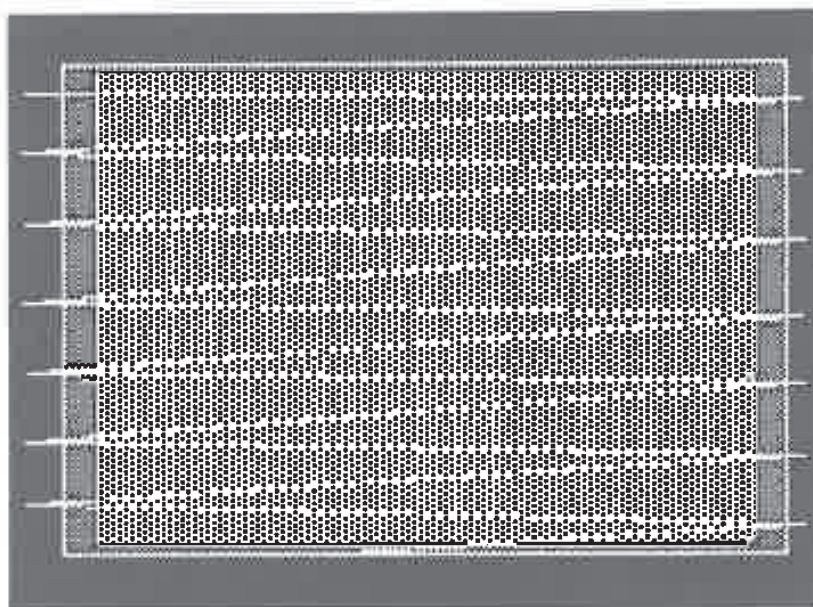

Figure 3-7 Cut-off adjustment. With the brightness and the cut-off both turned to maximum, the screen should look like this.

Now turn the cut-off down, until the scan lines *just* disappear. Look at the screen carefully to make sure they're completely gone. Check the black borders to make sure they're distinctly black. There shouldn't be any hint of gray. When both of those conditions are met, the cut-off setting is correct. It's neither over-blanking nor under-blanking. Now, back off the front panel brightness knob for comfortable viewing. How do you define "comfortable" viewing? If you're squinting, you're uncomfortable. Concentrate on your face muscles and stop when they relax.

The "comfortable" setting varies with room light. Generally, the darker the room, the lower the brightness control should be. The brighter the room, the higher the brightness control should be. On a better TV set, you only have to adjust the brightness once. In full sun light, an electric eye turns the brightness up. At night, the electric eye turns the brightness down. If the electric eye is working right, the comfortable setting is maintained automatically. Since the Macintosh doesn't have an electric eye, you have to maintain the comfort setting. Unless the room light never varies, make it a point to adjust the brightness knob each and every time you use the computer. Your eyes will thank you!

Adjusting the Width

With the voltage and the cut-off set properly, the next step is to adjust the width. Locate the width control on the upper right quadrant of the analog board. Remember to read the labels! From the vinyl-jacketed side of the board, insert the rounded-end of a plastic $15/32$ -inch TV alignment tool into the opening and see if the dark-gray center of the coil turns. The coil form is clear, so you can peek over the top of the analog board and watch. The center "slug" should turn easily, but sometimes, especially in an older set that's been operating without benefit of a fan, the slug freezes to the coil form. (Actually, it's the coil form that melts around the slug.) Instead of turning the slug, the thin, plastic tool-shaft twists. If that happens, withdraw the tool and try the other end. Both ends should have the same size tip, but the end you naturally tend to grip has a thicker shaft and it develops more torque. Generally, reversing the tool is all it takes.

If the thick end doesn't work, you can free the slug with a $15/32$ -inch metal hex tool. Many people give up when the plastic alignment tool twists, only to find that replacement width coils are very difficult to find. Cheap assortments of hex tools are very easy to find. Shut down, find a hex tool to fit the slug, insert it all the way in, and apply gentle pressure until the slug begins to turn. Once it begins to move, gently turn the slug all the way in, then gently turn it all the way out to cut new threads in the coil form. When the slug turns freely in both directions, return it to a middle position. Withdraw the hex tool

and power up again. Remember, using a metal hex tool is only a contingency procedure. In most cases, the slug will turn freely regardless of which end of the plastic tool you insert.

Whenever you use a metal hex tool to free the width coil slug, be sure to shut down and disconnect the power cord, first. Otherwise, you may damage the analog board and you could get an electrical shock!

Once you've established that the coil is adjustable, boot with a TPG/System disk and make your way to the T-squares screen. Tear out the *Macintosh Repair & Upgrade Secrets* bookmark (if you haven't already), cut it to size, and hold it up to the screen as shown in Figure 3-8. Generally the 7.11-inch ruler on the bookmark is going to be wider than the 7.11-inch T-square. Turn the width control until they're both exactly the same size.

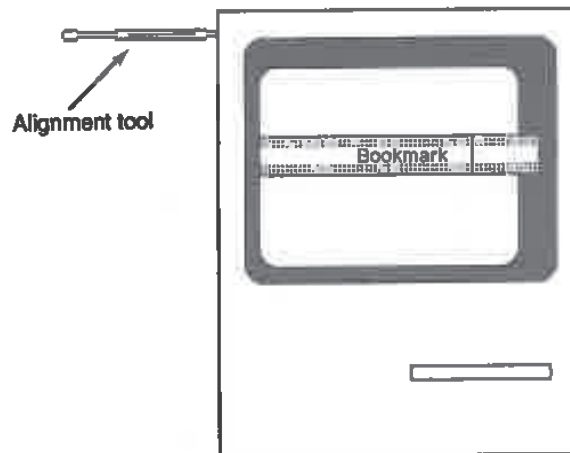

Figure 3-8 Width adjustment. Hold the bookmark up to the screen with your right hand. Adjust the width control with your left hand.

Adjusting the Height

Next, locate the height control which is just above the voltage control on the right side of the analog board. Turn the bookmark around as shown in Figure 3-9. From the vinyl-jacketed side of the board, insert the screwdriver end of a plastic TV alignment tool into the opening, and adjust the height control until the display and the bookmark/ruler are exactly the same size.

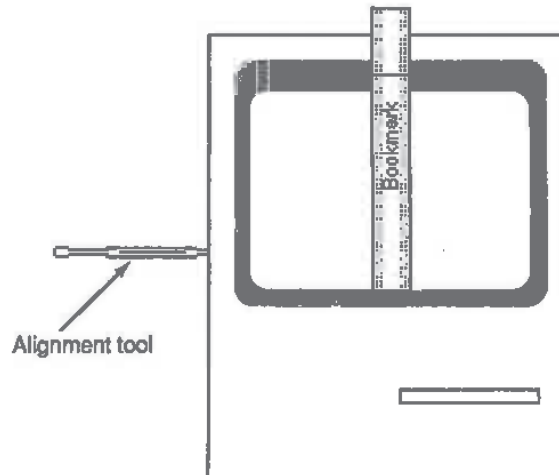

Figure 3-9 Height adjustment. Turn the bookmark around to adjust the height.

Synchronizing the Settings

Now it's time to synchronize the height, the width, and the voltage. If the screen was way out of adjustment, restoring the full height and width has probably dragged the power supply down. Check the multimeter to see if it's still reading 4.99 V to 5.01 V. If necessary, readjust the voltage control. Now check the height and width against the bookmark. Jacking the voltage back up may have expanded them even further. If necessary cut back the height and width to 4.75 inches and 7.11 inches respectively. Repeat this sequence (as necessary) until you get all three adjustments right on the mark. Generally, one tweak is all it takes.

Centering the Display

When the height, the width, and the voltage are synchronized, choose *Center Cross* from the *Test Patterns* menu. Cut the diagonal with a folded piece of paper as shown in Figure 3-10. Does the diagonal cut the intersection of the cross? Most likely, the display is off-center to the left. If it's only slightly off, leave it alone. Getting the display perfectly centered is difficult. On the other hand, if the left side of the display is completely hidden behind the cabinet or if there's no border at all along the left side, the purity tabs will have to be adjusted.

Without touching anything, locate the purity tabs on the neck of the CRT as indicated in Figure 3-11. If these tabs have never been moved before, they'll factory sealed with a dab of paint. In order to adjust the tabs, you'll have to break the seal. Check, without touching, to see if the paint is cracked. If it is cracked, you're all set. If not, shut down, remove the power cord, put on safety goggles and use two hands to gently push the tabs in opposite

directions. It doesn't take much pressure to crack a tiny glob of paint, and the neck of the picture tube is fragile, so be careful!

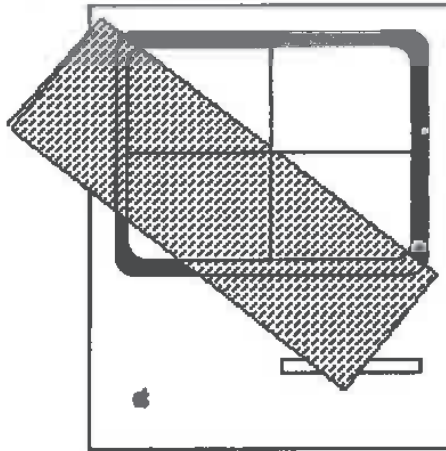

Figure 3-10 Centering check. Cut the diagonal with a folded piece of paper.

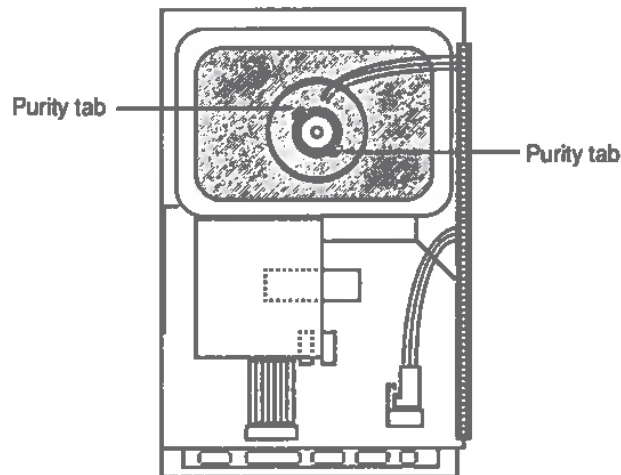

Figure 3-11 The purity tabs are on the neck of the CRT.

Now, why should you power down to do this? Aren't you just going to put your hands back in there to adjust the tabs? No, you're not! Once the seal is broken, you'll only have to use one hand. In general, you never want both hands inside a live TV set. That makes it too easy to get one hand in contact with high voltage and the other hand in contact with ground. If you get "bit" you want the shock across your fingers, not across your chest. Power down, disconnect the power cord, wear goggles, and break the seal safely. Don't take chances with electricity!

Once the seal is broken, power back up again and reestablish the center cross. The tabs move the display diagonally. If the display is off to the left, you'll have to move it up and to the right, then down to the right in order to center it. In other words, you've got to zigzag the display into the center. As shown in Figure 3-12, remove all rings, and be sure to use only one hand. Adjust the tabs one at a time. If it takes you more than 10 seconds to center the screen, you're doing something wrong.

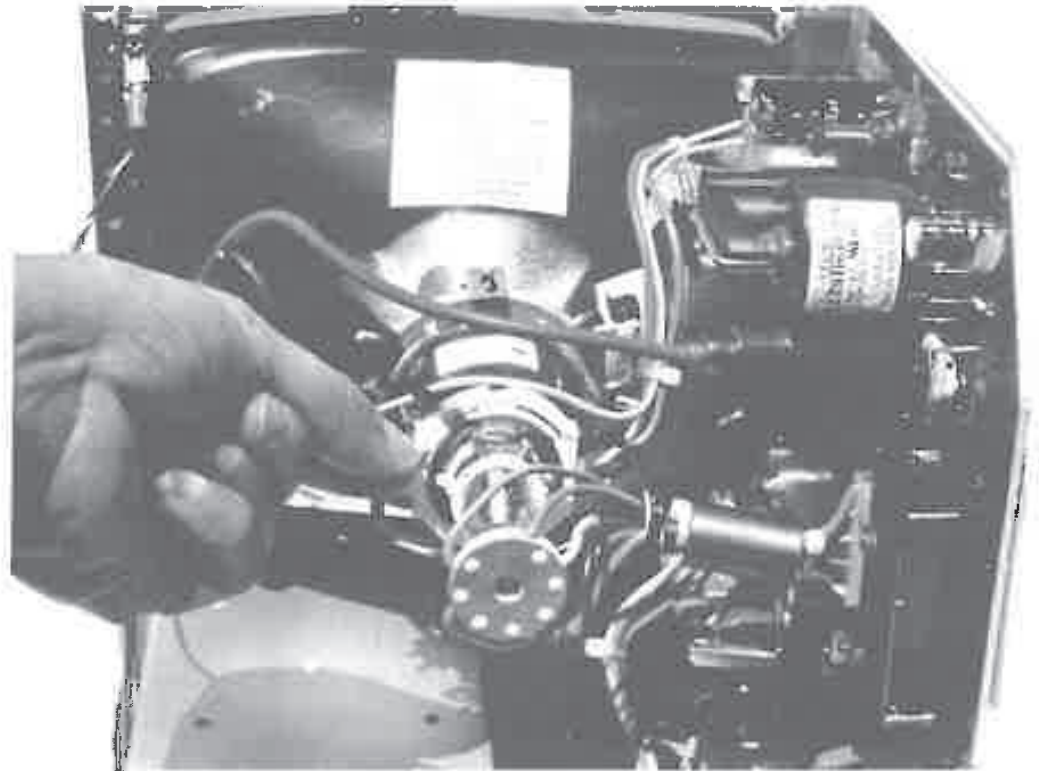

Figure 3-12 Purity tab adjustment. Remove all rings, and be sure to use only one hand. If it takes you more than 10 seconds to center the screen, you're doing something wrong.

Adjust the Focus

When the display is perfectly centered, it's time to set the focus. Begin by choosing Focusing Text from the Test Patterns menu. The screen should fill with 9-point Monaco text. Locate the Focus control on the upper left quadrant of the analog board. Remember to read the labels. From the vinyl-jacketed side of the board, insert the screwdriver end of a plastic TV alignment tool into the control, and carefully turn it from one extreme to the other. The screen should go in and out of focus as you turn the control. If nothing at all happens, or if the screen is continuously out of focus, it means you've got a component

level problem. Skip to Chapter 4 to learn what's wrong. Fix the problem. Then, come back here to finish up.

When you've established that the control is adjustable, check the corners relative to the center as you gently turn the control. Turn it a little at a time, stop frequently, and study the screen. At one point, the upper right corner will be very sharp, but the center will be fuzzy. At another point, the center will be very sharp, but the corners will be fuzzy. Somewhere between those two points, you have to decide on a happy medium. Remember that the screen has to be spotless in order to do this. Clean the screen with a damp paper towel (if necessary), work slowly, and stop often. If the screen is stained or if you whip the focus control back and forth, you'll never accomplish anything.

Once you've focused the screen, bear in mind that the next set you work on will be completely different. Sometimes a middle setting is best. Sometimes an extreme setting is best. With the possible exception of brand new sets fresh from the assembly line, no two sets have the exact same focusing characteristics.

Balance Test

To check your work, choose Balance Test from the Test Patterns menu. The full-screen display should measure 7.11 inches by 4.75 inches. The bull's-eye pattern should be nice and round. Each of the grid blocks in the background should be perfectly square. The propellers should be proportional. Use the bookmark to measure the diameter of the center circle. Is it the same everywhere? Are the grid blocks on the right side of the screen exactly the same size as the blocks on the left side? Now, hold down the Option key and rechoose Balance Test from the Test Patterns menu. (Note: Optional tests are not available on 128K-TPG.) How do the corner circles look? Try turning the front panel brightness control all the way up. (The brightness control is on the front of the computer, under the Apple logo, to the left of the disk drive.) At maximum brightness, the display should bloom a little, but it shouldn't buckle. The grid lines on the right side of the screen shouldn't twist. If everything still looks terrific, just overly bright, return the front panel brightness control to the comfort setting (the setting where your face muscles relax) and stop right there. Congratulate yourself, you've now got a perfectly adjusted set.

Even if you have an older set that buckles and blooms, it will probably be OK. The display is the right size, now, and when you back down the brightness control, it should look much better than it has for a long time. Buckling and blooming are an indication of weak components. Weak components still have life in them, perhaps years of life in them, but like older ball players, they're no longer capable of maximum performance.

In the next chapter you'll learn how to identify weak parts. By replacing them with new components, you can easily restore tip-top operating condition.

CHAPTER

4

Power Supply Problems

When the computer (128K to Mac Plus) fails to respond to the tune-up procedure (covered in the previous chapter), it usually means you've got problems in one or more of the following areas:



Problem Area	Symptom	Solution
1. +5.00 V supply	Low voltage Unstable voltage Unstable voltage	1. Replace zener diodes 2. Check connector pins 3. Check power supply cable
2. Focus control	Doesn't work Intermittent Intermittent	1. Replace open resistors 2. Check CRT socket cable 3. Check CRT socket pins
3. Brightness control	Buckles/blooms	1. Replace leaky capacitors

You don't need a degree in electrical engineering to work on these areas. It's not even necessary to troubleshoot the board. With millions of Macs in the field, we know which parts fail. The discovery work has *already* been done—thousands of times! With the repair secrets about to be revealed, you can go right to the heart of the matter, each and every time.

Which Analog Board?

There are two versions of the 128K to Mac Plus analog board. The U.S. version, shown in Figure 4-1, has a 120-V power supply. The International version, shown in Figure 4-2, has a convertible 120/240-V power supply.

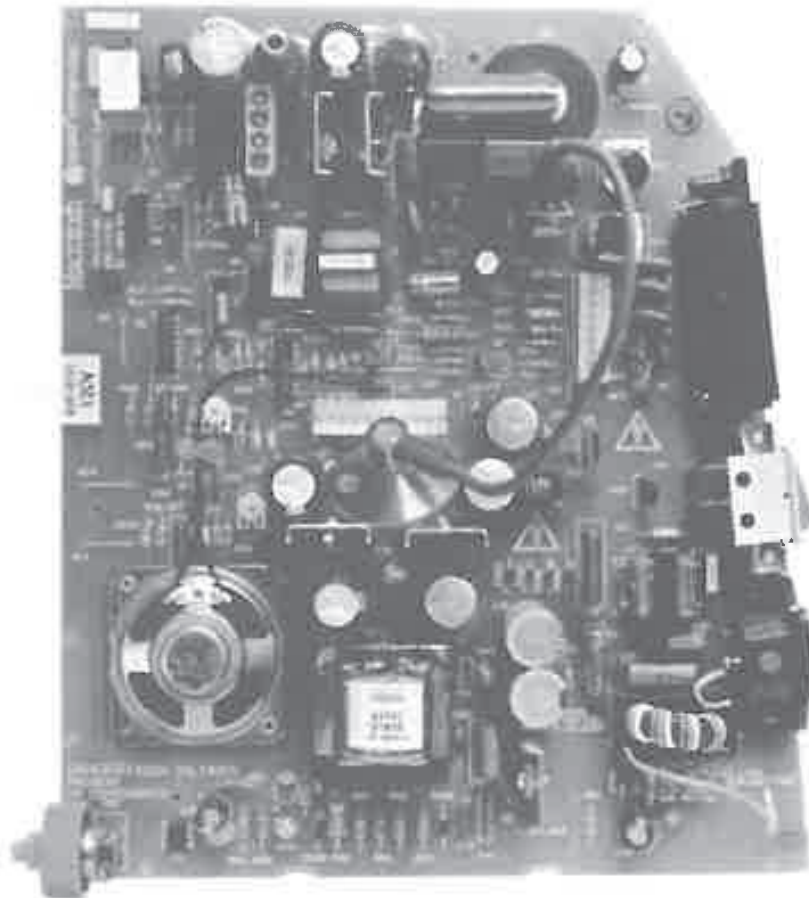

Figure 4-1 The U.S. version of the 128K to Mac Plus analog board has a 120-V power supply.

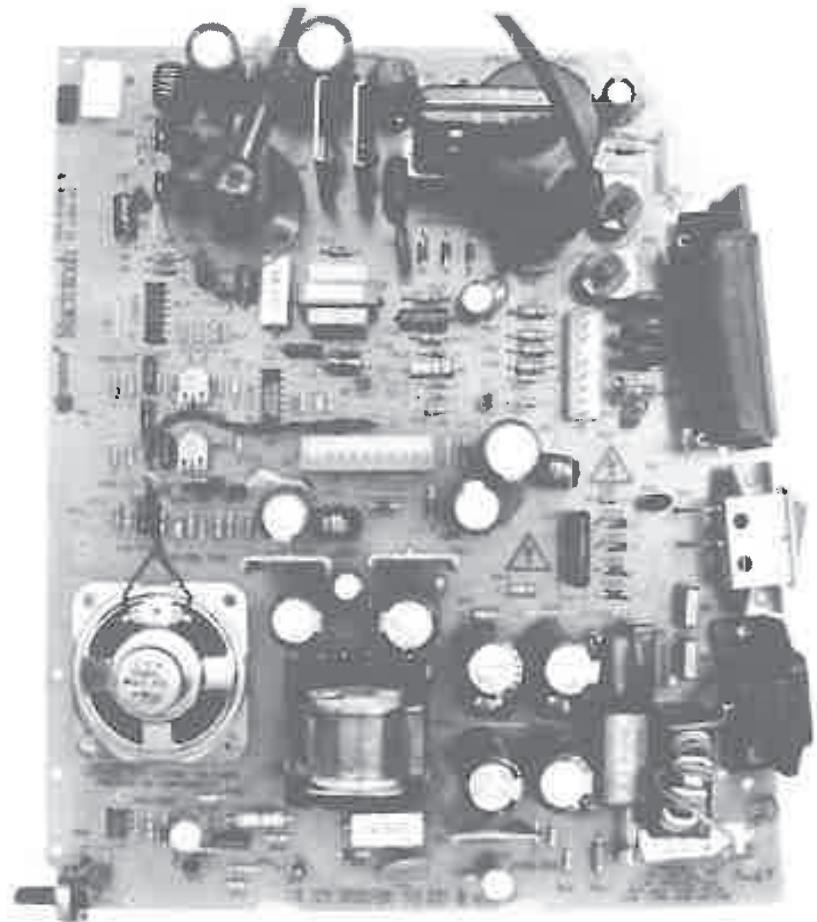

Figure 4-2 The International version of the 128K to Mac Plus analog board has a convertible 120/240-V power supply.

To determine which version of the analog board you own, study the vinyl board jacket. If it's a 120/240-V board, it'll be marked "INTERNATIONAL" in big red letters as shown in Figure 4-3. If it's a 120-V board, the word "INTERNATIONAL" will be missing. In case the vinyl jacket is missing, study the component side of the board. Look in the lower right corner, just below the line fuse, board reference F1. As summarized in Table 4-1, International boards have a 120/240-V conversion sticker in that area.



Figure 4-3 The 120/240-V board jacket is marked “INTERNATIONAL” in big red letters.

Table 4-1 International Analog Board—120/240-V Conversion Details

Jumper Status	Line Fuse	Configuration
W12 in place	2.5 A 250 V	Correct for 120 V AC
W12 removed	1.6 A 250 V	Correct for 240 V AC

Another way to identify the boards is to study T3, the power transformer. On the U.S. version, it's part number 157-0025-A. On the International version, it's part number 157-0047-A. Complete parts lists for both boards are in Appendixes C and D.

In order to apply the information in this chapter, you have to determine which version of the analog board you own. Both boards have similar video sections (there's no difference in the adjustment procedure), but the International version has a completely different power supply. As shown in the photographs, that section of the board has more parts; consequently, the board references are different. If you bought your Mac in Europe, or if you're plugging the Mac directly into an overseas 240-V outlet without an external power converter, pay special attention to the International notes which are scattered throughout the text.

Dealing with the Vinyl Jacket

In order to replace faulty components, the first thing you have to do is desolder them. Before you can do that, you have to remove the vinyl jacket which covers the solder joints. Removing that jacket is actually a lot harder than you might think. Four bothersome steps are involved:

1. Shut down—Disconnect the power cord
2. Pry off the vinyl jacket—Clean up the board
3. Clean up the jacket—Prepare it for reinstallation
4. Scrub up—Clean up the work area

The middle two steps are genuine pains-in-the-neck!

1. Shut Down—Disconnect the Power Cord

Shut down the computer (if necessary), and switch it off. Then, for safety, disconnect the power cord from the wall outlet. Physically removing the power cord from the wall outlet before proceeding is very important. Merely switching off the set does not remove power! Think about it. An ON/OFF switch can't supply power, unless it has power. As shown in Figures 4-4 and 4-5, as long as the power cord is connected, every component between the cord and the power switch is still alive! Removing the vinyl jacket is hard enough as is, without having to worry about live electrical connections. Be smart. Play it safe. Disconnect the power cord before beginning!

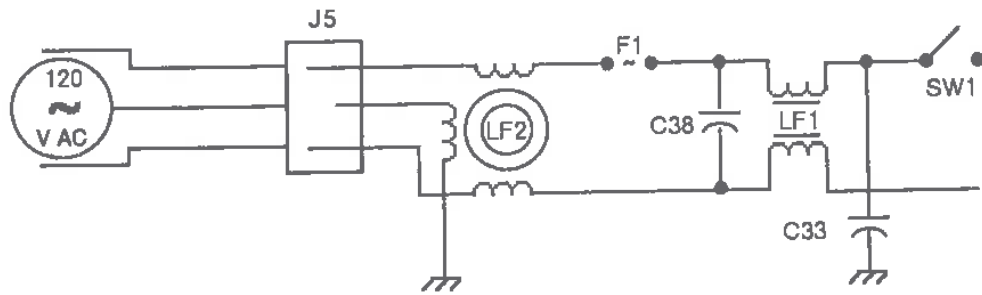

Figure 4-4 The ON/OFF Switch. As long as the power cord is connected, every component between the cord connector (marked J5) and the power switch (marked SW1) is still alive!

2. Pry off the Vinyl Jacket—Clean up the Board

With the power cord safely disconnected from the wall outlet, spread out a towel and lay the computer on its right side (as seen from the front) so that the vinyl jacket side is facing up. As shown in Figure 4-5, the jacket is attached to the analog board with three sticky pads.

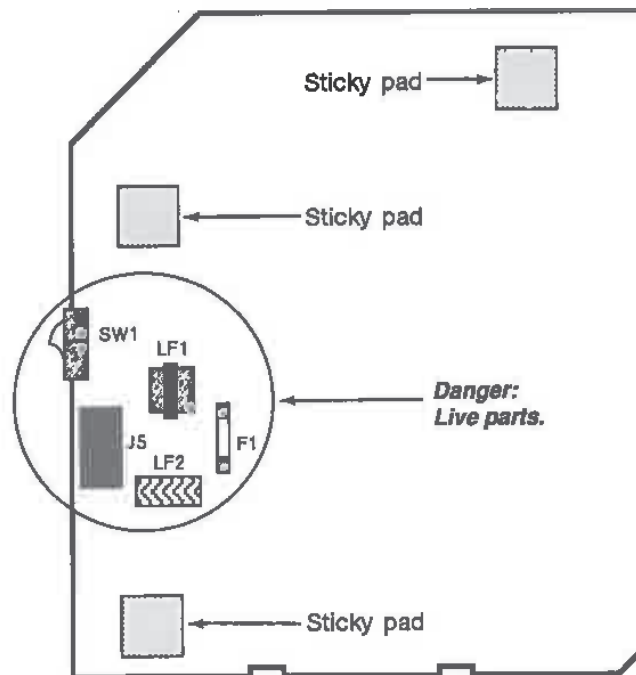

Figure 4-5 Original sticky pad locations. Note that when the power cord is connected the area under the middle pad is always alive, even when the power is switched off.

The objective is to remove these pads without leaving behind a mess. Start from the bottom of the jacket. The bottom of the board normally runs cooler than the top of the board; consequently, the lower pad comes up easiest. Insert a fingernail under the pad to get it started, and peel back the jacket very slowly. If the pad starts to tear, try to get your nail under it again, and start over. These pads are stuck harder than any price tag or disk label that you've ever seen. Whatever adhesive you fail to get up this way will have to be painstakingly peeled away by hand. Work slowly!

When the lower pad is up, check to make sure the power cord is disconnected from the wall outlet, and start on the pad just above the power switch. When that pad is up, move to the upper pad. This area of the board normally runs very hot, and the upper pad is usually baked on. If that's the case, it will tear, leaving a big mess. The only way I know of to get it out is to scrape it away with your fingernails. If you try to use solvents or any kind of a tool, you'll probably damage the board. Unfortunately, all of the sticky mess has to come off!

3. Clean the Jacket—Prepare it for Reinstallation

If you're lucky, most of the mess will stick to the jacket instead of the circuit board. This also has to be removed, and the easiest way to do it is with a putty knife as shown in Figure 4-6.



Figure 4-6 Cleaning the jacket. The easiest way to remove the old pads is with a putty knife.

When the jacket is perfectly clean, you can prepare it for reinstallation. Cut three pieces of double-sided 1-inch foam tape to size. Make them approximately 1-inch square. Install the new pads as shown in Figure 4-7. Be sure to relocate the upper pad! The original location (right over the J-1 connector) is a major high-voltage hot spot. If you don't want to go through this again, move the pad to the left as shown.

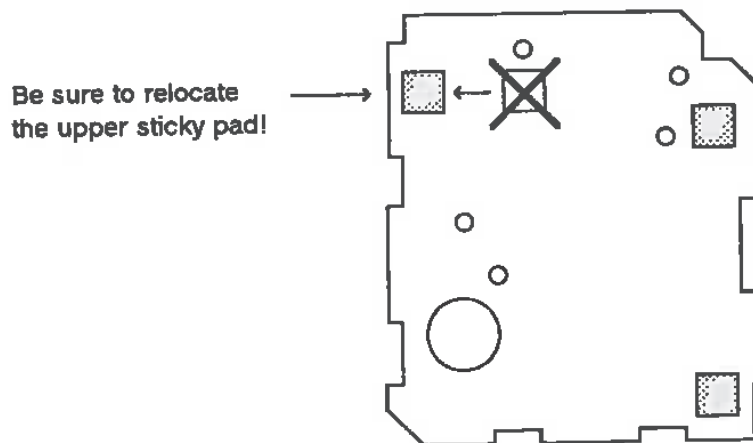

Figure 4-7 Replacement pad locations. Be sure to relocate the upper pad! The original location (right over the J-1 connector) is a major high-voltage hot spot.

Take care when choosing double-sided foam tape. Some brands stick fine but peel off easily, just like better disk labels. Other brands feature permanent stick. This stuff is grueling to remove. If you want OEM quality, buy permanent stick. If you want it to go better the next time, choose something that's made to come off.

4. Scrub up—Clean up the Work Area

At this point, you have to stop, clean up, and scrub up. Don't try to proceed with sticky hands and sticky stuff all over the place. It just doesn't work. Everything you touch will stick to your fingers. You won't even be able to put the soldering iron down without it following you out of the holder. Think of yourself as a surgeon, and think of the workbench as your operating table. It has to be clean. If you're constantly fighting a sticky mess, you won't be able to concentrate. You'll never get anything fixed.

Low Voltage

When you can't adjust for 5.00 V, it usually means you've got a bad zener (pronounced zee'-ner) diode. On the U.S. analog board the two suspects are CR18 and CR19. Letter-number combinations like CR18 and CR19 are called board references. If you look in Appendix C, the parts list for the U.S. analog board, you'll find that CR18 is a 12-V, 5-W zener, generic part number 1N 5927, and that CR19 is a 6.2-V, 1/2-W zener, generic part number 1N 5234B. Now, why bother referencing 1N 5234B with CR19? Why not just say 1N 5234B in the first place? Board references are almost always used instead of generic numbers for two very good reasons:

1. The same generic part may be used over and over again. If each instance was only identified by the generic part number, how would you know which instance was which?
2. On small components, like zener diodes, the generic numbers are difficult to read. Sometimes the label faces down. Other times, it's not there at all! Board references tend to be a uniform size, they're always there, and they're generally very easy to read.

If you think about it, you'll come to the conclusion that board references are the only possible way to identify individual parts on a large circuit board.

Locating CR18 and CR19

The approximate locations of CR18 and CR19 (as seen from the solder side of the board) are shown in Figure 4-8. Stand up the set, if necessary, and face the component side of the board. Look for board reference CR18. Alongside board reference CR18, you'll find a diode labeled 1N 5927. If the power supply can't develop more than +4.80 V, that diode will have to be replaced.

When the power supply can develop +5.00 V but can't make it all the way to the crowbar level, CR19, labeled 1N 5234B, is the suspect. In that case, you can leave CR18 alone. Just replace CR19.

International Note: On the International analog board, the suspects are CR15, CR17, and CR18. All three are 6.2-V, 1/2-W zeners, generic part number 1N 5234B.

These parts are so inexpensive that you can take it on faith and just replace them, but if you're interested in proving that they're bad, here's how to do it.

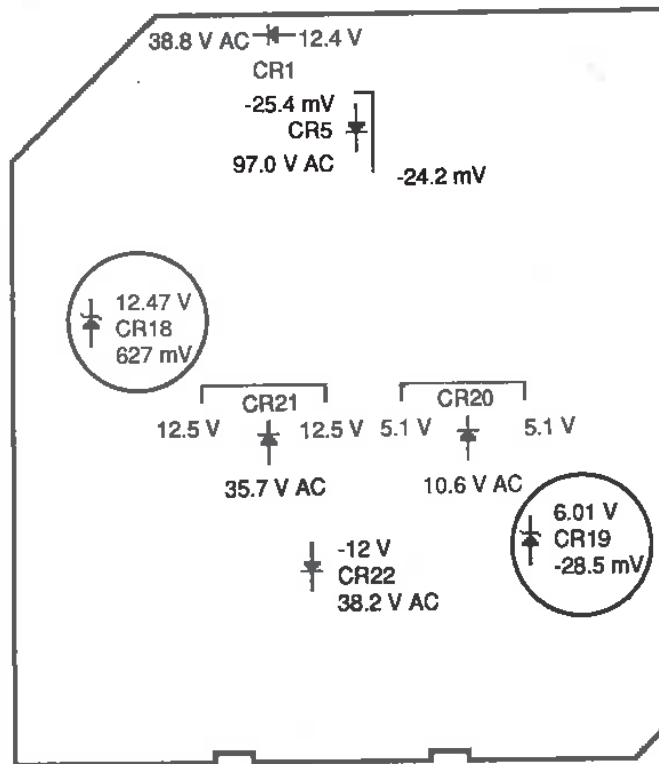

Figure 4-8 The approximate locations of CR18 and CR19 as seen from the solder side of the U.S. analog board.

Theory and Practice

The function of a zener diode is to maintain a specified voltage. The operating range of a zener diode is plus or minus 10 percent. In theory, that means a 6.2-V zener, like the 1N 5234B, should regulate no lower than 5.58 V ($6.20 - 0.62 = 5.58$), and no higher than 6.82 V ($6.20 + 0.62 = 6.82$). Anywhere within that range, the circuit should operate. Note that the word “operate” does not mean operate well. For top performance, you want these zeners to regulate as close to the specified voltage as possible.

Component Level Test Set-up

Turn on your multimeter, set it to read DC volts, and clip the black lead to the chassis. As shown in Figure 4-9, set up a small inspection light such that it shines on the component side of the board. A high-intensity lamp makes a good inspection light. You can even use a flashlight. If you aim it properly, the bright beam will shine through the board, producing an X-ray effect, making it very easy to determine which solder joints belong to which components. *You have to set up a lamp.* Without the X-ray effect, it’s almost impossible to pick out one solder joint from another.

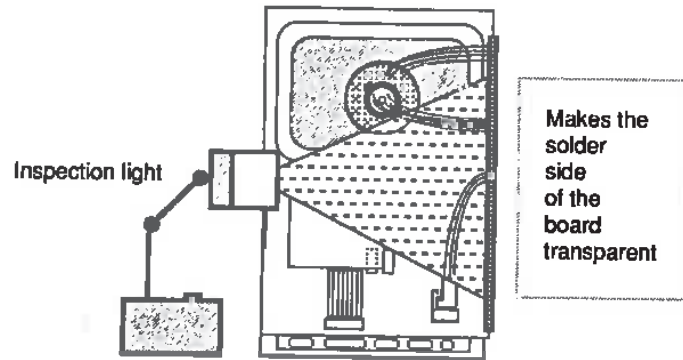

Figure 4-9 Component level test set-up. Set up a small inspection light such that it shines on the component side of the board.

Once you've set up an inspection lamp, face the solder side of the board and find the corresponding solder joints. When you've positively identified them, reconnect the power cord and switch on the set. While facing the solder side of the board, touch the red probe of your meter to each of the upper diode joints, one at a time. Observe the readings. As indicated in Figure 4-8, typical Grade-A readings are +12.25 V for CR18, and +6.09 V for CR19.

Very often you'll find that CR19 reads closer to +5.86 V. In theory, +5.86 V is within specifications, and in practice it does work, but you'll never get full voltage out of that supply until you pull the old part and replace it with a new zener—one that regulates with greater precision.

General Desoldering Procedure—Replacing the Diode

All parts on the analog board are replaced exactly the same way. The old part has to be desoldered. The new part has to be soldered in its place. Using CR19 on the U.S. analog board as an example, here's the general replacement procedure:

1. Switch off the set and remove the power cord.
2. Lay the set down, so that the solder side of the analog board is facing up.
3. Plug in a 15-watt grounded (3-wire) soldering pencil.
4. While you're waiting for the iron to heat up (it'll take about five minutes), practice with the vacuum desoldering tool. As shown in Figure 4-10, it has a spring-loaded pump and a release button.

You push the pump handle down to prime the tool, and you push the release button in to activate the suction. Read the instructions supplied with the tool. It only takes about two seconds to catch on. What's not obvious is the storage capacity. This tool is a one-shot affair, a lot like an air rifle. There's only room for one load. Every time you reprime the tool, it spits out the old solder, and if you're not careful to reprime over a can, the old solder spits out all over the place. That makes a mess.

Somehow, the instructions never seem to mention that. Don't get taken by surprise. Set up a waste-solder can!

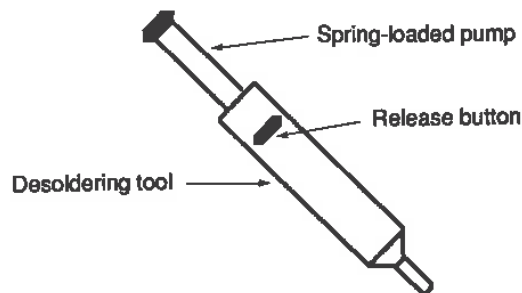

Figure 4-10 Vacuum desoldering tool. Typical tools have a spring-loaded pump and a release button.

5. When the iron seems hot, "tin" the tip by touching it to some 60/40 rosin core solder. If the solder melts and flows nicely around the tip, the iron is up to operating temperature. If the solder doesn't melt right away, wait a few minutes longer, then try it again. After tinning the tip (by melting some solder on it), touch it to a wet sponge to remove the excess solder, or wipe it clean with a wet cloth. Make it a thick cloth, and be careful. The iron is hot!
6. Hold one tool in each hand and approach the solder joint at a 45-degree angle. As shown in Figure 4-11, the tools should form a V-shape over the board. Touch the tip of the soldering pencil to the joint, then, as soon as the solder starts to melt, pry up the diode lead (assuming it's bent over) by using the soldering pencil tip as a lever. As soon as the bent-over lead is up, withdraw the iron, rotate the desoldering tool so that it's perpendicular to the board, smother the lead, and push the release button. Pop! All of the solder should go into the barrel. The joint should be nice and clean. If it isn't, you probably delayed too long. Discharge whatever solder you did remove (into a can), then reheat the joint, apply a little fresh solder, and try again. Remember, even though the barrel is quite large, it's only got a one-shot storage capacity. The entire function of that barrel is to create a vacuum. Each time you prime the tool, the waste solder spits out. If you don't prime it over a can, it'll just spit out all over the place, making a mess of the bench and creating dangerous short circuits (unwanted connections) on the analog board. This is so important, that I'll say it again. Use a can!
7. Check the desoldered leads with a screwdriver or a soldering aid. (Soldering aids are poking tools sort of like dental probes.) The leads should break away from the circuit board easily and /or move freely. If

they don't, you'll have to reheat them until they do. Generally, the desoldered diodes fall right out, but if not, you can reach around the back (make sure the power is off) and pull them out.

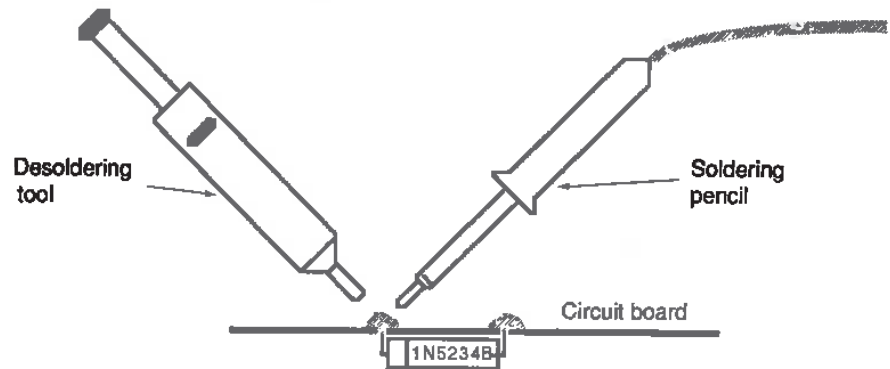

Figure 4-11 The tools should form a V-shape over the board.

8. Stand up the computer. Bend the leads on the replacement part so that it matches the one you took out, but don't cut them to size yet. Notice that one end of the diode is striped. On CR18 and CR19 (U.S. version) that stripe goes to the top. If you ever forget which way a part goes, don't guess. Check the component side of the board. As shown in Figure 4-12, it'll be marked.

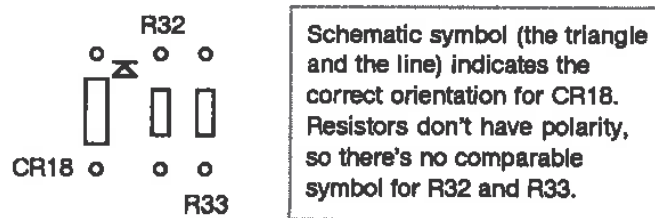

Figure 4-12 If you ever forget which way a part goes, don't guess. Check the component side of the board. It'll be marked.

On the U.S. board, CR19 is awkwardly located. You'll need to reach in between the disk drive and the CRT in order to insert the part. A pair of curved-tip 6-inch hemostats (a forceps-like tool) works well. Alternately, you can unscrew the board with a #1 Phillips-head screwdriver as instructed in Chapter 1. It's not necessary to disconnect every cable and remove the board. Just lift it up a little and slip it back a bit, until you can

reach in from the front side just enough to insert the part. Whatever method you decide to use, make sure the orientation stripe is pointing in the right direction.

9. To prevent new parts from falling out when you lay the computer back down, pull up on the leads and bend them approximately 45 degrees as shown in Figure 4-13. If you bend them all the way down to 90 degrees, you'll have a heck of a time getting them back out again, should that ever become necessary. If you unscrewed the board, reposition it, reinstall any wiring harnesses you disconnected and retighten the screws.



Figure 4-13 To prevent new parts from falling out when you lay the computer back down, pull up on the leads and bend them approximately 45 degrees.

10. Lay the computer back down so that the solder side of the analog board faces up. With the soldering pencil in one hand and a roll of solder in the other, approach the new lead at a 45-degree angle. The tools should form a V-shape over the board. As shown in Figure 4-14, touch the tip of the soldering pencil to one side of the lead, just where it comes out of the board, and touch the solder to the other side of the lead. Don't rest the soldering pencil against the board itself! Hold the iron just above the board. Let gravity pull the solder down.

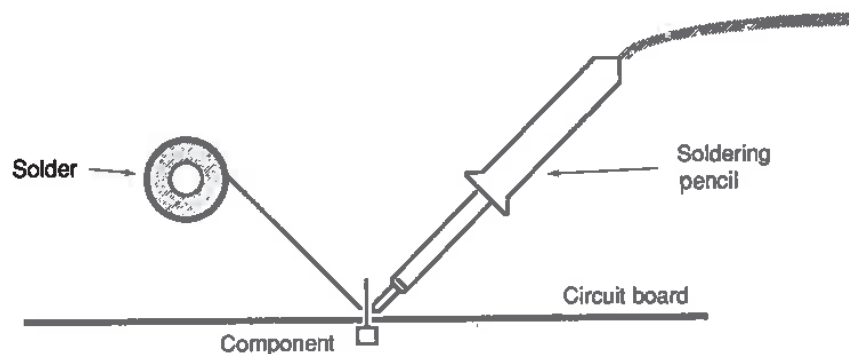

Figure 4-14 Soldering technique. Touch the tip of the soldering pencil to one side of the lead, just where it comes out of the board, and touch the solder to the other side of the lead.

When the solder starts to melt, hold the iron in place just long enough for it to flow all the way around the joint. You don't want to boil the solder, and above all you don't want to burn the board. As soon as the solder wicks around the joint, withdraw the soldering pencil and let the joint harden. Wait four or five seconds for it to shine over, then move to the other lead.

11. When both leads are soldered, clip off the excess with a pair of small wire cutters (nippy-style cutters are best). Clip the leads as close to the joint as possible, without cutting into the joint itself. Make sure to track down any pieces that fly off. Throw them in the waste-solder can so you don't wind up with an unexpected short circuit later.
12. Remove all soldering tools from the immediate work area, and clean up the bench.

Checking Your Work

Stand up the Macintosh. Turn on your multimeter. Set it to read DC volts, and clip the black lead to the chassis. Reconnect the power cord and switch on the set. Touch the red probe of your meter to the top of the new diode. Unless you got a defective part (it does happen), CR19 should be regulating much closer to the specified voltage. 6.01 V to 6.09 V is typical. Insert the red probe into the middle socket of the logic board connector as outlined in Chapter 3, or use one of the voltage checking methods described in Chapter 2. When you adjust the voltage pot now, you shouldn't have any trouble triggering the crowbar circuit. Watch the meter for 5.35 V to 5.40 V. As soon as you see 5.40 V, or hear the bong, flup, flup, flup noise, readjust for 5.00 V to 5.01 V. Remember, don't let the overvoltage situation continue very long. To prevent damage to the flyback circuit, back off the voltage pot immediately! Once you reestablished 5.00 V to 5.01 V, switch off the set, remove the power cord and reattach the vinyl jacket. Proceed to the next section for further information.

Fluctuating Voltage

Sometimes, on an otherwise good supply, you get everything set up perfectly, and the next day, the adjustments are way off again. You check the voltage, and it's down, sometimes by as much as .10 V! Then, later on, everything checks OK. What's happening? Usually, the multicolored wiring harness that runs from the analog board to the logic board is responsible. Primarily because of corrosion, two things go wrong with it:

1. The resistance of the crimp connections varies
2. The resistance of the pin/socket surfaces varies

In addition, there are at least two OEM versions of the harness. One version is made from medium-duty 20-gauge wire. These usually hold up

pretty well. Another is made from light-duty 22-gauge wire. These should not be used with memory upgrades. In either case, the permanent fix involves four simple steps:

1. Remove the old wiring harness
2. Clean the board connectors with a liquid metal polish
3. Treat the board connectors with a chemical stabilant
4. Install a heavy-duty 18-gauge replacement wiring harness

1. Removing the Old Harness

The easiest way to remove the old wiring harness is to grab it by the wires and pull it off. Use a rocking motion to unseat the connector locks and pull straight up as shown in Figure 4-15. If you try to grab the connector with a pair of pliers, you'll never get anywhere, the tool may slip, and the opposing force may drive the metal handle into the glass CRT. Metal breaks glass. Regardless of what you've been taught, don't use pliers on the harness connectors! Because of the CRT implosion danger, always put on goggles for safety.

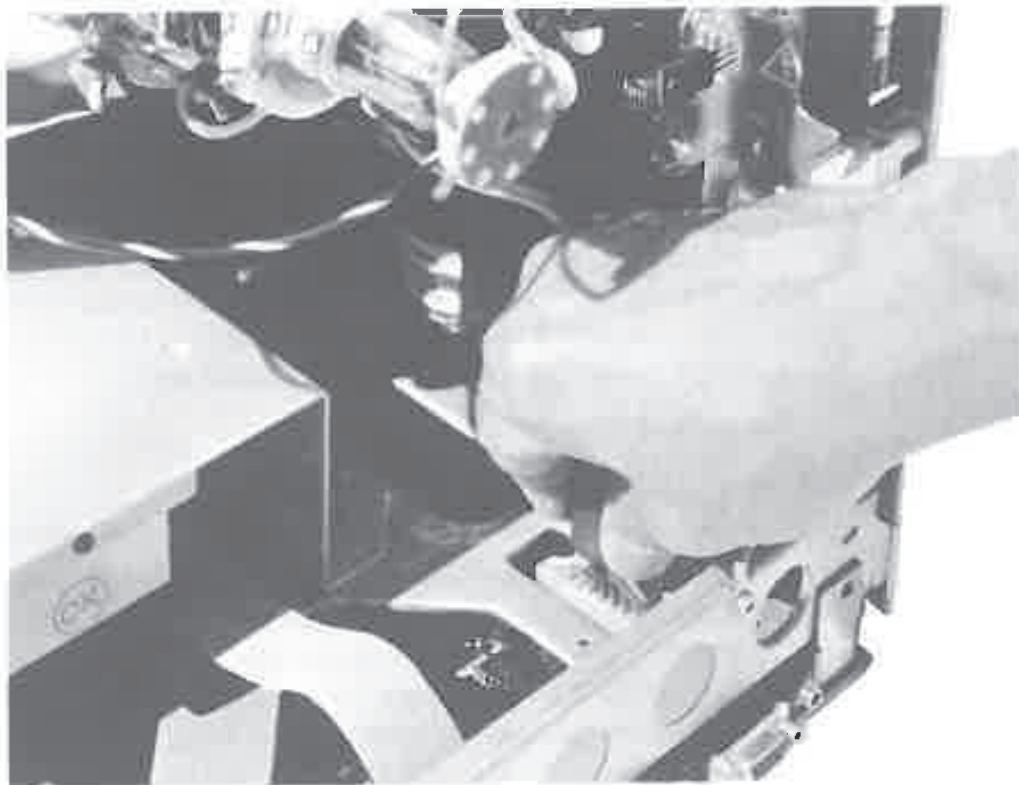

Figure 4-15 The easiest way to remove the old wiring harness is to grab it by the wires and pull it off.

In defense of this "pull-it-by-the-wire" technique (which is generally very bad procedure), the harness is tie-wrapped and bound. That combination makes it very strong. Don't worry about breaking the wires. My shop Mac has been disconnected this way dozens of times, maybe even a hundred times. It's still got the same 20-gauge harness, and it's still working fine.

2. Cleaning the Board Connectors

Once the harness is off, inspect the board connectors. The pins should be nice and shiny. If they appear to be a uniform dull gray, they're tarnished. The same way that rust bubbles away the paint on a car, the tarnish actually separates the contact surfaces. This separation causes high-resistance connections which result in voltage fluctuations. Use a cotton swab and some liquid silver polish to shine up the pins. Don't bother with the connectors on the cable ends. The sockets on these connectors are toothpick size, making them impossible to clean.

3. Treating the Board Connectors

The problem with tarnish is that once it occurs, it tends to recur. You can minimize that by treating the pins with a stabilizing chemical. This material fills all of the crevices in the metal. That maximizes the metal-to-metal contact area, making it more difficult for corrosion to set in again. Snake oil? No, not at all. This stuff works. You can actually measure the results!

4. Testing a Replacement Harness

For top performance with memory upgrades, either size (22-gauge or 20-gauge) harness can be replaced with a heavy-duty 18-gauge harness. All three plug in the same way. They're all the same length, and they all use the same color codes. What's the difference? Wire gauges are like golf scores. Low numbers are better than high numbers. In this case, the substantially thicker wires make a measurable difference; even moreso when the pins have been treated with stabilant.

You can prove it by taking readings at both ends of the harness. Reinstall the cable (if it's still on the bench,) turn on your meter, and set it to read DC volts. Clip the black lead to the chassis and insert the red probe into socket 6, alongside the blue wire in the logic board connector (marked J7). Remember, socket 2 is empty, so be sure to count sockets, not wires. Switch on the Macintosh and adjust for +5.00 V as described in Chapter 3. Now touch the red probe to the middle wire of the analog board connector (marked J3) and observe the reading. Note that it's substantially greater than +5.00 V. Typically, it's anywhere from +5.03 V to +5.10 V! That difference (between the analog and logic board connectors) is the measurable voltage drop across the harness! In other words, you might have to crank the circuit all the way to

5.10 V just to supply 5.00 V to an upgraded logic board. When you repeat the tests with an 18-gauge harness, you'll observe less than .01 V difference. You'll have to turn the voltage down, because the reading on the logic board will be up. These effects are illustrated in Table 4-2.

Table 4-2 Voltage Drop Across the Power Supply Harness

J3 connector	5.10 V	5.03 V	5.01 V
Wire gauge	22 AWG	20 AWG	18 AWG
J7 connector	5.00 V	5.00 V	5.00 V
Voltage drop	0.10 V	0.03 V	<.01 V

If you measure from the solder side of the connectors, then treat the pins with chemical stabilant and remeasure, the readings will go even higher! To compensate, you'll have to back off the voltage adjustment a second time.

Remember, it's not actually necessary to test any of this. When you've cleaned the pins, treated the pins, and replaced the harness, the fluctuating voltage problem will be gone. Finish up by readjusting the set as explained in Chapter 3.

Focus Control Problems

When the focus control has no effect, or an intermittent effect, it's usually due to one of three problems:

1. Burned resistors in the focus circuit
2. Loose or corroded CRT socket cable
3. Tarnish on the CRT pins

The relationship between these parts (U.S. analog board) is shown in Figure 4-16. International part numbers are given in the text. Color codes for use with Figure 4-16 are shown in Table 4-3.

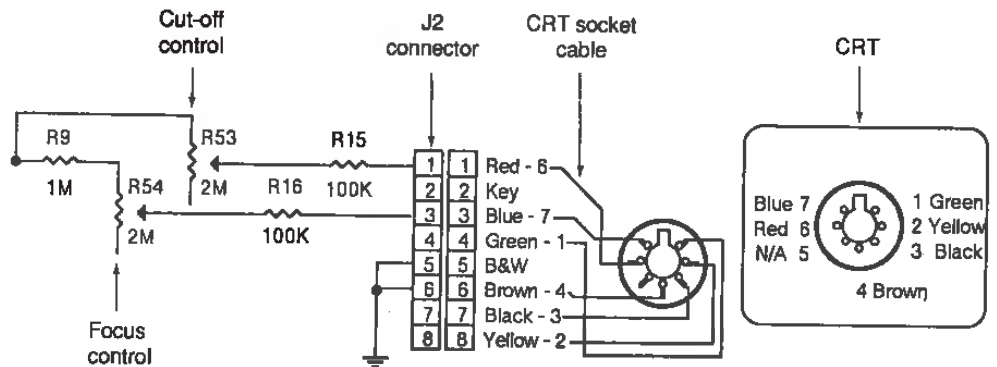

Figure 4-16 When the focus control has no effect, or an intermittent effect, it's usually due to:

1. Burned resistors in the focus circuit
2. A loose or corroded CRT socket cable
3. Tarnish on the CRT pins.

Table 4-3 Color Codes—CRT Socket Cable

J2-pin	Color	Function	CRT-pin
1	Red	Cut-off	6
2	N/A	Key	N/A
3	Blue	Focus	7
4	Green	Brightness	1
5	B&W	Ground	N/A
6	Brown	Ground	4
7	Black	Heater	3
8	Yellow	Cathode	2

1. Burned Resistors—No Focus

When the focus control has absolutely no effect, the primary suspects are burned resistors. Begin your inspection by making sure that the computer's power cord is physically disconnected from the wall outlet. Next, stand up the set (if necessary), and locate board references R16 and R9. In Figure 4-17, suspect resistor R16 is directly in line with the pointer; suspect resistor R9 is two resistors up, just below the flyback transformer. Nine times out of ten, this area looks fine. Nevertheless, one or both of the resistors will test "open," suggesting that they've been over-heated.

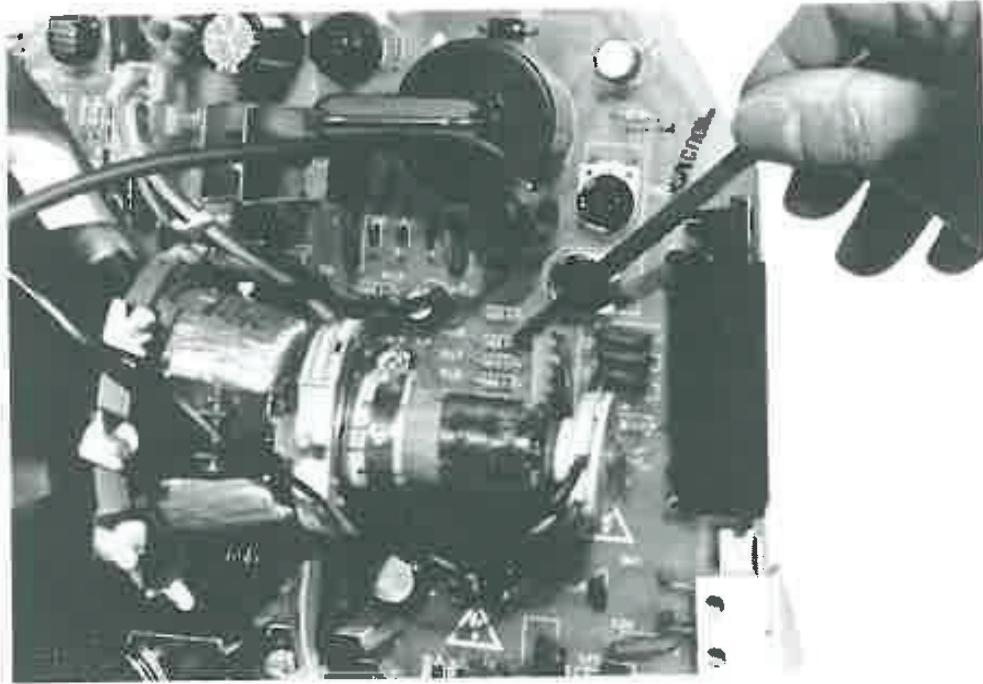

Figure 4-17 Focus suspects, U.S. analog board. Suspect resistor R16 is immediately in line with the pointer; suspect resistor R9 is two resistors up, just below the flyback transformer.

International Note: On the International analog board, the suspect resistors will be labeled R20 (instead of R16) and R12 (instead of R9). Look for them in exactly the same spots.

Testing the Resistors Turn on your multimeter and set it to the megohm ($R \times 1M$) scale. Set up an inspection lamp. Next, check to make absolutely sure the power cord is physically disconnected from the wall outlet. When you're sure, face the solder side of the board, and touch one probe to one side of resistor R16 and touch the other probe to the other side. (Either color can go to either side.) Observe the meter reading. Compare it to Table 4-4. A good in-circuit reading for R16 (R20 on the International board) is typically $101\text{ k}\Omega$ (kilohms). If the digital meter indicates over-range or if your analog meter shows infinity, R16 is burned (open). It will have to be replaced. Now, touch one probe to each side of resistor R9. A good in-circuit reading for R9 (R12 on the International board) is $824\text{ k}\Omega$. If the digital meter indicates over-range or if either type meter shows $3.5\text{ M}\Omega$ (megohms), R9 is burned. It will also have to be replaced.

Table 4-4 In-circuit Test Results—Meter Set for R×1M

U.S.	Int	Value	Good	Bad
R9	R12	1 MΩ	824 kΩ	Over-range or 3.5 MΩ
R16	R20	100 kΩ	101 kΩ	Over-range or infinity

To keep the replacement parts from burning again, always use 1/2-W resistors, even if the originals were 1/4-W. 1/4-W resistors do work, but 1/2-W replacements (which are somewhat larger) hold up better to high operating temperatures.

To actually replace resistors R9 and R16, refer to the general desoldering procedure given earlier, in the section titled “Low Voltage.”

Checking Your Work Once the new parts are in, clear the work area and boot up with the TPG/System disk. Launch TPG, and choose Focusing Text from the Test Patterns menu. Working from the solder side of the board, insert the screwdriver end of a plastic TV alignment tool into the focus control, board reference R54 (R58 on the International board). Check the vinyl jacket to confirm the location, or choose Mac Video Alignment from the Reference Menu. As you turn the control (gently) from one extreme to the other, the display should go in and out of focus. If it does, consider the problem fixed. Shut down, disconnect the power cord and reattach the vinyl jacket. Reconnect the power cord, boot up again, and return to Chapter 3 for further instructions.

2. Loose or Corroded Contacts on the CRT Socket Cable

When the focus control works normally but stops working as you turn up the brightness control, the problem is usually due to a loose or corroded CRT socket cable. As shown in Figure 4-18, this cable runs from the J2 connector on the analog board to the thin glass neck of the CRT. Sometimes, as the result of heat-related expansion and contraction, the CRT end of the cable loosens. Other times, it's jarred loose during transportation. More often than not, it loosens as the result of upgrade and repair work. Inadvertently, you brush against the cable, and it slips 1/32 inch or so. Corrosion starts on the uncovered mating surfaces, and eventually you end up with a problem similar to the fluctuating +5.00-V problem described earlier.

The usual fix simply involves disconnecting the power cord (from the wall outlet) and gently pushing the socket cable all the way home. Make absolutely sure the power cable is disconnected before trying this, use only one hand, and put on goggles for safety. Remember, the CRT is made of glass. The neck is extremely fragile. It's probably only slipped 1/32 inch or so. A gentle little push is all it's going to take.

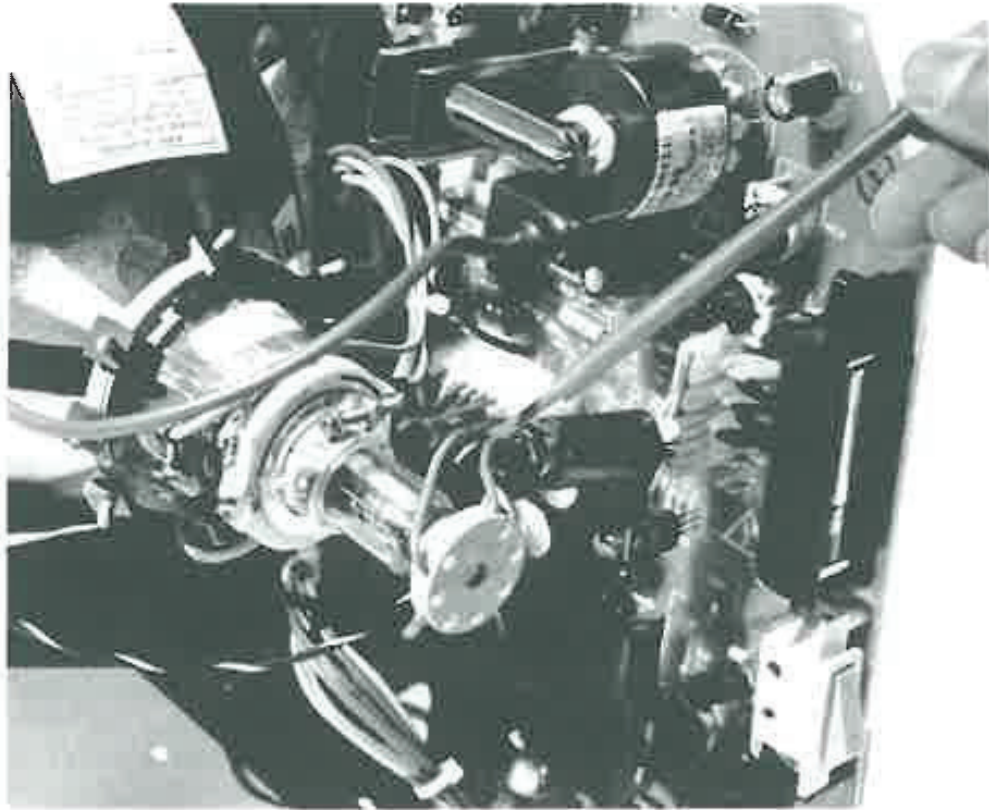

Figure 4-18 The CRT socket cable runs from the J2 connector on the analog board to the thin glass neck of the CRT.

Although it might seem like a good idea, don't apply stabilant chemical to the CRT socket connectors. If you do, the cut-off circuit will temporarily stop working. The screen will become overly bright, and while it doesn't seem to do any permanent damage, you'll have to wait a few hours for everything to return to normal in order to adjust the set.

3. Tarnish on the CRT Pins

If snugging up the CRT socket cable doesn't work, you've probably got tarnished pins on the neck of the CRT. Shut down, and disconnect the power cord from the wall outlet. Unplug the CRT end of the cable as shown in Figure 4-19.

The CRT pins are made of copper. Ideally, they should be clean and shiny like the bottom of a new copper pan. If they're streaked with dark blue, you've definitely got a problem. For the same reason that a discolored copper pan doesn't heat evenly, discolored copper pins don't conduct properly. Clean them with cotton swabs dipped in metal cleaner, dry them carefully, reattach the cable, and everything will be OK.

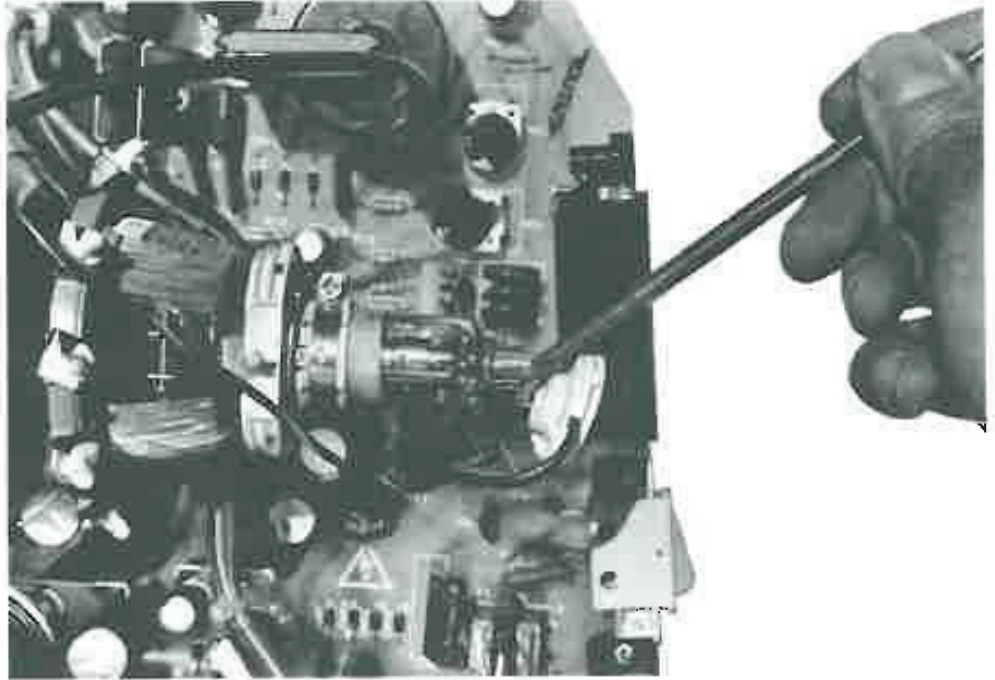

Figure 4-19 Unplug the cable to inspect the CRT pins for tarnish.

Personal Note: The first time I came across this problem, I replaced R9 and R16 on principle, even though they weren't open (because I'd seen them fail before), thinking they might be thermally intermittent. When that didn't work, I took apart the CRT socket cable and soldered all of the crimp connections. When that didn't work, I replaced the CRT socket cable with a new one, thinking it might be thermally intermittent. When that didn't work, I tried a stabilant chemical which produced the bizarre results described above. Finally, just when I was ready to give up (and order a new CRT), I smartened up and polished the CRT pins. That was it! Since then, I've worked this same magic over and over again. You may not find this tip in any textbook, but when all else fails (assuming you've got a focusing problem), polish the CRT pins!

Brightness Control Problems

When you can't turn up the brightness without causing excessive distortion (referred to as buckling and blooming), it's a sure sign of leaky electrolytic capacitors. On the U.S. analog board, the suspects are C3, C24, C25, C26, C29, C30, and C31. On the International analog board, the suspects are C3, C24, C27, C28, C30, C31, and C32. These parts are so inexpensive, you can take it on faith and just replace them (look in Appendixes C to F for generic part information), but if you're interested in proving that they're bad, here's how to do it.

The following procedure presumes an autoranging digital multimeter with autopolarity feature. Turn on the multimeter, set it to read DC volts, and clip the black lead to the chassis. As shown in Figure 4-9 (a few pages back), set up a small inspection light such that it shines on the component side of the board. Once you've set up the inspection lamp, switch on the Macintosh and face the solder side of the board. Using Figure 4-20 for the U.S. analog board (Figure 4-21 for the International analog board) as a guide, locate the suspect solder joints and touch the red multimeter probe to each of the joints one at a time. For reference, make a list. When you're finished, compare the list to the typical readings marked in the diagram.

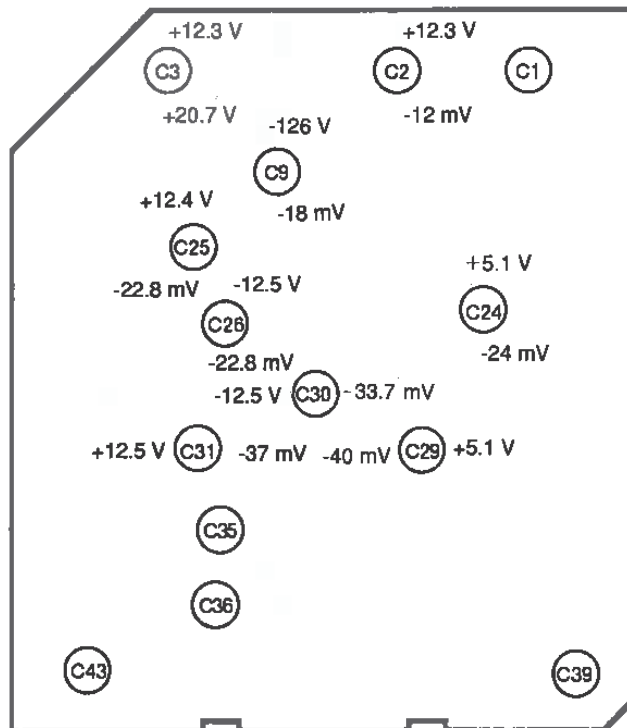

Figure 4-20 The approximate locations of C3, C24, C25, C26, C29, C30, and C31 as seen from component side of the U.S. analog board.

The negative millivolt readings shown on the diagrams indicate leakage. Leakage increases with age. The closer the readings are to zero, the better. High negative millivolt readings indicate low leakage. Low negative millivolt readings indicate high leakage. New capacitors average -20 mV. -100 mV indicates imminent failure. For that reason, whenever any one of the suspects shows less than -100 mV of leakage (logically, -100 mV is less than -20 mV), or if they're just all on the low side (indicating high leakage), every cap on the list should be replaced.

Electrolytic capacitors are like spark plugs or flashlight batteries. They work as a team. When one fails, you can assume that the others are equally ready to fail, even if they don't test bad. Replacing leaky capacitors is a major part of the power supply upgrade procedure described in Chapter 6. We'll have more to say about it then.

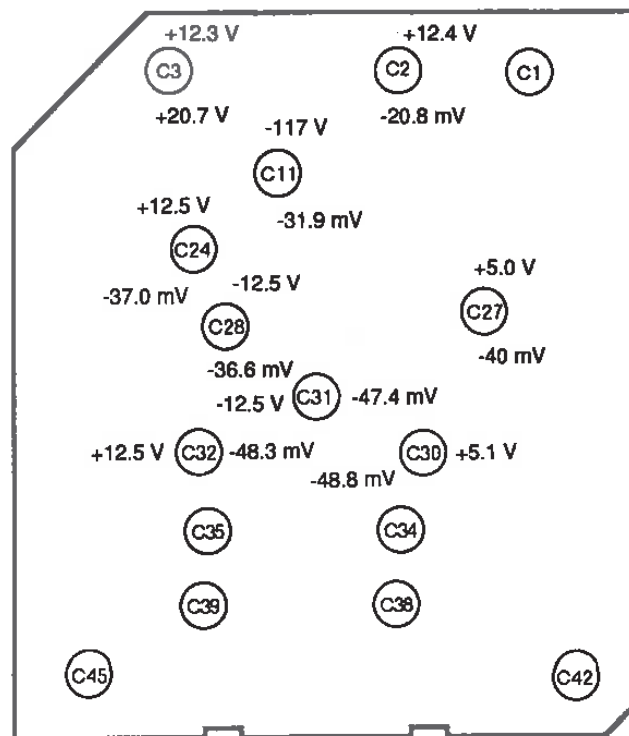

Figure 4-21 The approximate locations of C3, C24, C27, C28, C30, C31, and C32 as seen from component side of the International analog board.

To measure electrolytic leakage with an analog multimeter (one with a needle pointer and a scale), set it to the lowest DC volts scale and clip the *red* lead to the chassis. Using Figure 4-20 for the U.S. analog board (Figure 4-21 for the International analog board) as a guide, locate the actual solder joints and touch the *black* multimeter probe to each of the negative millivolt (mv) joints one at a time. For reference, make a list. When you're finished, compare the list to the typical readings marked in the diagram.

Summary

When the computer fails to respond to the tune-up procedure, it means you've got one of three common problems. Low voltage is usually the fault of bad zener diodes but sometimes it results from voltage drop across the power supply harness. Focus problems indicate open resistors or a problem with the CRT socket cable. Buckling and blooming indicate leaky electrolytic capacitors. The symptoms and solutions given in this chapter are real, not hypothetical. Follow the instructions, and you will solve the problem.

In the next chapter we'll look at common video problems. We'll talk about displays that collapse to a thin white line and explain what to do with displays that fade, darken, and disappear altogether.

CHAPTER

5

Video Problems

When the computer powers up normally (when it bongs on startup) but the display flickers and/or quits, it usually means trouble with one of the following parts:



Display Symptom	Solution
1. Collapses to vertical line	Resolder C1, J1, L2 Replace C1 Replace LAG chip on logic board
2. Jitters and/or has worms	Replace T1
3. Makes a ringing noise	Replace T1
4. Makes an ozone smell	Replace T1
5. Distorts severely/fades/darkens	Replace Q3 (INTERNATIONAL Q2), T1
6. Makes a burning smell/smokes	Inspect/replace C1, J1, L2 Replace Q3 (INTERNATIONAL Q2), T1
7. No raster, completely dark	Resolder pins 1 and 3 on J4 Replace U2 Replace LAG chip on logic board
8. Collapses to a horizontal line	Resolder pin-5 on J4. Suspect Q1, Q2 (INTERNATIONAL Q4) Suspect R2 and R3
9. Collapses to a pinprick	Reconnect CRT yoke cable

In most cases the problem is at the top of the analog board in the area of C1, J1, L2, Q3 (INTERNATIONAL Q2,) and T1. The schematic relationship between these parts is shown in Figure 5-1. Note that Q3 is marked Q2 on the International analog board. The other suspects, C1, J1, L2, and T1, the yoke cable color codes, and all of the J-X connector assignments are the same for both boards. For reference, these are listed in Tables 5-1 and 5-2.

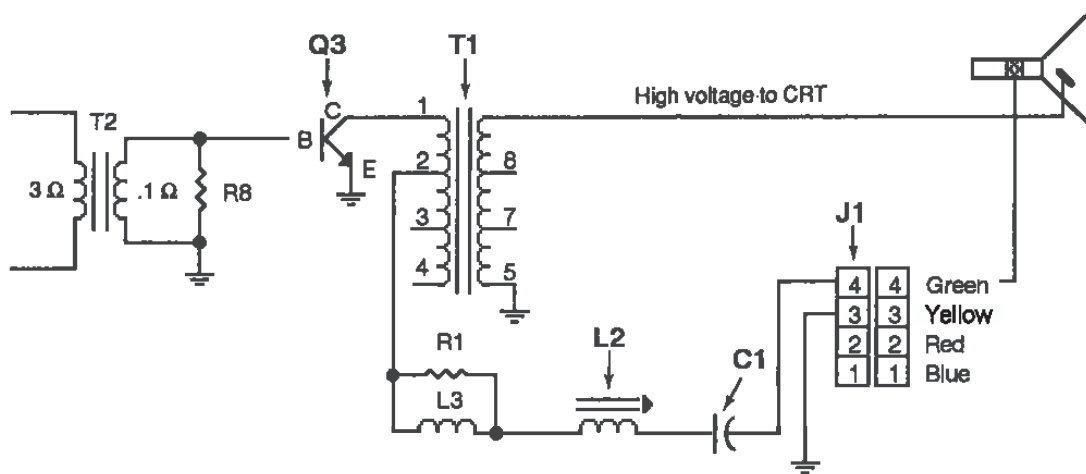

Figure 5-1 The schematic relationship between C1, J1, L2, Q3 (INTERNATIONAL Q2), and T1.

Table 5-1 Connector Assignments—Macintosh Analog Board

Connector	Pins	Function
J1	4	Analog board to CRT yoke
J2	8	Analog board to CRT socket
J3	2	Analog board to internal speaker
J4	11	Analog board to logic board
J5	3	Analog board to AC power

Table 5-2 Color Codes—J1 Connector to CRT Yoke Cable

J1-pin	Color	Function
4	Green	Horizontal yoke
3	Yellow	Ground
2	Red	+5.00 V
1	Blue	Vertical yoke

Just for the record, each of the symptoms discussed in this chapter is real, not hypothetical, and the solutions given are proven, not theoretical. With the Macintosh repair secrets about to be revealed, you can go right to the heart of the matter each and every time.

Display Collapses to a Vertical Line

When the display collapses to a vertical line, it means you lost the horizontal sweep. If it collapses to a horizontal line it means you lost the vertical sweep. (Note that it's a reverse relationship.) If it collapses to a pinprick, it means you lost both sweeps. Here's how it works:

We already know that the display contains 175,104 individual dots (512 × 342). Each dot measures 1/72-inch square, and they all fire one after the other at very high frequency. The dots are displayed unidirectionally, like the characters in TPG's focusing text, but the action is much faster. The sweep circuits control the firing order. The horizontal sweep controls the side-to-side (horizontal) movement. The vertical sweep controls the down-and-up (vertical) movement. The first dot to ignite is the one in the upper left corner of the display. The next dot to be displayed is exactly to the right of the previous dot, and so on, until the end of the line is reached. At that time, the vertical sweep pulls the beam down one dot. Then, the horizontal sweep retraces to the beginning of the next line and starts to the right again. Each sweep circuit works independently of the other. The horizontal sweep is constantly pulling the beam left and right like the carrier mechanism on a printer. The vertical sweep is constantly pulling it up and down like the line-feed mechanism on a printer. If the display collapses to a horizontal line, the fact that there *is* a horizontal line proves that the horizontal sweep is OK. If the display collapses to a vertical line, the fact that there *is* a vertical line proves that the vertical sweep is OK.

All you have to remember is that there's a reverse relationship between what you see on the screen, and what the problem is. If what you see on the screen is going up and down, it means you've got a problem going left and right. If what you see on the screen is going left and right, it means you've got a problem going up and down. No left-and-right action indicates a horizontal problem. No up-and-down action indicates a vertical problem. Dwell on the

fact that there is a reverse relationship between what you see on the screen, and what the problem is, and you'll never forget the difference.

On the 9-inch Macintosh, the usual problem is with the horizontal sweep. Generally, the display collapses to a vertical line as shown in Figure 5-2. If the trouble is intermittent, if you can restart the Mac and the sweep comes back, or if you can tap the case and get the sweep back, it means you've got a cracked solder joint in the area of L2, C1, and J1.

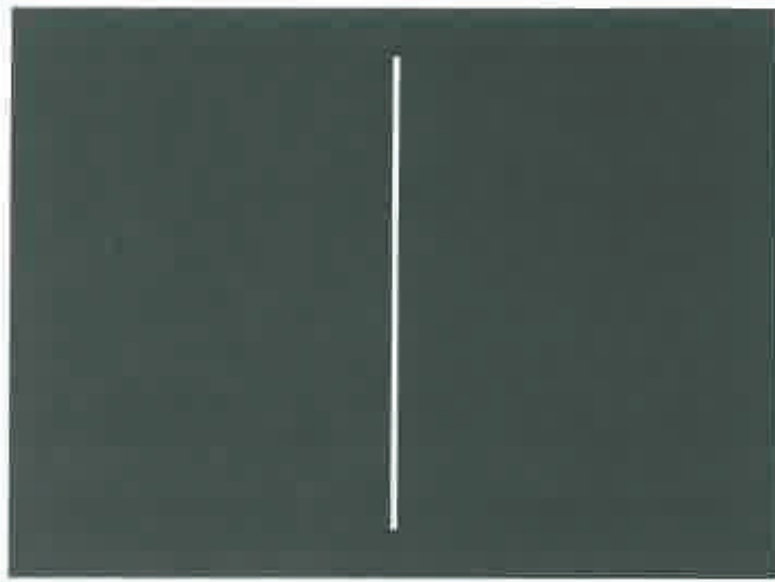

Figure 5-2 No horizontal sweep. This display indicates a problem with L2, C1, and/or J1.

Cracked Solder Joints

The horizontal scan rate of the Macintosh 128K to SE is given as 22.25 kHz (kilohertz). In other words, 22,250 horizontal lines are swept every second. To understand the significance of that, it helps to convert the scan rate into something more familiar. The following question and answer exercise converts the horizontal scan rate into miles-per-hour:

1. *First, ask how long is each line?* Each line measures 7.11 inches, or dividing by 12 inches (per foot), there's .5925 feet per line.
2. *Next, ask how many feet per second?* .5925 feet per line \times 22,250 lines per second = 13,183.125 feet per second.
3. *Next, ask how many feet is that per minute?* 13,183.125 feet per second \times 60 seconds per minute = 790,987.50 feet per minute.
4. *Next, ask how many feet is that per hour?* 790,987.5 feet per minute \times 60 minutes per hour = 47,459,250 feet per hour.

5. *Finally, ask how many miles is that per hour? 47,459,250 feet per hour ÷ 5,280 feet per mile = 8,988.4943 miles per hour!*

22.25 kHz is nearly mach-12, almost twelve times the speed of sound! Since you can't see anything moving that fast, the display appears to be stationary. Nevertheless, it helps to think of it as a tiny paint brush, 1-pixel wide, continually in motion, sweeping from side to side, from top to bottom at twelve times the speed of sound. Wow!

The vertical scan rate is given as 60.15 Hz. It's much slower than the horizontal rate because there's only a one pixel drop for every 512 pixels across. In addition, the horizontal sweep zigzags another 28 lines on its way from the bottom of the screen back up to the top. So, the horizontal sweep really draws a total of 370 (342 + 28) lines across the screen, to every one line drawn up and down the screen by the vertical sweep. 22,250 lines per second ÷ 370 = 60.135. We lost .015 lines per second (60.15 - 60.135) somewhere, but essentially it works out. The vertical sweep is relatively slow. The horizontal sweep is very fast.

The speed factor explains why the vertical circuits are not prone to cracked solder joints. Compared to 22,250 Hz (high-frequency, soprano), 60 Hz (low-frequency, baritone) is nothing. Baritones can't crack glass, but 22.25 kHz can crack a solder joint just the way a soprano can crack crystal. So now that we know what causes this problem, (high-frequency vibrations) and now that we can imagine how easy it must be to fix (disconnect the power cord and resolder the crack), how is it that cracked joints are so often overlooked? Figures 5-3 to 5-4 tell the story.

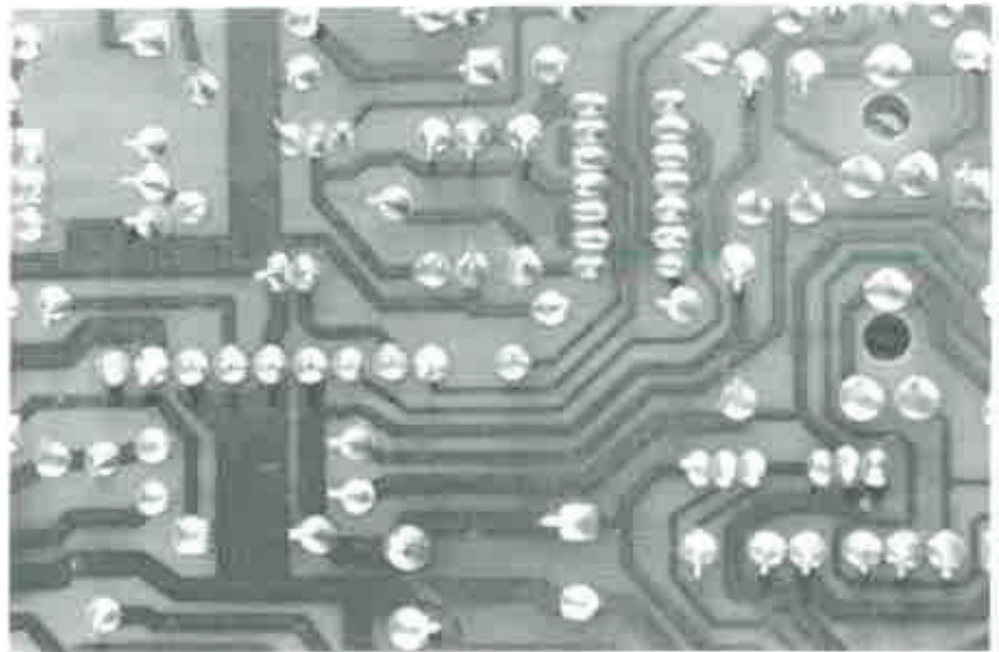

Figure 5-3 A cracked solder joint on the J1 connector.

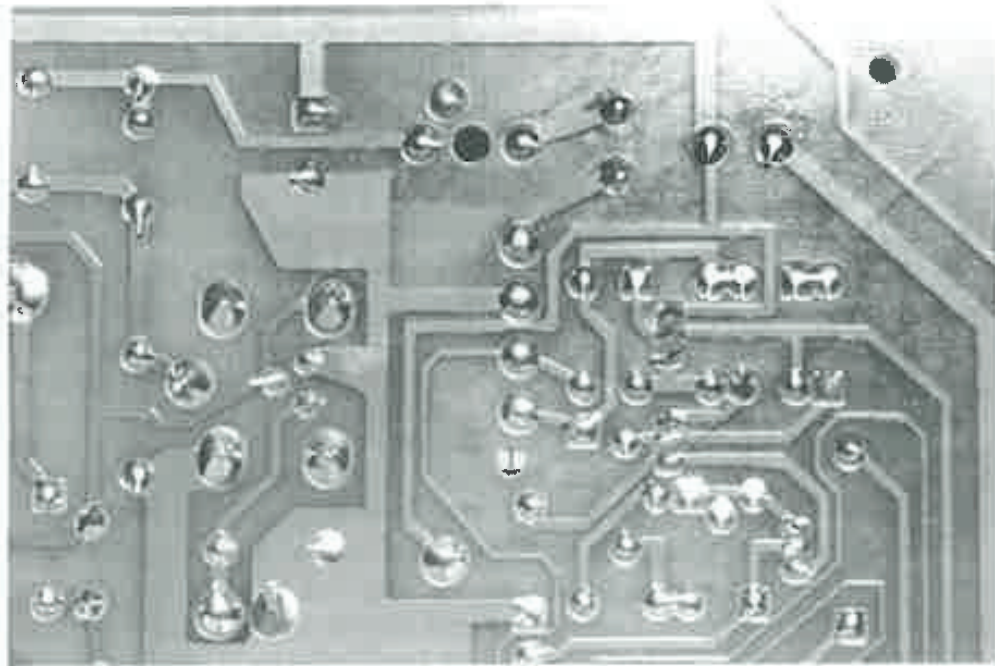

Figure 5-4 A cracked solder joint on the J4 connector.

Officially, the saying goes, “You can’t see the forest for the trees,” but in this case, it’s just the opposite. Take Figures 5-3 and 5-4. Most people looking at those pictures observe a sea of solder joints. They pick up on the board, the forest. They are overwhelmed by the big picture. They completely *overlook* the individual joints, which in this case are the trees. Study the trees carefully. The strong trees look like shiny gumdrops. The cracked trees look like tiny nipples. You’ll find the cracked trees exactly in the center of each photo.

Figure 5-3 shows the beginnings of a crack on pin-1 (composite video) of the J4 connector. J4 pin-1 goes to pin-8 of U2, the SN74LS38N synchronization IC (integrated circuit). Lose this connection and you’ll have problem 7, no raster, a completely dark screen. That’s not our problem right now, but if the crack isn’t fixed, it will be a problem very shortly.

Figure 5-4 tells the immediate story. There’s a huge crack on pin-4 of the J-1 connector. Looking at Figure 5-1, we see that pin-4 leads directly to the horizontal yoke. No wonder the display collapsed to a vertical line! The effect of a crack on pin-4 is the same as if you were to break the horizontal sweep circuit at the point between C1 and J1 in Figure 5-1. All we’ve got to do to restore the sweep is disconnect the power cord (from the wall outlet) and resolder the J1 connector. But wait, there’s a catch!

Remember the dire warnings concerning the vinyl jacket’s sticky pads given in Chapter 4? When we discussed the upper pad, we said that the area underneath (right over the J1 connector) was a major high-voltage trouble

spot. We also said that this area tends to overheat and that the upper sticky pad was the most difficult to remove. Well, if you don't remove it, you'll never even see the crack, much less fix it. To repeat what we said in the last chapter, all of the sticky stuff has to come off. Don't try to solder through it. The adhesive will contaminate the solder and you'll end up with a high-resistance connection.

The problem isn't always on the J1 connector. Sometimes, J1 is fine, but there's a crack at the base of C1 and/or L2. Sometimes, cracks, or the beginnings of cracks, are at the base of all three. Any cracks you see will have to be fixed. If you just opened to this chapter and you don't have any soldering experience, read Chapter 4 or refer to Chapter 11 for basic soldering information.

To keep the problem of cracked solder joints from recurring, you can apply a dampening material to the base of C1, J1, and L2. Even though you can't see C1, J1, and L2 moving, they're apparently picking up high-frequency vibrations. Only the signal should vibrate, not the parts. To keep the induced vibrations (circuit resonance) down, apply enough sealant to the bases of C1, J1, and L2, so that they're thoroughly cemented to the component side of the board. Bathroom, tub, and tile sealant works fine, but the preferred material is hot glue dispensed from a glue gun. Silicone sealant has a vinegar smell, the squeeze tubes tend to make a mess, and the material can take days to cure. Hot glue generally doesn't have an offensive smell, and it cures in minutes. Plus, it dispenses neatly and is easily removed, should that become necessary. Otherwise, both materials work fine. If you'd rather not deal with this problem ever again, seal the parts to the component side of the board!

C1 Failure

Sometimes, the display collapses to a vertical line and all the solder joints look fine. In that case, the next logical suspect is C1, the Mac's HF (high-frequency) 3.9-mfd NP (nonpolarized) horizontal deflection capacitor. The original OEM part used from the 128K through early Mac Plus models was rated 25 V DC, at 85°C (degrees Celsius). These tend to fail during heat waves. The new OEM part (late model Mac Plus to Mac SE) is rated 35 V DC, at 85°C. These dissipate heat a little better because they're larger, but they've also been known to fail in very hot weather.

Testing C1 In-Circuit If you look at the schematic relationship shown in Figure 5-1, you'll see that C1 is in series with the horizontal deflection circuit. Series caps are known as DC blocking caps. The operating voltage coming in on pins 3 and 4 of T1 is DC. The sweep signal passing through the circuit is high-frequency AC. C1's function is to keep the operating voltage (DC) from interfering with the sweep signal (AC). Because C1 is passing AC and blocking DC, testing it with a high-impedance (10,000,000 ohms per volt) multimeter is tricky. Complex waveforms are overlapped. Which of the waveforms will the meter see, AC or DC? It all depends on the meter. FET

(field effect transistor) meters tend to read 0 V on both the AC and the DC scales. High-frequency digital meters tend to read 0 V on the DC scale and 65 V to 80 V on the AC scale. Other digital meters may give other results. None of them will be correct. The only way to test C1 accurately is to increase the impedance of your test instrument to 20,000,000 ohms per volt. Since typical multimeters are already 10,000,000 ohms per volt, all you need to do is put an extra 10-meg (megohm) resistor in series with the existing red probe. Resistors in a series circuit add up the same way you add up pocket change. Officially, the formula is $R_t (\text{Total}) = R_1 + R_2 + R_3$, etc. In our case, 10,000,000 existing ohms + 10,000,000 additional ohms = 20,000,000 total ohms per volt.

Another way to double the input impedance of a multimeter is to use a DC×2 probe. Some meters come with these as standard equipment. Generally, DC×2 probes are similar to the custom CRT discharge tool described in Chapter 1, except they terminate in a banana plug instead of an alligator clip. Assuming you have a 10,000,000 ohm per volt multimeter, you can even use the 10-meg discharge tool to make your own DC×2 probe. Just clip one end of the 10-meg tool to your existing 10-meg (DC×1) probe and use the business end as a DC×2 probe. If you recall from Chapter 1, the recommended CRT discharge tool was nothing more than an insulated test probe with a 10-meg resistor in the barrel. 10 megs + 10 megs = 20 megs. For what we want to do right now, it's perfect!

With the extra 10 megs in series with the red probe, all DC scales will be doubled. So, if you're using a FET meter on the 15-V scale, remember to think 30-V scale. On a digital meter, you have to double the readout. If it reads 15 V, remember that the actual measurement is 30 V. Here's the complete in-circuit test procedure:

1. Set up a DC×2 probe as described above, turn on the meter, and set it to read DC volts. Clip the black lead to the chassis.
2. Face the solder side of the board, and turn on the set. It's not necessary to boot up.
3. Touch the red DC×2 lead to each of C1's solder joints one at a time. Observe the readings. A good cap will read 18 V to 21 V (9×2 to 10.5×2) at the top joint and -14 mV to -100 mV (-7×2 to -50×2) at the bottom joint. Readings within this range indicate that the cap is, in fact, blocking DC. The top reading shows the DC voltage going into the cap; the bottom reading shows virtually no DC getting out. Obviously, the closer the bottom reading is to 0 V, the better the cap. As mentioned in the previous chapter, the negative millivolt reading indicates leakage. Anything beyond 100 mV indicates the cap should be changed. Readings in that area suggest total failure is imminent.

Testing C1 Out-of-Circuit If you don't have a 10-meg resistor, you can test C1 out-of-circuit using an inexpensive pocket VOM. Here's the complete out-of-circuit test procedure:

1. Desolder C1 and remove it from the analog board.
2. Turn on your analog multimeter and set it to the R \times 10K scale.
3. Short-circuit the capacitor by touching one of the meter probes (or any piece of bare metal), across the desoldered leads. If this were a new part with untrimmed (long) leads, all you'd have to do is touch the leads together.
4. Clip the black test probe to one lead. Get ready to touch the red probe to the other lead. Watch the meter. Touch the red probe to the lead. The pointer should momentarily drop to 12.5 (125,000 ohms) then return to infinity.
5. Unclip the black probe and clip it to the opposite lead. Get ready to touch the red probe to the other lead. Watch the meter. Make the connection. This time the pointer should momentarily drop to 2.5 (25,000 ohms) before returning to infinity.

Bad capacitors generally read 12.5 to 25 in both directions. Generally, they don't drop all the way to 2.5. Since these dips are only momentary, you have to be watching the meter when you connect the red probe. You can't look away, because you'll miss the reading. If that happens, just repeat steps 3 through 5 to retest the cap.

Sometimes, you can also test C1 in-circuit using a pocket VOM. If the frequency response of the meter is low enough, it might not see the sweep signal. In that case, it'll only respond to the DC operating voltage, and you might get an accurate 18- to 21-V DC input reading at the top (input side) of the cap. The only problem is that it might be difficult to read DC millivolts on the output side. When the lowest available V DC range is 0 to 15 V, -100 mV barely moves the pointer.

Remember, it's not necessary to test C1. All you really need to know is that as long as the set is already apart, 25-V OEM caps ought to be replaced. Many shops do it as a matter of course when they upgrade and repair Macs, because it increases reliability in extremely hot weather. Given that the Mac is already apart, have it done! All we're talking about is a couple of dollars and an extra two minutes of work.

Replacing C1 When choosing a replacement for C1, bear in mind that this is a relatively large size, high-frequency (HF), nonpolarized (NP) capacitor. Relatively small size, bipolar (BP) capacitors, the kind used for loudspeaker crossovers and audio filters, won't work in this circuit. Earlier in this chapter, we learned that the horizontal oscillator frequency (22.25 kHz) is 12 times the speed of sound. If the replacement C1 can't switch at that speed, its capacitance drops. Instead of passing the signal, it begins to oppose the signal. The charge doesn't clear, the cap heats up, and in most cases, it explodes like a 4th of July firecracker. Not only is that potentially harmful to the set, but it can result in serious personal injury. For safety's sake, don't experiment with crossover caps. Use one of the replacements listed in Table 5-3.

Table 5-3 Acceptable Replacements for C1

Cap	WV	WTemp	Type	OEM
3.9 mfd	100 V	85 °C	HF NP AL radial	Nichicon
4.0 mfd	25 V	85 °C	HF NP AL axial	Nichicon
3.9 mfd	250 V	85 °C	HF Metallized polypropylene	Nichicon
3.9 mfd	250 V	85 °C	Metallized polyester	Nichicon
3.9 mfd	100 V	85 °C	Metallized polyester	Panasonic

If none of these are available, the physical size of a replacement capacitor is a good indicator of whether or not it's going to work in the C1 application. For example, the 25-V cap on the left of Figure 5-5 is an OEM part removed from a stock Mac Plus. The large 100-V cap in the middle is a better-than-OEM replacement. The tiny 100-V cap on the right is a firecracker waiting to explode. It's completely unsuitable, even though its ratings (4 mfd 100 V) suggest that it might be OK. Use common sense. Don't rely on ratings!

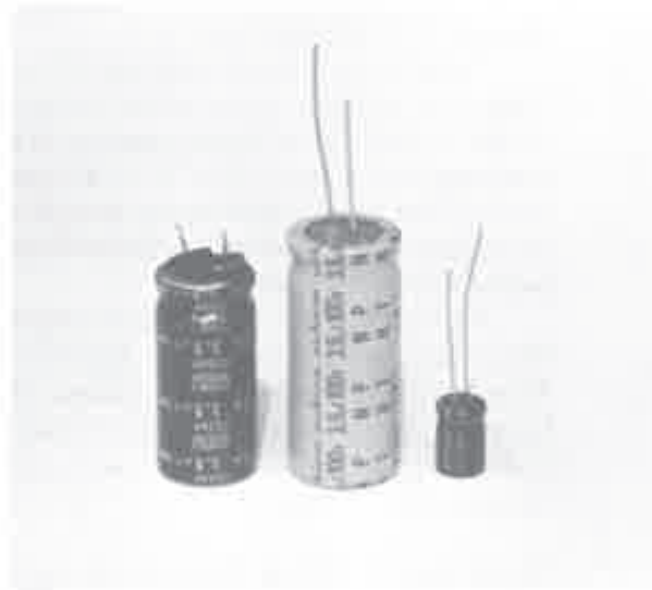

Figure 5-5 Physical size is a good indicator of whether or not the replacement capacitor is going to work. The little nonpolar cap on the right is completely unsuitable, even though its ratings (4 mfd 100 V) suggest that it might be OK.

In every case (128K to Mac SE), the large 100-V HF NP AL radial Nichicon listed at the top of Table 5-3 is the preferred replacement. As shown in Figure 5-6, the 100-V Nichicon fits fine; it goes in just as easily as the OEM

cap, and it looks like it belongs in there. At the same time, because it's substantially larger than either of the OEM caps, it dissipates heat *much* better. These 100-V replacements have repeatedly withstood the torture test. They are not known to fail during summer heat waves! Your Mac may still go down under those conditions, but it's not going to be C1 that causes it.

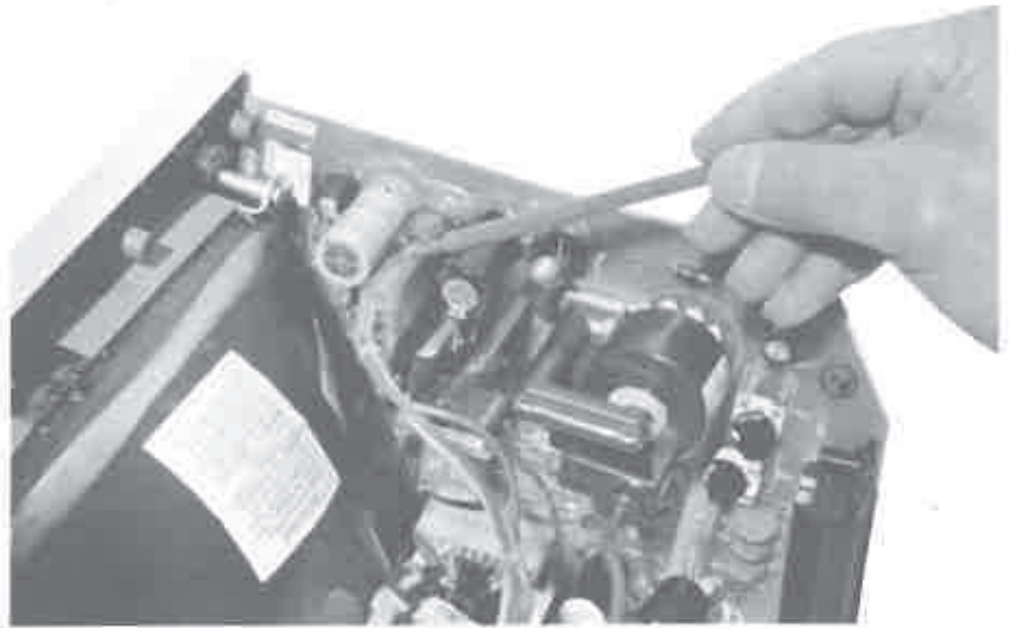

Figure 5-6 The large 100-V Nichicon fits fine and looks like it belongs there.

Electrically, the second cap on the list, the 25-V HF NP AL axial Nichicon can be considered an exact replacement for the original OEM cap. No 25-V HF cap will be as good as a 100-V HF cap, but this particular part is blister-packed, and you might find one right on the rack at your local independent electronics store. Since it's an axial (leads out the side) model, you have to bend one lead and sleeve it with insulating tubing in order to install it. That's common practice in the Radio/TV repair business. The usual sleeving and bending method is illustrated in Figure 5-7.

The next two caps on the list, the 250-V Nichicons, work extremely well but are extremely difficult to come by. A similar style cap, the 100-V metallized polyester Panasonic, is shown in Figure 5-8.

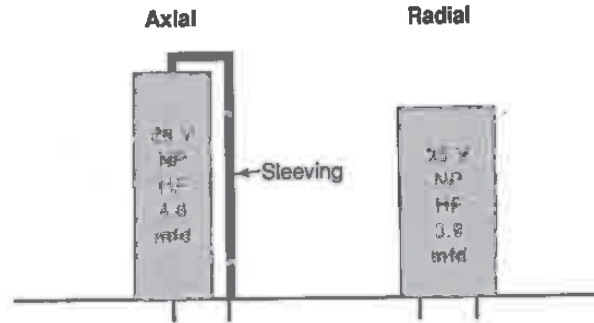

Figure 5-7 Axial caps have leads out the side. Radial caps have leads out the bottom. To use an axial cap in a radial application, all you have to do is bend and sleeve one lead.

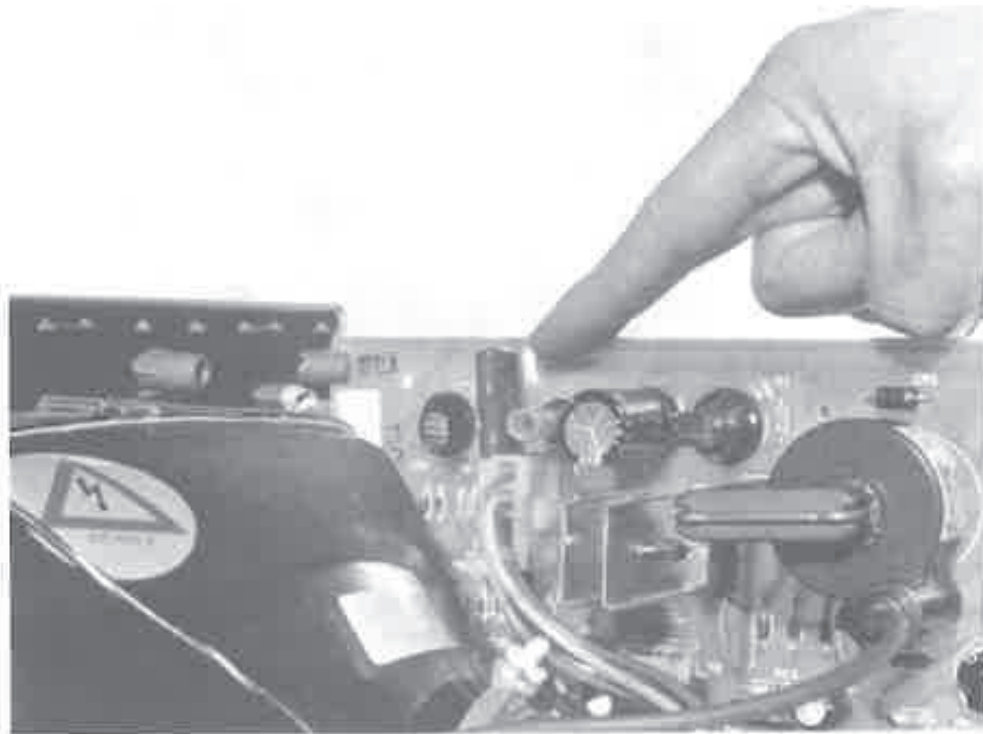

Figure 5-8 3.9-mfd 100-V metallized-polyester caps can also be used.

To use any of the metal poly caps, you have to bend the leads as shown in Figure 5-9. Make sure the top side of the cap is no higher than the top of the circuit board, before you solder it in place. If the top side sticks up even the least little bit, you may not be able to get the cover back on!

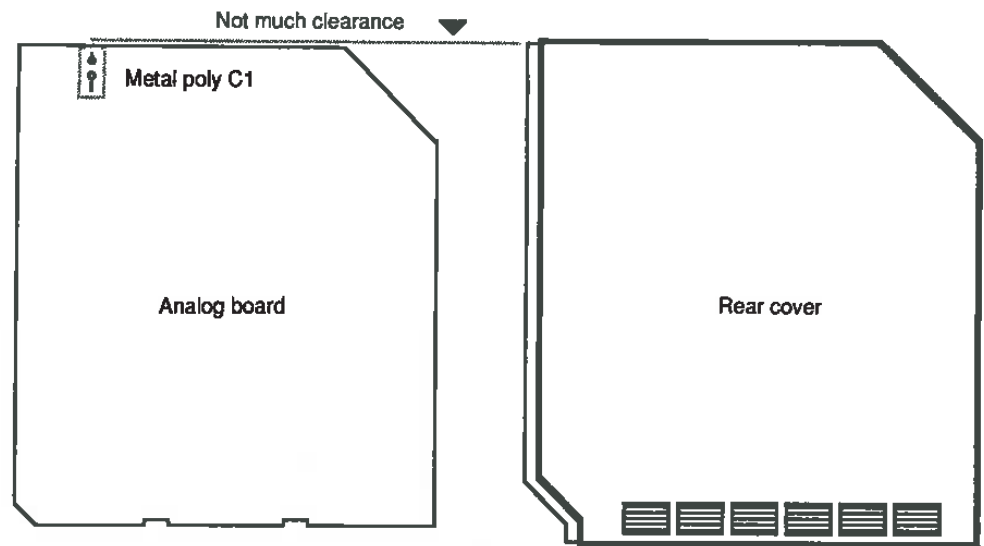

Figure 5-9 When installing a metal poly replacement cap, keep the top level with the circuit board, or you may not be able to get the cover back on!

Jitters, Ringing, Ozone Smell, Worms in the Display

When there are wavy lines running through the display, if the set makes a ringing noise, or if it makes an ozone (car exhaust/smog) smell, it generally means you're about to lose the flyback transformer, board reference T1. The function of the flyback transformer is to convert low voltage (12 V) into the high voltage (13 kV) needed to drive the CRT. When the flyback fails completely (shorts-out), high current is drawn. Inside a computer, high current tends to burn things. The above symptoms (wiggles, ringing noises, ozone smells) generally mean **DISASTER IS IMMINENT!** There could be massive circuit board damage (affecting Q3, INTERNATIONAL Q2, T1, C1, J1, and L2 as detailed under problems 5 and 6) if you don't shut down immediately.

Identifying the Flyback Transformer

As shown in Figures 5-6 and 5-8, the flyback transformer is located at the top of the analog board, four components to the right of C1. This part has gone through three major revisions. By observing the make, model number, and color of the transformer, you can determine the age and origin of the analog board. Throughout the following discussion, refer to Figure 5-10.



Figure 5-10 Flyback transformer types. The black transformer at the left came from an original 128K Mac. The gray and white transformer in the middle came from an early model Mac Plus. The solid gray transformer at the right is the latest, UL listed Macintosh SE type.

Black flybacks, marked “ZFAT-AC 508,” or “Taiwan Totoku Electric Co.-157-0026-B” are an early type. These indicate an original 128K Macintosh or an early model 512K. Gray flybacks, marked “Tai-Ho/Taiwan R.O.C.-TH-1565,” or “Monitron/Taiwan R.O.C.-157-0026-B” indicate a late model 512K, a 512Ke, or an early model Mac Plus. Gray flybacks marked “Monitron/Taiwan R.O.C.-157-0026-C,” or “Tai-Ho/Taiwan R.O.C.-TH-1565C” indicate a late model Mac Plus or a Macintosh SE. The relationship between the various part numbers and the origin of the analog board is summarized in Table 5-4.

Sometimes you’ll find an SE-style flyback transformer in an older machine. That indicates a previous repair. Other times, you’ll find an old style flyback transformer in a machine that appears to be a Mac Plus. That could happen if:

1. The machine was originally a 128K or 512K Mac which was *partially* upgraded to a Mac Plus.
2. The original Mac Plus analog board failed and was swapped out for an earlier 128K to 512K version.

Table 5-4 Identifying an Analog Board by OEM Flyback Type

Original Equipment Mfg.	Part Number	Indicates
ZFAT	AC-058	128K or early 512K
Taiwan Totoku Electric Co.	157-0026-B	128K or early 512K
Tai-Ho/Taiwan R.O.C.	TH-1565	Late 512K, 512Ke or Plus
Monitron/Taiwan R.O.C.	157-0026-B	Mid-model Mac Plus
Tai-Ho/Taiwan R.O.C.	TH-1565C	Mac SE
Monitron/Taiwan R.O.C.	157-0026-C	Late-model Mac Plus
Lifon/Taiwan R.O.C.	157-0042-B	Mac SE or repaired board

In either case, the important point is that 128K to 512K computers which have received a Mac Plus logic board upgrade, or an analog board swap, are *just* that. They are not the same as an official Mac Plus, because they still have an old (less reliable) version of the analog board. To complete the upgrade, whenever you replace the flyback on one of these “half-and-half” computers, you should at least change C1 and CR21 as well and probably a few other parts. Further details on the power supply upgrade are given in Chapter 7.

Identifying a Bad Flyback Transformer

If you catch the jittering, the ringing, or the smell early enough, there may be no visible indication that the flyback is about to fail. As shown in Figures 4-18 and 5-11, bubbled labels look ominous, but actually mean nothing. Bubbled labels are normal.



Figure 5-11 Bubbled labels look ominous, but actually mean nothing.

If there's a ringing noise, the epoxy seals at the top and bottom of the transformer may be broken. This symptom is shown in Figure 5-12. You might have some success regluing the seals, but generally, because the potential for circuit board damage is so great while the cost of a replacement transformer is so small, it's not recommended.

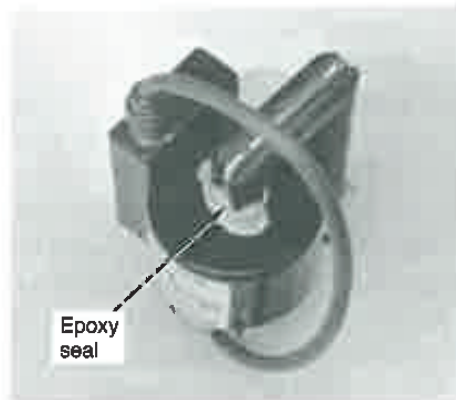

Figure 5-12 In the case of ringing, the epoxy seals at the top and bottom of the transformer may be broken.

In the advanced stages of failure, the case of the flyback may show an obvious deformity. Two good examples of this are shown in Figure 5-13. Neither the bubble, nor the stripe are supposed to be there!



Figure 5-13 In advanced stages of failure, the case may show an obvious deformity.

Sometimes, there's no evidence of failure whatsoever, until you physically remove the transformer. Then, as shown in Figure 5-14, you might see evidence of burning on pin-4.



Figure 5-14 Usually there's evidence of burning on pin-4.

In the case of ozone smell, the resin underneath the transformer may bubble as shown in Figure 5-15. Unlike the stick-on label, this kind of bubbling is serious!

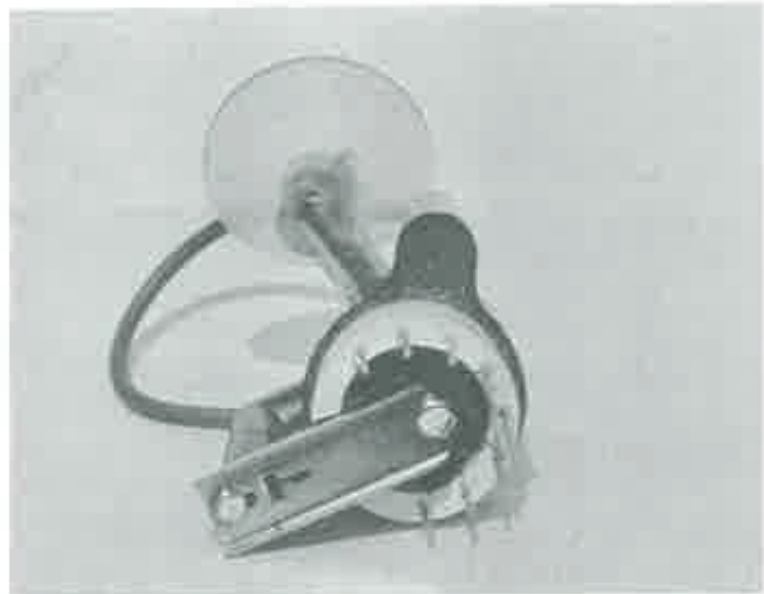

Figure 5-15 In the case of ozone smell, the resin underneath the transformer may bubble.

Other times, you know the flyback is bad because the circuit board is burned in the area of Q3. If Q3 is bad, you can bet a shorted flyback caused it. We'll have more to say about that when we get into problems 5 and 6, covering severe distortion, burning smells, and smoke.

Replacing the Flyback Transformer

Replacing the flyback transformer looks and sounds like a big job, but it actually involves just a few basic steps:

1. First, make sure the set is switched off and that the power cord is physically disconnected from the wall outlet. Make absolutely sure!
2. Discharge the CRT through a 10-meg resistor as instructed in Chapter 1. If you fail to use the resistor, or if you try to do this with the power cord connected, you may be surprised by a big spark. If so, after you replace the flyback, you may have two new problems to deal with, a blown LAG chip on the logic board, and a blown 74LS38N (U2) on the analog board. That's costly!
3. When the CRT is fully discharged (when there's no more soft crackling), free the anode connector from the anode well. As illustrated in Figure 5-16, the metal prongs under the suction cup resemble a winged, uppercase "V." Push in on the center of the V with the tip of the discharge probe to unhook the first wing. When the first wing is free, the other wing should slip right out.

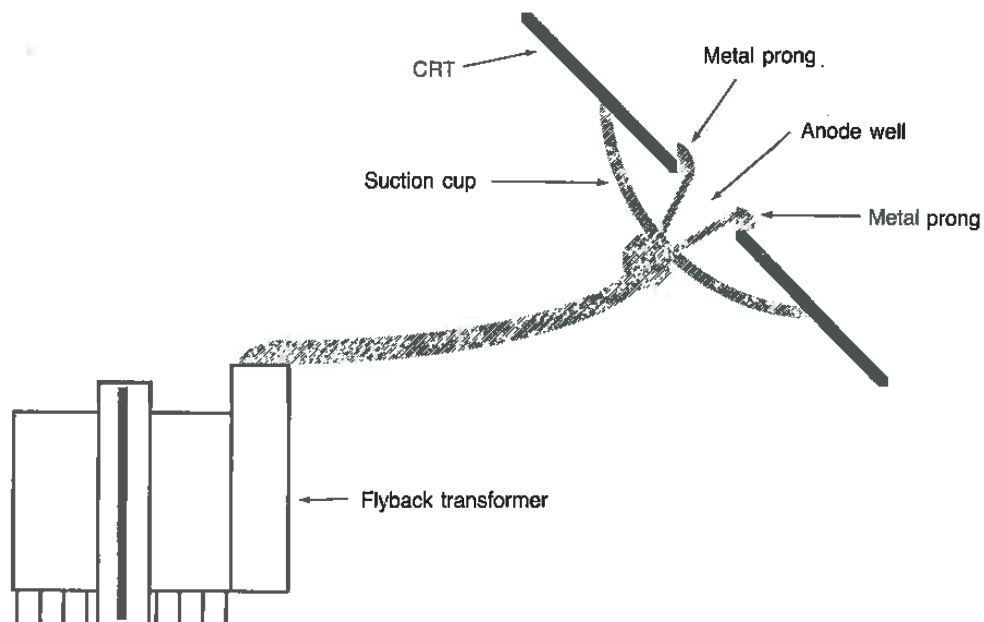

Figure 5-16 The metal prongs under the suction cup resemble a winged, uppercase "V."

4. Lay the Macintosh on its side, so that the solder side of the analog board is facing up. Desolder the flyback transformer according to the general desoldering instructions given in Chapters 4 and/or 11. Even though 9 joints are involved, none of the transformer pins is bent over. That means you can center the desoldering tool right over each pin, which makes it very easy to remove the old solder. When you get to the last pin, you'll need an extra hand (or a coffee can) to support the old part. Otherwise it'll fall out when you heat the joint, and it may hit the CRT on the way down.
5. Reverse steps 4 through 1 to install the new part.

This is a lot easier than it looks. My personal record on a flyback replacement (old one out—new one in) is just under two minutes. You need the right tools, of course, and some desoldering experience, but given that, there's really nothing to it.

Before switching on the set, read through the next few sections. You may have a problem with Q3 (Q2 on the International analog board.) If that's the case, you'll have to take care of it *before* applying power, or you'll just burn out the new flyback.

Severe Distortion—Wavy Lines, Display Getting Darker

If you've got severe display distortion, wavy lines, if everything is getting darker and darker, T1 has shorted, and high current is being drawn through Q3 (INTERNATIONAL Q2). In that case, Q3 will have to be changed along with T1, even if by some miracle, Q3 still tests good. But if you only had jittering, ringing, or ozone smell (no severe distortion), Q3 will probably be OK. Whether or not you have to change Q3 depends on how soon you detect the flyback problem. As shown in Figures 5-5 and 5-7, Q3 is located at the top of the analog board, two components to the right of C1 and one component down. It's a TO-220, generic BU-406 power transistor (7 amperes, NPN silicon, 60 watts) attached to a large heat sink. If the circuit board underneath the heat sink is burned, or if the heat sink has turned reddish blue as shown in Figure 5-17, don't waste time with the following test procedure. Either sign is positive proof that the Q3 will have to be changed.

157-0042C
LIFON

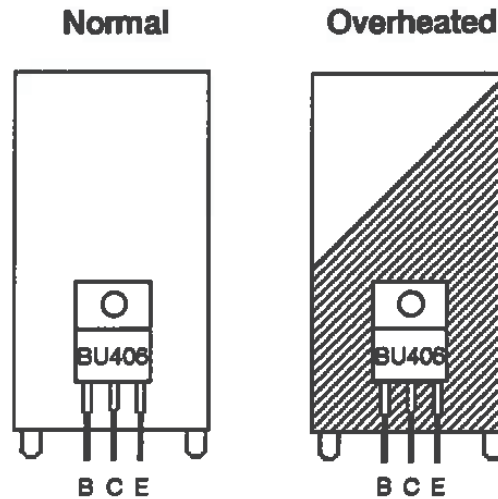

Figure 5-17 Reddish blue metal is a sure sign of overheating.

Testing Q3 (INTERNATIONAL Q2) Out-of-Circuit

Usually Q3 goes down as the result of flyback failure. At that point, so much current is being drawn that it's not safe to make an in-circuit test. Even if you replace the flyback, you still can't power up without testing Q3, because if it's shorted, it might ruin the new transformer. Assuming you've had a flyback problem, the only safe way to test Q3 is to physically remove it from the analog board. Here's the complete, out-of-circuit test procedure:

1. Lay the Macintosh on its side so that the solder side of the analog board is facing up. Desolder the three transistor leads according to the general desoldering instructions given in Chapters 4 and/or 11.
2. Desolder the heat sink tabs. Note that they have a 45-degree twist in them. Once you've cleared the solder and broken the tabs free, straighten out the twists with a pair of pliers. When you've got them perfectly straight, the desoldered tabs should slip easily through the holes in the analog board. Don't try to force partially desoldered, twisted tabs through the openings. The twist locks the heat sink in place, underneath the board. If you try to force the tabs through, you'll just damage the traces. Straighten the twists. It only takes two seconds!
3. Turn on your multimeter and set it to the R \times 100 scale. Refer to Figure 5-17 and Tables 5-5 to 5-6 to test the part.

Table 5-5 Good Q3 (INTERNATIONAL Q2) Test Results

Junction	Red/Black	Black/Red
Emitter/collector	Infinity	Infinity
Base/emitter	650 Ω	Infinity
Base/collector	650 Ω	Infinity

Table 5-6 Bad Q3 (INTERNATIONAL Q2) Test Results

Junction	Red/Black	Black/Red
Emitter/collector	650 Ω	Infinity
Base/emitter	150 Ω	150 Ω
Base/collector	650 Ω	Infinity

Q3's emitter, base, and collector junctions are identified in Figure 5-15. To make the first emitter to collector test, clip the red lead to the emitter and the black lead to the collector. If the transistor is good, you'll read infinity as shown in Table 5-5. If it's bad, you'll read 650 Ω as shown in Table 5-6. Now reverse the leads. Clip the black lead to the emitter and the red lead to the collector. You should read infinity whether the transistor is good or bad.

To make the first base-to-emitter test, clip the red lead to the base and clip the black lead to the emitter. If the transistor is good, you'll read 650 Ω as shown in Table 5-5. If it's bad, you'll read 150 Ω as shown in Table 5-6. Now reverse the leads. Clip the black lead to the base and the red lead to the emitter. You should read infinity if the transistor is good or 150 Ω if the transistor is bad.

A good BU-406 transistor will always test according to Table 5-5. A bad BU-406 transistor won't necessarily test according to Table 5-6, but the readings given are fairly consistent for this application.

Replacing Q3 (INTERNATIONAL Q2)

If you're lucky, Q3 will be bolted to the heat sink. If that's the case, you can remove it with a pair of pliers and a small screwdriver. More often than not, however, it's been pop-riveted which means you have to drill out the rivet. Use a power drill with an 1/8-inch bit, and secure the heat sink in a vise to keep it from spinning. Whatever you do, don't discard the old heat sink! Replacements are hard to come by. Unless you're up to fabricating a new one, the originals have to be recycled.

Underneath the transistor, you should notice a small amount of sticky white compound. That's heat sink grease. It's there to fill imperfections (air

pockets) in the metal, which increases the thermal transfer between the transistor's mounting tab and the metal heat sink. The thermal resistance of air trapped in scratches and tiny imperfections is said to be 1200 degrees Celsius-inches per watt ($^{\circ}\text{C-in/W}$). The thermal resistance of heat sink compounds used to fill those imperfections is said to be 60 $^{\circ}\text{C-in/W}$. I've never measured either one, but since $1200/60 = 20$, nicks, scratches, and other imperfections in the metal are said to have a thermal resistance of only $1/20$ of the original value after they've been filled with compound. The math works out. Most technicians take the rest of it on faith. It's standard procedure to apply heat sink compound whenever you mount a power transistor.

If the heat sink metal appears reddish blue as illustrated in Figure 5-17, shine it on a wire wheel, or use some metal polish on it. You want the surface of the heat sink to be as smooth and shiny as possible. That way, the new heat sink grease won't have to work as hard. Also, you don't want to give a false impression to the next owner. If someone looks in there later and sees a reddish blue heat sink, the person's going to suspect that Q3 has failed again, when in fact, you never cleaned up from the last time.

Wherever possible, use an exact replacement BU-406 transistor rather than a substitute. Substitutes can cost twice as much, and unlike C1 substitutes, they may not work as well. One popular brand causes severe horizontal foldover along the left edge of the screen. You can go around and around and never fix the foldover problem, because the fix is the problem. If you need to replace Q3 in a hurry, and you can't find a generic BU-406 locally, check the appendix for acceptable replacement information. Just remember that if you get foldover, the cause is most likely the substitute transistor and not some other problem.

When you're ready to put everything back together, apply a fresh dab of thermal compound to the transistor and attach it to the heat sink with a $6/32 \times 1/4$ inch machine screw and a matching $6/32$ nut. Remember to grip the screwdriver loosely between your thumb and index finger. Don't overtighten! As soon as you start to see a little grease squeeze out from under the transistor mounting tab, stop. If you continue to bear down, you'll just bend the tab, allowing air to come between the heat sink and the transistor. That's counterproductive.

Set Makes a Burning Smell/Smokes

If the set makes a burning smell or if smoke rises from the top, C1 may have shorted out and burned the board under J1 and L2. Either or both of these parts may have melted. Figure 5-18 shows samples of badly burned J1 connectors. Note that the damage is always on pin-4, the horizontal sweep connection in series with C1. If you're still wondering whether it's worth upgrading to a 100-V capacitor, study that picture very carefully.

Always inspect pin-4 for damage. Even slightly overheated J1's have to be replaced. Once the plating is burned off of pin-4, it'll never make good

contact, no matter what you do. Your Mac will always be like a flashlight that once had leaky batteries. Every time you power up, you'll have to slap the left side of the set just to get the horizontal sweep working.

Slightly burned L2's are a different story. Cosmetic damage is irrelevant, provided the slug can be freed with a metal hex tool as described in Chapter 3. Otherwise, L2 will also have to be replaced. In that case, don't settle for OEM quality. Order one made with LITZ wire. These cost a few bucks, but they dissipate heat better and offer less resistance to the sweep signal.



Figure 5-18 Burned J1 connectors. Note that the damage is always on pin-4, the horizontal sweep connection in series with C1.

Another cause of burning smells and smoke rising from the top is Q3. If someone watches the severe display distortion long enough, or if they're unlucky enough to walk away from the computer and have it fail in their absence, the high current drawn when Q3 shorts will burn the circuit board.

All of these problems look and smell terrible, but don't be discouraged by them. The cost of replacement parts is nickels and dimes next to the cost of a whole new analog board. With new parts, especially if you use the heavy-duty parts recommended in Chapter 7, the repaired analog board will work better than ever. There's no need to trade it just because a couple of parts smoked. Honest!

No Raster, Completely Dark

If the set bongs on startup but there's no raster, check for cracked solder joints on pin-1 and pin-3 of the J4 connector. If that's not the problem, check the

white and orange wires of the analog board to logic board cable for continuity. Table 5-7 gives the color code and function of each of the wires.

Table 5-7 Color Codes—J4 to Logic Board Cable

J4-pin	Color	Function
1	White	Composite video
2	N/A	Key
3	Orange	Horizontal synch.
4	Yellow	Internal speaker
5	Green	Vertical synch.
6	Blue	+5.00 V DC
7	Violet	Ground
8	Red	-12.00 V DC
9	Orange	Ground
10	Yellow	+12.00 V DC
11	Green	+4.5-V battery

While the harness is out, check for tarnished pins inside the J4 and J7 connectors. Sometimes you don't find anything wrong, but after you disconnect and reconnect the harness, everything works again. What that suggests is a high resistance connection similar to the fluctuating +5.00-V problem described in Chapter 4. The only permanent way to fix this is to replace the harness and treat the connector pins inside J4 and J7 with stabilant. This material is a lot like heat sink grease in that it fills voids and imperfections in the metal. It's used to retard corrosion and lower electrical resistance. You'll be amazed at how well the stuff works. Refer to Chapter 4 for more information.

If everything in that area checks OK, both the LAG chip on the logic board and U2, the SN74LS38N IC on the analog board, may be bad. These chips often blow in tandem when you discharge the CRT without using a 10-meg bleeder resistor. If you did that, and you got an exceptionally big spark, you probably blew the chips. Now, you've got problems on both boards. If you replace the LAG but not U2, you'll momentarily see a vertical line, then the display will collapse to nothing. If you replace U2, but not the LAG, you'll get an overly bright raster but no blinking floppy disk icon. If you have a spare set of boards (from another Mac) you can try swapping boards to see whether or not your symptoms match those just given. Swapping the logic board essentially gives you a new LAG. If you see a momentary white line with the new logic board, then nothing, you know the LAG on the original logic board is bad. Swapping the analog board but not the suspect logic board essentially gives you a new U2 (SN74LS38N). Now you should get an overly bright raster but no blinking floppy disk icon. The solution is to install two new

chips, a new LAG on the logic board, and a new SN74LS38N on the analog board. For details on how to replace chips, refer to Chapter 10.

Display Collapses to a Horizontal Line

When the display collapses to a horizontal line, it means you lost the vertical sweep. Check for a cracked solder joint on pin-5 of the J4 connector. If that's not the problem, refer to Table 5-7 and check the green, vertical-synch. wire of the analog board to logic board cable for continuity. If the green wire checks OK, you may have a problem on the analog board in the area of Q1 and Q2 (INTERNATIONAL Q4). If the bottom half of the display disappears while the half above the horizontal line appears crunched, R3 may have opened. This symptom is illustrated in Figure 5-19.

If the top half of the display disappears while the half below the white line appears crunched, R2 may have opened. This symptom is illustrated in Figure 5-20. For reference, the schematic relationship between R2, R3, Q1, and Q2 (INTERNATIONAL Q4) is shown in Figure 5-21. Note that R2 and R3 are both $\frac{1}{4}$ -W 1.5- Ω resistors. When you put your ohmmeter across the leads in-circuit, you should read almost a dead short. If the meter reads infinity or shows an overrange condition, the resistors are bad. Usually they're burned open, like the resistors in the focus circuit. The tricky thing about R2 and R3 is that they never look burned. They look fine, but assuming you've got a vertical problem, they often test bad. In the next chapter, we'll talk about what causes open resistors and suggest two ways to keep it from happening again.

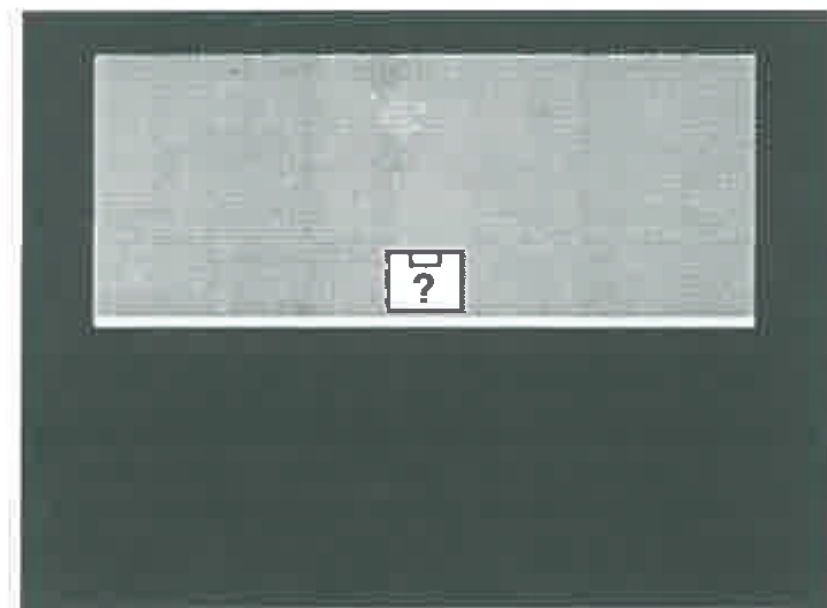

Figure 5-19 This display indicates a problem with R3 and/or Q1.

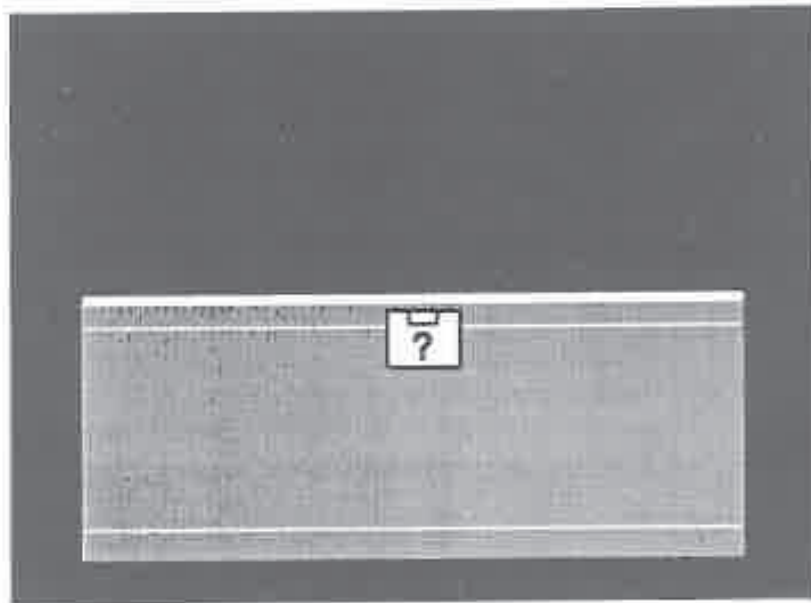

Figure 5-20 This display indicates a problem with R2 and/or Q2.

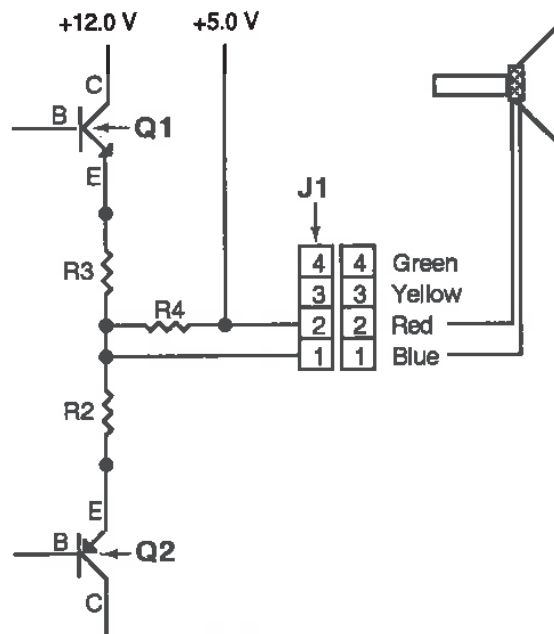

Figure 5-21 The schematic relationship between Q1, Q2 (International Q4), R2, and R3.

Display Collapses to a Pinprick

When the display collapses to a pinprick as shown in Figure 5-22, it means you lost both sweeps. Nothing is pulling the beam, so it just sits there, one pixel wide in the middle of the screen. What could have caused both sweeps to fail? Usually, this symptom means you had the power supply out and you forgot to reconnect the CRT yoke cable when you reinstalled it. If you work on enough sets, sooner or later it happens. Shut down, plug the yoke cable back into the J1 connector, and everything will be OK. If only all repairs were this easy!

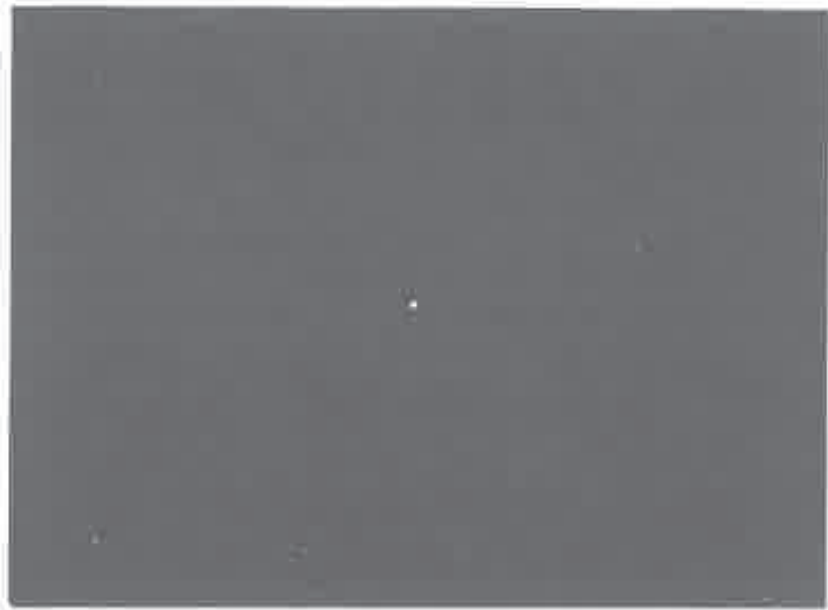

Figure 5-22 No horizontal sweep. No vertical sweep. This display suggests that the CRT to J1 cable is disconnected.

Summary

Intermittent video problems are usually the result of cracked solder joints at the bottom of C1, J1, J4, and/or L2. To repair these problems all you have to do is remove the power cord, locate the bad joint, and resolder it.

Sustained video problems are usually associated with the T1, the flyback transformer and/or C1, the horizontal deflection capacitor. When T1 fails, Q3 may be damaged. When C1 fails, J1 and L2 may be damaged.

Occasionally, R2 and/or R3 may fail, causing a vertical problem, but these failures are less common than the others.

Up to this point, we've dealt strictly with interactive repairs and visually confirmable failures. The set always started up for us. The display always suggested what the problem was. In the next chapter we'll look at sets that don't start up normally. We'll learn what to do about "flipping" sets, and we'll learn what to do when the set won't turn on.

CHAPTER

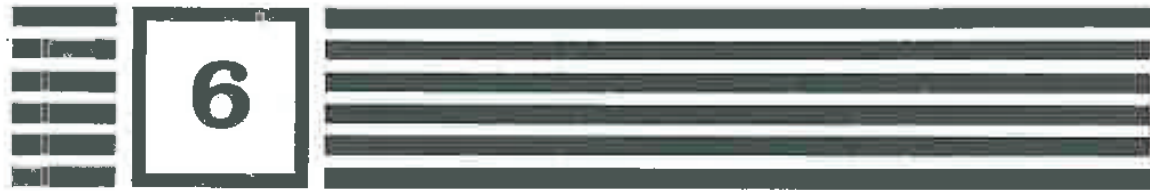

Dead Sets

When you're sure the computer is plugged in, and there's no response to the power switch, or if you hear a flup, flup, flup, noise when you switch on the power, it usually means trouble with one or more (usually several) of the following parts:



Display Symptom	Solution
1. Dead set (video area OK)	Test Q11 (INTERNATIONAL Q10) Test R52 (INTERNATIONAL R55) Test Q8, CR21 Test SW1, line cord, AC outlet
2. Dead set (video area burned)	Replace C1, T1 Inspect/replace J1, L2 Replace Q3 (INTERNATIONAL Q2) Test R46-51 (INTERNATIONAL R48-55) Test Q9-10 (INTERNATIONAL Q11-12)
3. Flipping set (logic board OK)	Check the analog to logic board cable connections. Check R56 (INTERNATIONAL R59) +5 V Inspect/replace C3,24-26,29-31 (INTERNATIONAL C3,24,27-28,30-32) Test/replace CR1, CR5, CR20-21 Test Q8, 2N6394 "crowbar" SCR
4. Flipping set (analog board OK)	Check the analog to logic board cable connections. Replace TSM chip on logic board Test 7908 regulator on logic board

For use with this chapter, Figure 6-1 shows the suspect parts as viewed through the solder side of an illuminated U.S. analog board. Figure 6-2 shows their schematic relationship.

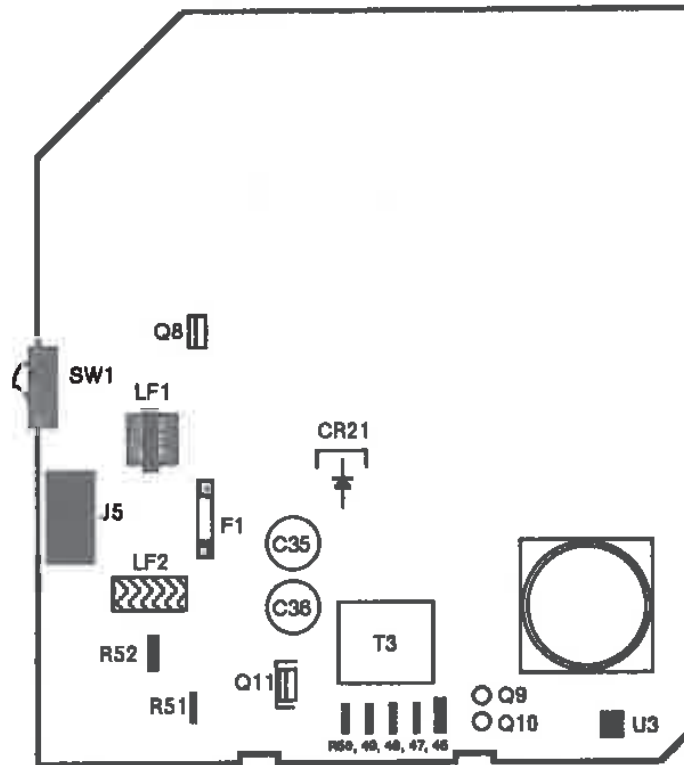

Figure 6-1 The suspect parts as viewed through the solder side of an illuminated U.S. analog board.

Isolating these problems requires more detective work than we've used up to now. Both boards are involved. The suspect list is longer, and any one (or any combination) of the suspects on either board could be responsible. Nevertheless, there are weapons at our disposal. The first is visual inspection.

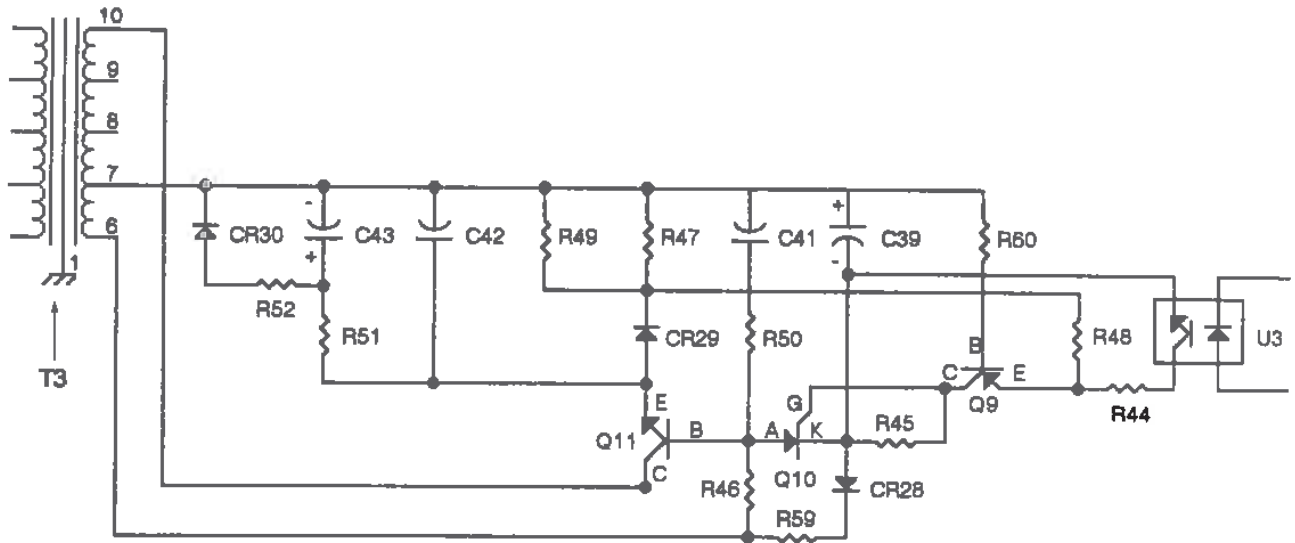

Figure 6-2 Partial schematic of the switching power supply—U.S. analog board.

Visual Inspection

More often than not, once you've opened the set, the solution to the problem will stare right at you. All you have to do is mindfully stare back! Figure 6-3 shows what looks like a cigarette burn at the bottom of the analog board jacket.

When you line up the burn mark with the board, it points to Q11 (INTERNATIONAL Q10). Checking Appendix C for the U.S. analog board, or Appendix D for the International analog board, we find that Q11 is a 100-W power transistor. Looking at the board, we see that Q11 is in the switching power supply section, near T3 at the bottom. The power supply is obviously not working. We know Q11 has been overheating. That's more than enough evidence to indict Q11 right on the spot. Test it using the same method given in Chapter 5 for Q3 (refer to Tables 5-5 and 5-6), and you'll have an easy five-minute conviction.

Believe it or not, the board shown in Figure 6-3 came to me by way of a reasonably competent individual who never even looked at the jacket. So here's a valuable do-it-yourself troubleshooting tip: *Whenever you're faced with a dead set, look long and hard at the jacket, before you look anywhere else!*



Figure 6-3 Visual Inspection. More often than not, the solution will stare right at you. All you have to do is mindfully stare back! Note the “cigarette” burn at the bottom of the jacket.

Use a Magnifying Glass

When there’s no obvious clues on the board or the jacket, make sure the power cord is physically disconnected from the wall outlet, get out a 2.5-inch diameter magnifying glass, and look for hidden clues on the component side of the board. In the old days, this would have been called “going over the animal with a fine-tooth comb.” You know from the symptoms and solutions given at the top of the chapter that the principal suspects of a dead set (when there’s no other evidence of burning) are resistors R52 for the U.S. model and R55 for the International model. When resistors open up, the evidence is often hidden between the resistor body and the circuit board. The air-cooled side of the open resistor may look fine, so you really have to dig for clues. Very often, with a strong light and a magnifying glass, you’ll spot something. Desolder one or both leads to confirm your suspicions. If the resistor looks

burned, check the Appendixes C to F for replacement part information, install a new part, and most likely the set will be fixed.

Be sure to look in the right appendix! Appendix C is for U.S. analog boards. Appendix D is for International analog boards.

Go with the Obvious

Compound problems are much easier to spot. Figure 6-4 contains typical evidence of T1 having shorted while the computer was unattended. This is about as bad as it gets.

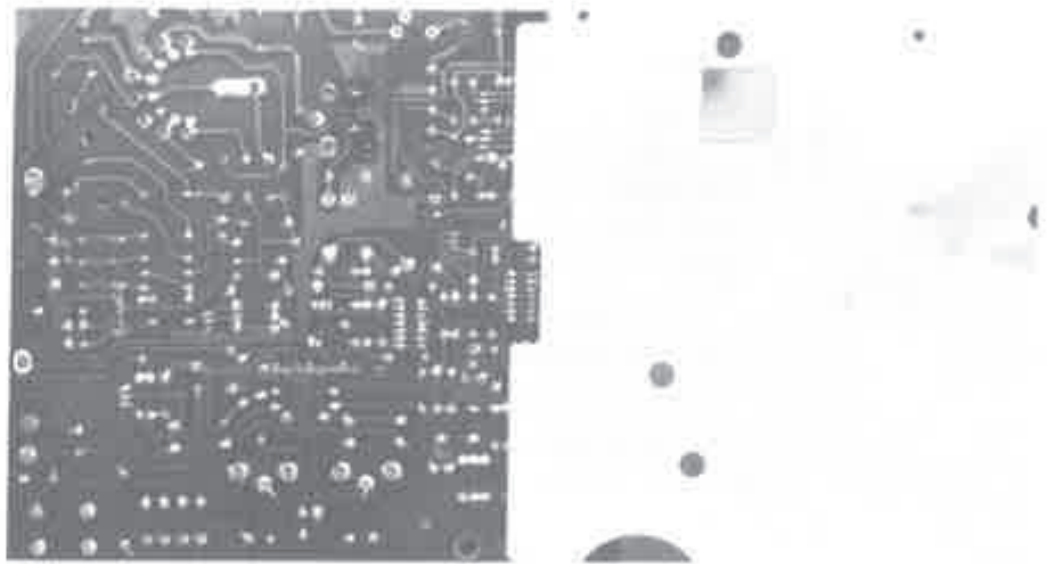

Figure 6-4 Compound problems. Physical evidence of T1 having failed while the computer was unattended.

1. First, the vinyl jacket reveals burning in the area under the upper sticky pad. Note that L2, the width coil, has already been desoldered. Along with C2, it was burned to a crisp!
2. The traces leading to Q3, which were under the upper sticky pad, have completely burned away, as evidenced by the charring. Even though the damage looks irreparable, note that the burned area has been successfully bridged with solid wire and solder. A new Q3 is already in place!

3. J1 was horribly melted. That area looks good, because it's been replaced.
4. T1, the semicircle area in the upper left corner, has also been replaced. We know from experience that T1 failure is what caused the other problems.
5. At the very bottom of the board, in the switching power supply section, note that resistors R46, R47, R49, and R51 have all been removed. When the video section burned, high current was drawn, which caused the resistors to open. Q9 and Q10 also failed.

Odd as it may seem, effecting this kind of repair is completely mechanical. Experience shows that dead sets are caused by open resistors in the power supply, sometimes associated with the failure of Q9 and Q10. The physical evidence shows that the power supply problem was caused by an obvious failure in the high-voltage section. It's always the same parts which fail. Replace the usual parts, and the set will be fine.

Check Resistor Values

Sometimes, burned resistors look fine, but they still test open. So here's do-it-yourself troubleshooting secret number 2: *Whenever visual inspection fails, double-check your findings with a continuity test.* Once again, the principal suspects are resistors R52 (10 k Ω) for the U.S. model and R55 (20 k Ω) for the International model. Here's how to test them:

1. Make sure the power switch is off and, for your own safety, disconnect the computer's power cord from the wall outlet.
2. Open to the correct appendix for your set and look up the first resistor on the list. R52 on the U.S. board is a 1/4-W 10-k Ω carbon film resistor. R55 on the International board is a 1/4-W 20-k Ω carbon film resistor.
3. Turn on your analog multimeter and set it to the R \times 1K scale. Zero the meter. Set your digital meter to read K-ohms.
4. Set up an inspection light as illustrated in Figure 4-9. Locate the suspect resistors on the component side of the board, then locate their corresponding solder joints on the solder side of the board. Touch the black test probe to one lead. Touch the red test probe to the other lead. The meter should indicate approximately 10 k Ω (20 k Ω INTERNATIONAL), even in-circuit. If the meter reads infinity, you've found at least part of the problem.
5. Repeat step four for each of the other resistors on the suspect list. On an analog meter, remember to change resistance scales as necessary. To test R46 (1-W 22- Ω) for example, set your analog meter to the R \times 10 scale. The in-circuit reading should be between 18 Ω and 20 Ω . To test R47, R49, and R50 (1/4-W 1.5- Ω), set your meter to the R \times 1 scale. The

in-circuit reading for these resistors should be approximately 1 Ω . R51 ($\frac{1}{4}$ -W 15- Ω) reads about 12 Ω in-circuit. Anything substantially off the mark, such as infinity or high resistance, indicates a bad part.

Heat Wave Tip

Very often, the sole cause of the problem will be one resistor in the lower right corner of the board, underneath LF2. If the set quit suddenly during a heat wave, go right to R52 on the U.S. board, and R55 on the International board. R55 on the International board is an odd value 20,000- Ω resistor. If you don't have one on hand, you can safely substitute a 22,000- Ω replacement.

Overheated resistors are a common problem in all kinds of electronic equipment. In this case, they indicate that the manufacturer's maximum suggested operating temperature has been exceeded. You can stretch that limit a little by substituting higher wattage replacement resistors. Instead of a $\frac{1}{4}$ -W carbon film resistor (R47-52), use a $\frac{1}{2}$ -W carbon film resistor of the same value. Likewise, instead of a 1-W metal oxide resistor (R46), use a 2-W metal oxide resistor of the same value. Higher power resistors are physically larger. Since they're not expected to work any harder, the extra bulk allows them to dissipate heat better. We'll have more to say about that in Chapter 7, when we discuss power supply upgrades.

Learn the Color Code

With stubborn problems, it's much easier to learn the resistor color codes than it is to flip back and forth to the appendix. By learning to read the color bands on a resistor, you can easily determine its value, even when you're working on a set with no service information. The color code is easy to remember. If you take a few minutes to study the following, you'll never forget how it works:

1. The scale associated with the color code runs from 0 to 9.
2. Black, the absence of all color, has a value of 0. It's at the low end of the scale.
3. White, a mix of all colors is given a value of 9. It's at the high end of the scale. Dwell on the fact that the scale runs from black (no color) to white (full color). The bright colors are sandwiched in between.
4. When resistors overheat, they really BROYL. Note that broil is spelled with a "y" as in the name of Popeye's girl friend, Olive Oyl.
5. The B in BROYL is for Brown, the color closest to black. Since Black is 0, Brown, the first letter in BROYL, has a value of 1.
6. The R in BROYL is for Red. Since R is the second letter in BROYL, Red has a value of 2.

7. The O in BROYL is for Orange. Since O is the third letter in BROYL, Orange has a value of 3.
8. The Y in BROYL is for Yellow. Since Y is the fourth letter in BROYL, Yellow has a value of 4.
9. The L in BROYL represents the Roman numeral L (50) suggesting a green \$5.00 bill (or nice crisp Lettuce.) Green has a value of 5.
10. The only logical color left for 6 is Blue. Green and blue are complementary colors. Blue follows green. Green is the color of lettuce and \$5.00 bills, so Blue, the color of the ocean (the deep six) is 6.
11. After blue comes Violet. Violets are pretty blue/violet flowers. The V in violet resembles a rolled-over 7. Violet follows blue which is 6, so Violet can only be 7.
12. Eight is Gray. It's the only color left between black and white. Mix the two together and the last color has to be Gray.

Memorizing the code this way is called memorization by association. Spend a few minutes making the associations, and you'll never forget them!

High-quality resistors have four color bands. Gold and Silver, usually the last colors, indicate tolerance. The lower the tolerance, the greater the precision. The G in gold stands for Great precision, so Gold is 5 percent tolerance. A gold-striped 100- Ω resistor should measure no higher than 105 Ω and no lower than 95 Ω . Silver, with less precision, is 10-percent tolerance. A silver-striped 100- Ω resistor should measure no lower than 90 Ω and no higher than 110 Ω . The important thing to remember is that whenever you see a gold or a silver stripe, you start counting from the other end.

Here's an example: R52 on the U.S. board is marked with Brown Black Orange, Gold. We know that Gold, Great precision, is the last stripe, so Brown, must be the first stripe. Brown is the first letter in BROYL, so the first digit in R52's color code is the number 1. The second digit is associated with Black, the absence of color, so it must be a 0. The first two digits then are 1 0. The third digit is a multiplier. It tells us how many decimal places to add. Orange is the 3rd letter in BROYL, so Orange is 3. $10 + 000 = 10,000 \Omega$. Table 6-1 puts it all together. This information is also on the bookmark.

Tolerance

Tan-bodied resistors are always 5-percent or 10-percent tolerance, depending on the gold or silver stripe. Blue-bodied resistors are always 1-percent or 2-percent tolerance according to the brown or red stripe.

Table 6-1 Resistor Color Codes

Color	1st & 2nd Band	3rd Band	4th Band
Black	0	+ nothing	
Brown	1	+1 zero	1-percent tolerance
Red	2	+2 zeros	2-percent tolerance
Orange	3	+3 zeros	
Yellow	4	+4 zeros	
Green	5	+5 zeros	
Blue	6	+6 zeros	
Violet	7		
Gray	8		
White	9		
Gold		-1 decimal	5-percent tolerance
Silver		-2 decimals	10-percent tolerance
No 4th Color Band			20-percent tolerance

A problem with some 2-percent resistors can be figuring out which end of the resistor is which. A 220- Ω 2-percent resistor will be marked Red Red Brown, Red. How can you be sure (without checking the appendix) it's not supposed to be Red Brown Red, Red? If it's supposed to be Red Brown Red Red the code calls for 2100- Ω . (Work it out!) Which is it then, 220- Ω or 2100- Ω ? If the resistor is open, how can you tell? The meter is going to read infinity.

To stop that kind of confusion, the color code on a 2-percent resistor is supposed to be off-center. The leading red stripe is supposed to be printed closer to one of the two ends of the resistor than the trailing red stripe. In other words, the color code on a 2-percent resistor should never be perfectly centered, the way it is on a tan-bodied resistor. Unfortunately, sometimes they do appear to be centered. Whenever you run into that in a Mac Plus, look for a similar resistor and measure that one, or check the part number reference in the appendix.

Flapping—Logic Board OK

If the set makes a flup, flup, flup noise when you switch on the power, it means that something is drawing too much current. The first thing to do is to check the setting of R56, the voltage pot. Try turning it down. Someone may have set the voltage too high, or someone may have removed a memory upgrade without thinking to turn down the voltage. In that case, even though the set may have worked fine at the time, it could have failed the next day, because cold starts normally draw more current. This effect is explained in Chapter 3.

The next most likely cause of protective flapping is a failed electrolytic capacitor. On the U.S. board, the suspects are C3, C24, C25, C26, C29, C30, and C31. On the International board suspect C3, C24, C27, C28, C30, C31, and C32. Check for bad caps using visual inspection. Sometimes, as shown in Figure 6-5, the failure is quite obvious. Other times, there's no physical evidence whatsoever. In that case, try the shotgun approach recommended in Chapter 7.

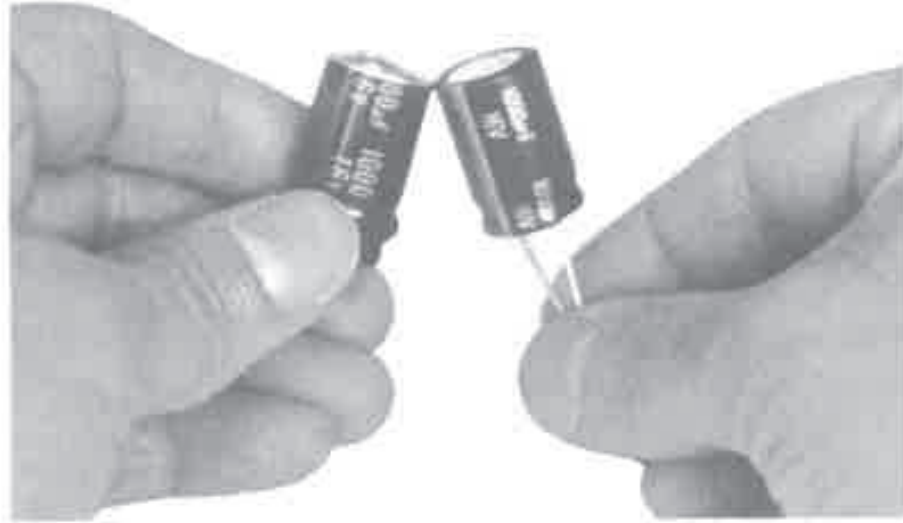

Figure 6-5 Shorted capacitor. Sometimes, electrolytic failure is obvious.

Shorted rectifiers are the next on the list. CR20, the +5.00-V rectifier, is the usual problem, but CR21, CR5, and CR1 are also known to fail. When these parts fail, it's usually with a dead short which makes them very easy to spot. Here's the complete in-circuit test procedure:

1. Make sure the computer's power cord is physically disconnected from the wall outlet.
2. Turn on your analog multimeter and set it to the R \times 10K scale. Zero the meter. Turn on your digital meter and set it to read K-ohms.
3. Set up an inspection light as illustrated in Figure 4-9.
4. Refer to Figure 6-6 for the approximate locations of CR1 and CR5 as viewed through the solder side of an illuminated U.S. analog board. Identify the solder joints for CR1.
5. Touch the black test probe to the solder joint at one end of CR1 and touch the red test probe to the solder joint at the other end. Observe the meter reading and write down the results. Now reverse the probes. Touch the black probe to the solder joint where the red probe was. Touch the red probe to the solder joint where the black probe was. Observe the meter reading and write down the results.

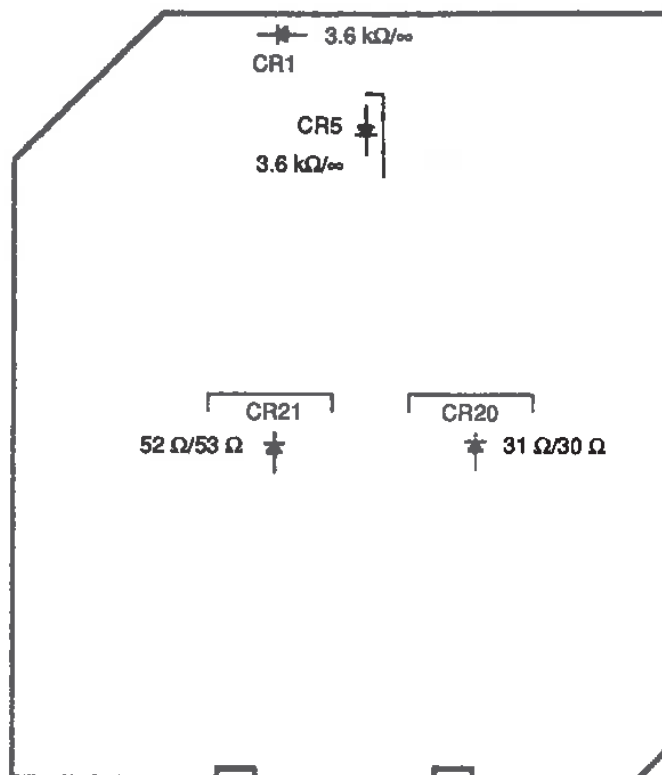

Figure 6-6 The approximate locations of CR1, CR5, CR20, and CR21 as viewed through the solder side of an illuminated U.S. analog board.

6. Repeat steps 4 and 5 for CR5.
7. Switch your analog meter to $R \times 10$. Digital meters should stay on the K-ohms scale.
8. Repeat steps 4 and 5 for CR20 and CR21.
9. Compare your results to Table 6-2.

Table 6-2 In-Circuit Ohmmeter Test for CR1,5,20,21

Reference	Typical Good Results	Bad Results
CR1	$3.6 \text{ k}\Omega/\text{Infinity}$	$0 \Omega/0 \Omega$
CR5	$3.6 \text{ k}\Omega/\text{Infinity}$	$0 \Omega/0 \Omega$
CR20	$31 \Omega/30 \Omega$	$0 \Omega/0 \Omega$
CR21	$52 \Omega/53 \Omega$	$0 \Omega/0 \Omega$

Anything close to the typical results given in Table 6-2 indicates the rectifier is OK. All you're really looking for is a dead short (0Ω .) If you find one, remove the component and test it out-of-circuit. Without the influence

of other components in the circuit, these rectifiers should read $2\text{ M}\Omega$ to infinity in one direction and approximately 10 to 20 $\text{k}\Omega$ in the other. If they test OK out-of-circuit, the real failure will still be on the board, somewhere near the rectifier. More often than not, the failed component will be right in your hand.

In the event you find that CR21, the +12.00-V rectifier, is shorted, then Q8, the "crowbar" SCR, may turn out to be open. As shown in Figure 6-7, Q8's function is to shut down the +12.00-V power supply whenever there's an overvoltage situation. If the overvoltage situation goes on for very long, Q8 may self-destruct (open up) producing a dead set which was previously a flapping set. In that case, even after you install a new rectifier, the computer will still be dead.

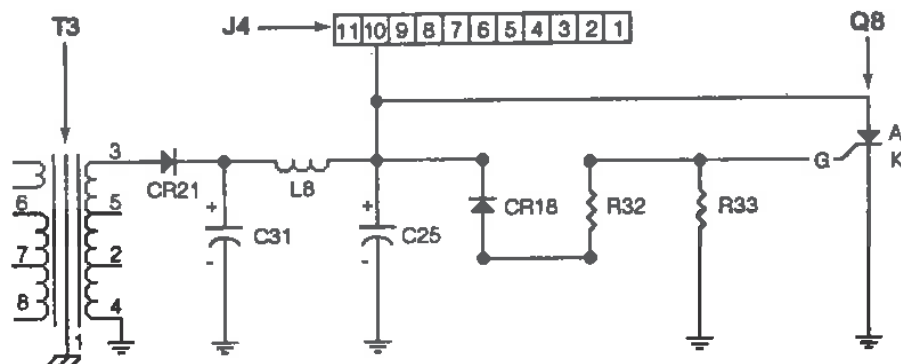

Figure 6-7 Q8's function is to shut down the +12.00-V power supply whenever there's an overvoltage condition. Output goes to ground instead of to J4, pin-10.

Here's how to test Q8:

1. Lay the Macintosh on its side, so that the solder side of the analog board is facing up.
2. Desolder the three leads according to the general desoldering instructions given in Chapters 4 and/or 11.
3. Turn on your multimeter and set it to the $R \times 100$ scale. Refer to Tables 6-3 to 6-4 to test the part.

Q8's anode, cathode, and gate junctions are identified in Figure 6-8. To make the cathode-to-gate test, clip the red lead to the cathode and the black lead to the gate. If the SCR is good, you'll read approximately $50\ \Omega$ as shown in Table 6-3. If it's bad, you'll read approximately $475\ \text{k}\Omega$ as shown in Table 6-4. Now reverse the leads. Clip the black lead to the cathode and the red lead to the gate. $50\ \Omega$ in this direction also indicates a good part. Infinity indicates a bad part.

Table 6-3 Good Q8 (2N6394) Test Results—Out-of-Circuit

Junction	Red/Black	Black/Red
Anode/gate	Infinity	Infinity
Anode/cathode	Infinity	Infinity
Cathode/gate	50 Ω	50 Ω

Table 6-4 Bad Q8 (2N6394) Test Results—Out-of-Circuit

Junction	Red/Black	Black/Red
Anode/gate	Infinity	Infinity
Anode/cathode	Infinity	Infinity
Cathode/gate	475 kΩ	Infinity

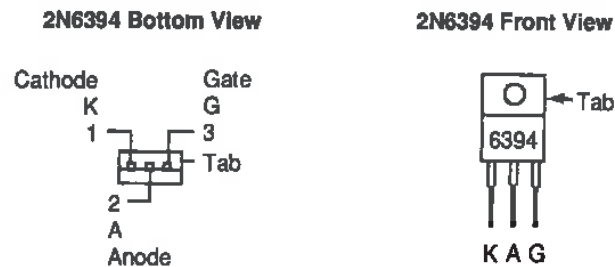

Figure 6-8 Q8 (2N6394) lead identification. The tab is common to the anode.

A good 2N6395 SCR will generally test according to Table 6-3. A bad 2N6395 SCR won't necessarily test according to Table 6-4, but the readings given are fairly consistent for failures in this particular circuit.

Flipping Set—Analog Board OK

Sometimes, protective flapping is caused by a problem on the logic board. The way to tell for sure is to swap the suspect logic board with a compatible logic board taken from a known good set. 128K, 512K, 512Ke, and Mac Plus logic boards are all compatible. If you're working on a Mac Plus, you can safely swap the 1024K logic board for a 128K logic board. If the flapping continues, you know the problem is in the Mac Plus analog board. If the flapping stops, that proves the Mac Plus analog board is OK.

In that case, suspect the TSM chip on the logic board at grid reference D1. Another (less likely) possibility is Q1, the 7905CT regulator at grid reference, A-8. Q1's input, output, and common junctions are identified in Figure 6-9. Out-of-circuit test results are given in Tables 6-5 and 6-6. These results are taken with a high-impedance digital multimeter on the $k\Omega$ scale. Your readings may vary.

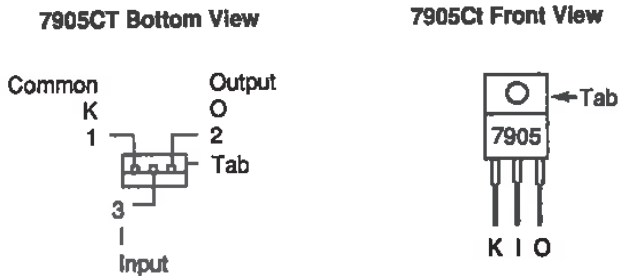

Figure 6-9 Q1 (7905CT) lead identification. The tab is common to pin-3.

Table 6-5 New Q1 (7905CT) Test Results—Out-of-Circuit

Junction	Red/Black	Black/Red
Output/common	10.6 $k\Omega$	10.6 $k\Omega$
Output/input	Infinity	495 $k\Omega$
Input/common	506 $k\Omega$	Infinity

Table 6-6 Questionable Q1 (7905CT) Test Results—Out-of-Circuit

Junction	Red/Black	Black/Red
Output/common	2.3 $k\Omega$	2.3 $k\Omega$
Output/input	1.1 $M\Omega$	511 $k\Omega$
Input/common	512 $k\Omega$	1.1 $M\Omega$

Working on the logic board requires special technique. Before desoldering either of these components, read Chapter 10!

Summary

Dead sets are usually caused by open resistors in the power supply, sometimes associated with the heat related failure of Q9 and Q10. Other times, these failures are associated with component failures in the high-voltage section.

Flapping occurs when SCR Q8 in the OVP (overvoltage protection) circuit "crowbars" the power supply in response to an overvoltage condition. The usual cause is a shorted rectifier or a failed electrolytic capacitor. Sometimes, the TSM chip on the logic board is at fault.

In the next chapter we're going to talk about power supply upgrades. We'll speculate as to why these parts fail and reveal proven ways to keep them from ever failing again.

CHAPTER



7

Power Supply Upgrades—Fans

This chapter covers 128K to Macintosh Plus power supply upgrades and shows how to install internal cooling fans. It assumes that you have the necessary tools, that you know how to get the back off the set, and that you've had previous soldering experience. If necessary, please review Chapters 1, 2, and 4 for specific details.

The Failure Avoidance Strategy

The failure avoidance strategy states that for any given situation, if you can eliminate all possible causes of failure, then success is guaranteed. After five years, with millions of Macs in the field, we already know which parts fail. We don't have to guess any more. It's always the same parts. We also know that most of the component failures are heat related. To avoid repeat component failures then, all we have to do is:

1. Substitute high-temperature replacement parts for those that are known to fail.
2. Lower the set's operating temperature so that the parts originally specified no longer fail.
3. Substitute high-temperature replacement parts, and lower the set's operating temperature, so that repairs last even longer.

This chapter shows how to effect all of the above failure avoidance strategies. The first section shows how to upgrade an older analog board to

the latest official Mac Plus/Mac SE standards. The second section takes a similar approach, but additional changes are specified for even greater reliability. The third section deals with cooling fans. For total protection, you can fit any 128K to Mac Plus with the same style fan currently supplied with the Macintosh SE.

Minimum Analog Board Upgrade

Table 7-1 provides the parts list for a minimum analog board upgrade. To use this table, open your Mac and find the board references listed under the first column. Then, compare the markings on the currently installed parts to the original specifications listed in the middle column. Whenever the markings indicate that originally specified parts are present, replace them (even if they're still working) with their heavy-duty counterparts specified in the third column.

Not only will this upgrade raise your analog board to the latest Mac Plus/Mac SE standards, but just by performing the minimum upgrade, you can fix a high percentage of broken Macs. If you can wield a soldering pencil, try replacing the parts listed in Table 7-1, and chances are better than 50/50 that the problem will be solved.

Table 7-1 Parts List for Minimum Analog Board Upgrade

Ref.	Check for	Change to
C1	3.9 mfd BP (HF) 25 V 85 °C	3.9 mfd BP (HF) 35 V 85 °C
C24	2200 mfd 10 V 85 °C	2200 mfd 16 V 105 °C
C29	2200 mfd 10 V 85 °C	2200 mfd 16 V 105 °C
CR20	IR31DQ 40 V 5 A	MBR1035 35 V 10 A
T1	Non-bleeder flyback	Bleeder-type flyback
none	805-0563 upper RFI shield	Desolder and remove
none	805-0577 lower RFI shield	Insulate with tape
none	22 AWG J4-J7 harness	20 AWG J4-J7 harness

Rationale for the Changes

C1, the horizontal deflection capacitor, is probably the single most common failure on the Macintosh analog board. The new 35-V replacement capacitor is physically larger than the original 25-V model, and since the operating voltage is still 21 V DC, the extra 10-V capacity allows it to dissipate heat better. The same rationale applies to the new 16-V ratings for C24 and C29.

The old CR20 is a 5-A 40-V barrel-style Schottky diode. The new CR20 is a 10-A 35-V TO-220-style Schottky rectifier. The 10-A parts can withstand high temperatures better, and are known to be more reliable. Mounting instructions for the new parts are shown in Figure 7-1. Take care not to discard the old heat sink. Macintosh heat sinks are hard to come by. Old heat sinks have to be recycled.

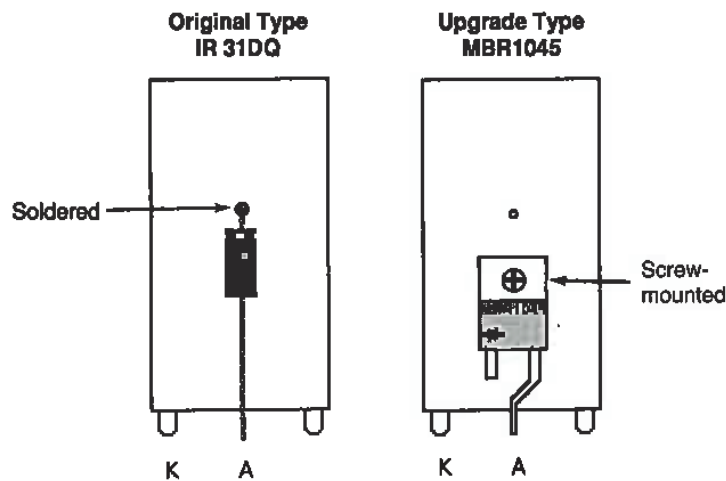

Figure 7-1 Mounting details for CR20 and CR21 upgrades.

The latest Mac SE-style flyback transformer is UL-approved. It's physically larger than any previous 128K to Mac Plus flyback transformer, and by the same rationale given above, the extra bulk allows it to dissipate heat better. It's also equipped with a bleeder resistor that automatically discharges the CRT on power down. With the new style of transformer, you can minimize the possibility of future failures while upgrading to the latest Macintosh SE standards.

As shown in Figure 7-2, 805-0563 upper RFI shields originally ran along the top of the analog board in the area of C1, J1, L2, and T1. New analog boards don't have them. The removal of this shield (if encountered) upgrades an older board to the latest Mac Plus specification, and more importantly, it increases convective cooling.

As shown in Figure 1-9, 805-0577 lower RFI shields fit over the I/O (input/output) connectors (the mouse, disk drive, printer, modem, and speaker ports) on the logic board. On 128K to 512Ke Macs, this shield should be removed and examined. Older shields were only insulated at the tip. As explained in Chapter 8, eventual metal fatigue can cause short-circuits to the logic board. To prevent that, new shields are completely insulated. Upgrade to the latest Mac Plus specification by covering the underside of an older shield with clear, 2-inch wide package sealing tape.

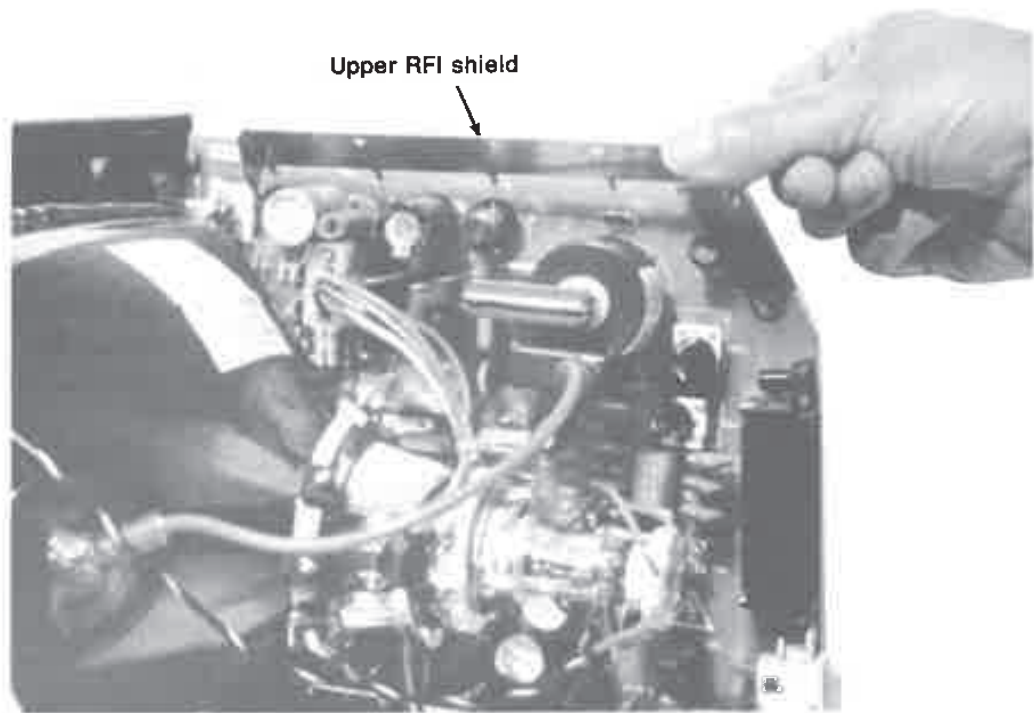

Figure 7-2 Location of part #805-0563, the upper RFI shield.

Some older sets are equipped with 22-AWG J4-J7 harnesses. As explained in Chapter 4, these can cause excessive voltage drop. New sets all come with 20-AWG harnesses. 18-AWG is even better. No upgrade is complete without at least a 20-AWG harness.

Maximum (Heavy-Duty) Analog Board Upgrade

Table 7-2 provides a parts list for a heavy-duty analog board upgrade. To use this table, open your Mac and find the board references listed under the first column. Then, compare the markings on the currently installed parts to the original specifications listed in the middle column. Whenever the markings indicate that originally specified parts are present, replace them with their super heavy-duty counterparts specified in the third column.

This upgrade takes your analog board beyond the latest Mac Plus standards, and because more parts are changed, it fixes an even higher percentage of broken Macs. Experience shows that three out of four broken analog boards can be repaired *without troubleshooting* just by installing the heavy duty upgrade. Figure 7-3 shows a commercial version of the complete upgrade kit. Mail order vendors are listed in Appendix B.

Table 7-2 Parts List for Maximum Analog Board Upgrade

Ref	Check for	Change to
C1	3.9 mfd BP (HF) 25 V 85 °C	3.9 mfd NP HF 100 V 85 °C
C3	220 mfd 10 V 85 °C	220 mfd 16 V HF 105 °C
C24	2200 mfd 10 V 85 °C	2200 mfd 16 V HF 105 °C
C25	1000 mfd 16 V 105 °C	1000 mfd 25 V HF 105 °C
C26	1000 mfd 16 V 105 °C	1000 mfd 25 V HF 105 °C
C29	2200 mfd 10 V 85 °C	2200 mfd 16 V HF 105 °C
C30	220 mfd 10 V 85 °C	220 mfd 16 V HF 105 °C
C31	1000 mfd 16 V 105 °C	1000 mfd 25 V HF 105 °C
CR1	GI 854 3 A	MR 824 5 A
CR5	GI 854 3 A	MR 824 5 A
CR20	IR31DQ 40 V 5 A	
or	MBR 1035 35 V 10 A	MBR1045 45 V 10 A
CR21	IR31DQ 40 V 5 A	MBR1045 45 V 10 A
T1	Non-bleeder type flyback	Bleeder-type flyback
None	805-0563 upper RFI shield	Desolder and remove
None	805-0577 lower RFI shield	Insulate with tape
None	20 or 22-AWG J4-J7 harness	18-AWG J4-J7 harness

Rationale Behind the Capacitor Upgrades

Standard, generally black-jacketed, aluminum electrolytic capacitors are rated for 1000 hours of operation at +85 °C. Note that a 1000-hour rating doesn't necessarily mean the part is going to fail immediately after 1000 hours, it just means that the manufacturer only guarantees specifications will be met for 1000 hours. Since 1000 hours divided by 40 hours per week equals 25 weeks, 1000-hour OEM parts limit your minimum expectations to 6 months of trouble-free use. With the 2000-hour replacement parts, you can logically raise that minimum expectation to a full year of trouble-free use.

In addition, test results published in Nichicon Catalog 8100A (Nichicon is a Japanese capacitor manufacturer) show that the life of a capacitor is reduced approximately by one-half for each temperature increase of 10 °C. Hence, the replacement capacitors are specified at +105 °C, instead of +85 °C. The higher temperature rating extends the life of the part by about 20%.

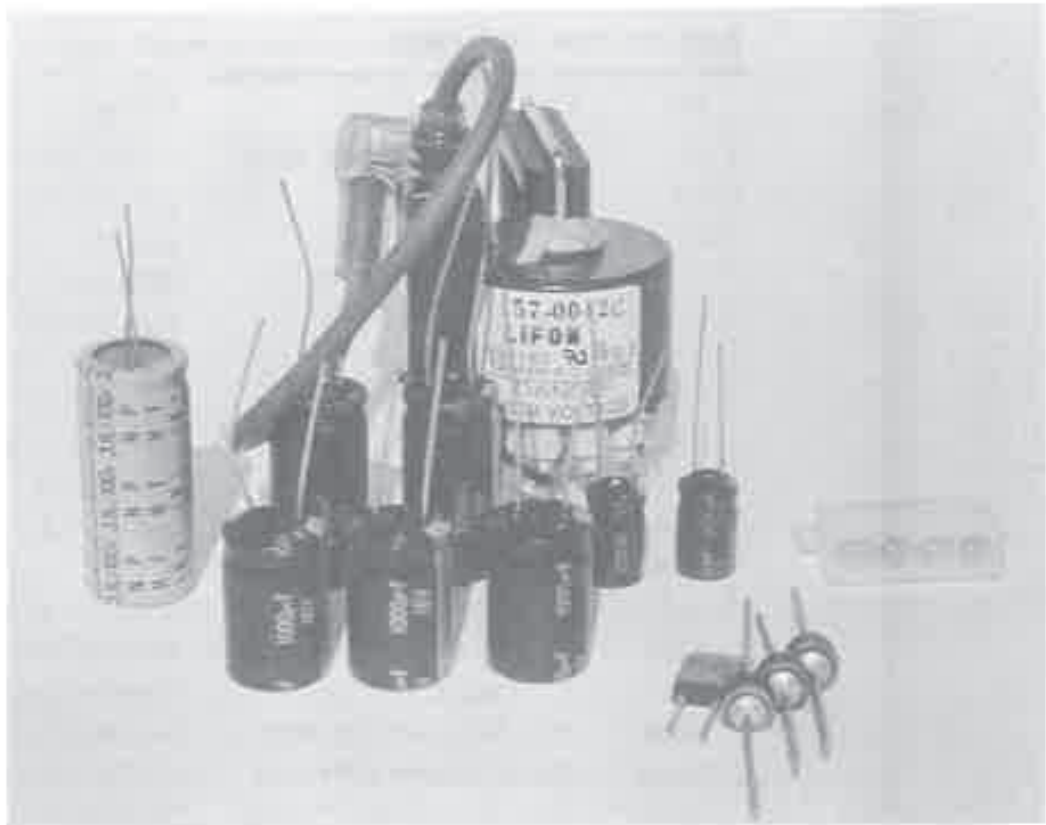

Figure 7-3 Heavy-duty upgrade kit for the 128K to Mac Plus analog board.

The HF (high-frequency) rating reduces impedance which is particularly important in a switch mode power supply. The effects of high frequency on capacitor life were explained in Chapter 5.

Finally, the voltage ratings have also been increased, to obtain larger surface areas. The larger surface areas are known to dissipate heat better. This is a common trade practice when the parts originally specified are believed to have suffered heat related failure.

Rationale Behind the Rectifier Upgrades

CR1 and CR5 are both 3-A GI 854 barrel diodes. These are known to deteriorate rapidly and fail suddenly, usually with a dead short as explained in Chapter 6. 5-A MR-824 replacement diodes have 66% more current capacity. Experience shows that they do not fail under the identical high temperature conditions.

CR20, originally an IR31DQ 5-A Schottky barrier diode, has been officially upgraded to an MBR1035 10-A 35-V TO-220 Schottky barrier rectifier. These parts are much better, but for a few extra pennies, you can buy an MBR 1045, rated 45 V, and have that much more protection.

CR21, another IR31DQ5-A Schottky barrier diode, is also changed to an MBR1045. Although the incidence of CR21 failure is less, a particularly bad sign is that its leads tend to blacken, like overheated grill wires on a backyard barbecue. With MBR1045 replacement parts, the leads on CR20 and CR21 stay nice and shiny. Shiny leads indicate cool operation. Cool running rectifiers will last indefinitely.

Other Considerations

If you're upgrading a live set, remember that you also have to reset the +5.00 V and realign the video as explained in Chapters 2 and 3.

If you're upgrading a dead set, remember to check Q3 (Q2 International) as explained in Chapter 5, before powering up. Otherwise, you may destroy the new flyback transformer. If the set is still dead after completing the upgrade, check the switching power supply section of the analog board as explained in Chapter 6. Once you get the bong! and the display back, reset the +5.00 V and realign the video as explained in Chapters 2 and 3.

Analog Board—Removal and Installation

This section reviews the complete analog board removal and installation procedure. It's generally not necessary to remove the board in order to upgrade it, but you may wish to do so if you decide to ship your board to a mail-order service center. Seasoned veterans can probably skip this section, but if you're new to Mac repairs, you'll find the following summary of the removal and installation procedure very useful.

Removal Instructions

1. If the set is on, power down normally and switch off the power.
2. Physically disconnect the power cord from the wall outlet. If you're the least bit hesitant about discharging the CRT, leave the set disconnected overnight. By the next morning, most, if not all, of the high-voltage charge will have dissipated.
3. Remove all rings, watches, and jewelry. Open the case as described in Chapter 1.
4. As shown in Figure 4-15, disconnect the J4 (analog board) to J7 (logic board) cable by pulling straight up.
5. Discharge the CRT through a 10-meg resistor as shown in Figures 1-13 to 1-15.
6. As shown in Figure 5-16, remove the high-voltage lead from the top of the flyback transformer to the anode well of the CRT.

7. Disconnect the J1 (analog board) to CRT (yoke) cable. As shown in Figure 7-4, use a 6- to 8-inch long $\frac{1}{8}$ -inch screwdriver to pry back the connector lock, and pull the wires straight back.
8. Disconnect the J2 (analog board) to CRT (socket cable). Grab the cable by the wires at the J2 end, and pull straight back.
9. Unscrew the ground wire. As shown in Figure 7-5, the ground wire extends from LF2 to the back of the frame.
10. Unscrew the analog board. As shown in Figure 7-5, there are two screws in the lower rear corner of the board, and one screw on the right side of the board. All three screws hold the board to the side of the frame.
11. Remove the board. Slide the board backwards $\frac{1}{4}$ inch or so and lift it straight up. Be careful that the loose wiring harnesses don't snag on the neck of the CRT.

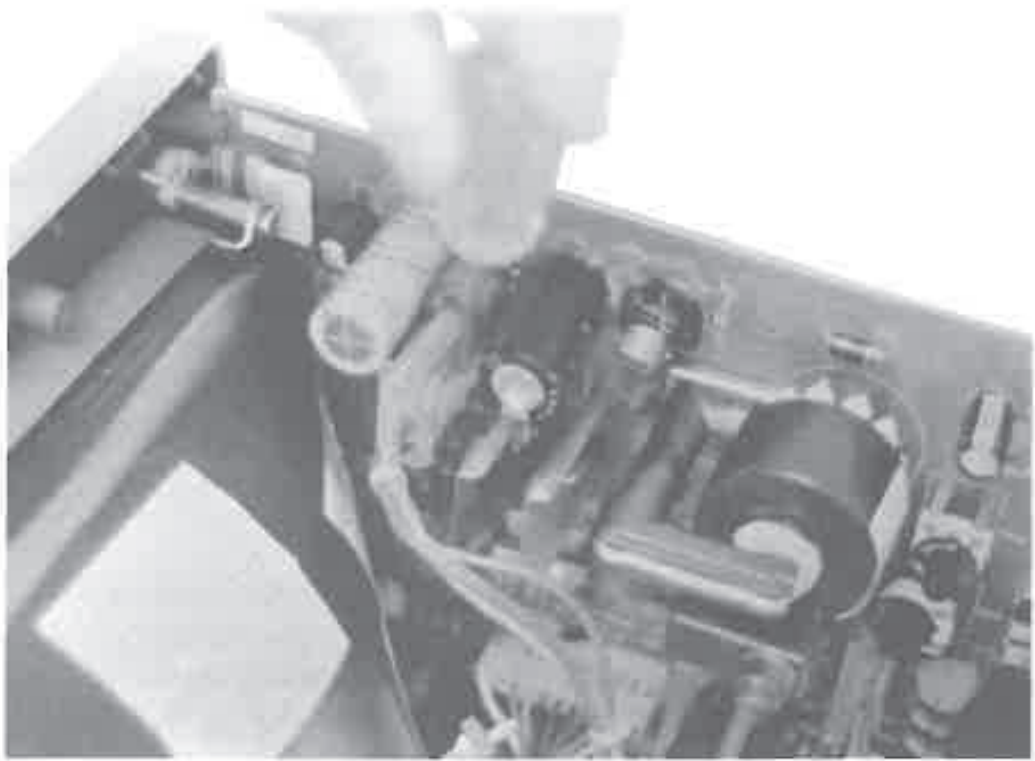

Figure 7-4 To disconnect the J1 (analog board) to CRT (yoke) cable, pry back the connector lock with a 6- to 8-inch long $\frac{1}{8}$ -inch screwdriver and pull the wires straight back.

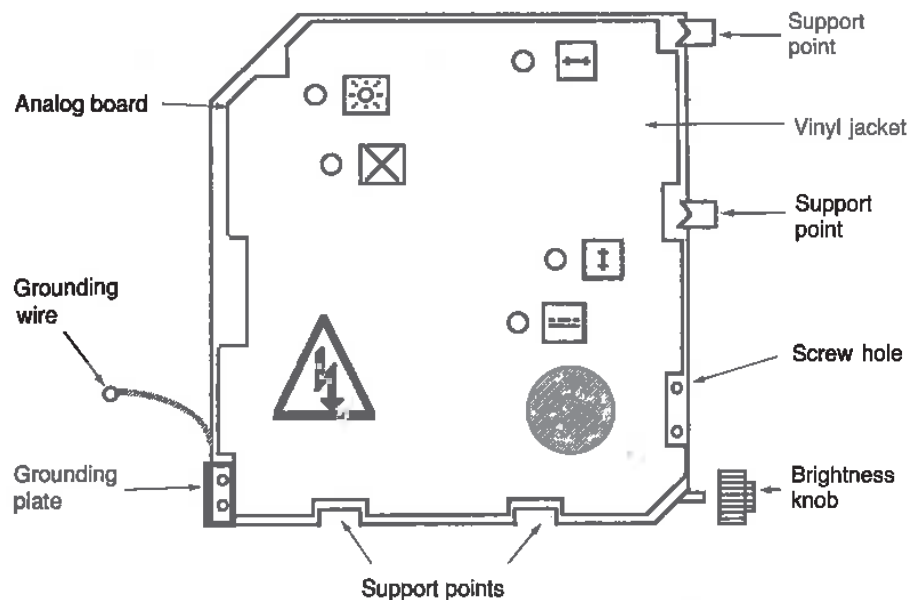

Figure 7-5 Analog board mounting details.

If you intend to send the analog board out for service, remove the grounding plate from the lower back corner of the board, the brightness control knob from the lower front corner of the board, and the J4 (analog board) to J7 (logic board) cable from the J4 connector. That precludes the possibility of their getting lost at the service center. In packing, be especially careful of the brightness control potentiometer. It sticks out and is easily snapped off, with replacements very scarce and expensive.

Installation Instructions

1. Install the brightness control knob. As shown in Figure 7-5, it fits over the brightness control shaft in the lower front corner of the board.
2. Plug the J4 (analog board) to J7 (logic board) cable into J4.
3. Install the grounding plate. As shown in Figure 7-5, it covers the two screw holes at the lower back corner of the board. If the grounding plate is missing, or if you never had one (because someone else lost it), fabricate a new one from aluminum step flashing or thin sheet metal. Cut up the top of a coffee can with tin snips if necessary. The approximate size is indicated on the board.
4. Check for the presence of a vinyl jacket. As shown in Figure 3-2, this jacket provides a handy tune-up reference, plus it insulates you from

exposed solder connections. If installation is necessary, be sure to relocate the upper sticky pad as shown in Figure 4-7. Don't reapply any kind of sticky pad over the J1 connector, or you may regret it!

For safety, the vinyl jacket *must* be replaced. The inside surface of the Macintosh cover is coated with metallic paint. The paint is conductive. Without any insulation between the paint and the solder points, any pressure applied to the left side of the computer could result in a dangerous short circuit.

5. Remount the supply. As shown in Figure 7-5, there are four support points for the board. The first two support points are along the front edge of the cabinet. The upper point looks like an upside-down, toy clothespin. The third and fourth support points are metal tabs extending from the top of the chassis. Make sure the board is locked into all four support points, then fasten the board using three, gray-metal Phillips head screws and lock washers. Two screws mount through the grounding plate at the lower left corner of the board. One screw mounts part way up the right side of the board.
6. Reattach the ground wire extending from LF2 to the back of the frame using a gray-metal Phillips head screw and a lock washer. Tighten the ground screw firmly. If it loosens, the Macintosh will make a buzzing sound.
7. Plug the J4 (analog board) to J7 (logic board) cable into J7.
8. Plug the CRT (socket) to J2 (analog board) cable into J2. Gently slide the socket all the way home on the neck of the CRT.
9. Plug the CRT (yoke) to J1 (analog board) cable into J1.
10. As shown in Figure 5-16, reconnect the high-voltage lead from the top of the flyback transformer to the anode well of the CRT.
11. Set up a multimeter to read 6 V DC. As shown in Figure 3-5, insert the multimeter's red probe into socket 6, alongside the blue wire in the J7 (logic board) connector. Clip the black probe to the chassis.
12. Perform a power up test. Plug the AC cord into an outlet and switch on the power. The Macintosh should bong. The usual floppy disk icon with a blinking question mark should appear. If the set bongs, but the display is dark, raise the brightness level by adjusting R57 with the front panel brightness control knob.
13. Reset the voltage. Adjust R56, the voltage pot, as explained in Chapter 3, until the multimeter reads +5.00 V to +5.01 V DC (no more, no less).
14. Realign the video (the height, width, centering, and so on) as explained in Chapter 3.

15. Choose Control Panel from the Apple menu. Use the Control Panel dialog box to reset the time, the date, and other preferences.

Fan Upgrades

As much as we all would like totally silent computers, the fact of the matter is that uncooled electrical equipment runs hot. Most of the Mac's power supply problems (128K to Mac Plus) can be traced to heat related failure. Even with a heavy-duty power supply upgrade, the best way to completely eliminate these problems is with an internal fan. This section covers both piezoelectric and boxer fans and reveals everything you need to know to install either type of fan yourself.

Piezoelectric Fans

When certain ceramic and crystalline (dielectric) substances are vibrated, by stylus pressure as in a phonograph cartridge or by air pressure as in a microphone, the result is an electric current. Conversely, when dielectric materials are subjected to electricity, the result is vibration. Piezoelectric fans use this principal to flex twin mylar (dielectric) blades at 60 or 50 cycles per second, same as the AC line frequency. Wired for 115 V, the result is 3600 vibrations per blade, or 7200 total vibrations, per minute (60 cycles per second \times 60 seconds per minute \times 2 blades per fan = 7200 total vibrations per minute). Wired for 220 V, the result is 3000 vibrations per blade, or 6000 total vibrations, per minute (50 cycles per second \times 60 seconds per minute \times 2 blades per fan = 6000 total vibrations per minute). The blades work exactly the same as a tiny pair of hand-held paper fans, except the action is completely automatic, and much faster.

All piezoelectric fans (regardless of brand name) are stamped "Piezo Electric Products, Metuchen, N.J." An unbranded fan is shown in Figure 7-6. OEM specifications are given in Table 7-3.

Allowable Use As shown in Figures 7-7 to 7-8, the OEM fan can be wired for either 115-V AC 60-Hz operation, or for 220-V AC 50-Hz operation. By wiring the leads accordingly, an OEM piezo fan may be used with any International or U.S. version of the Macintosh analog board. It can also be used with Macs powered from emergency generators, provided the applied voltage does not exceed 125 V AC or 250 V AC. Uninterruptable power supply use (UPS) is also permissible, provided the supply uses a sine wave voltage inverter. Square wave inverters will make the fan blades buzz. By adhering to these specifications, OEM piezo fans can be adapted to virtually any situation—urban, rural, or outback—anywhere in the world.



Figure 7-6 Piezoelectric fan—unbranded OEM model.

Table 7-3 Specifications for OEM Piezoelectric Fan

Capacity	7 CFM (cubic feet per minute)
Noise level	35 dB (decibels) at three feet
Air intake	Top and bottom
Power	0.11 W at 115 V AC 60 Hz
Line voltage, frequency	115 V AC 60 Hz/220 V AC 50 Hz - selectable
Current requirements	4 mA RMS
Minimum operating temp.	0 °F (-18 °C)
Maximum operating temp.	+158 °F (+70 °C)
Weight	1.2 ounces (35 grams)
EMI	None
RFI	None
Service life	> 35,000 hours

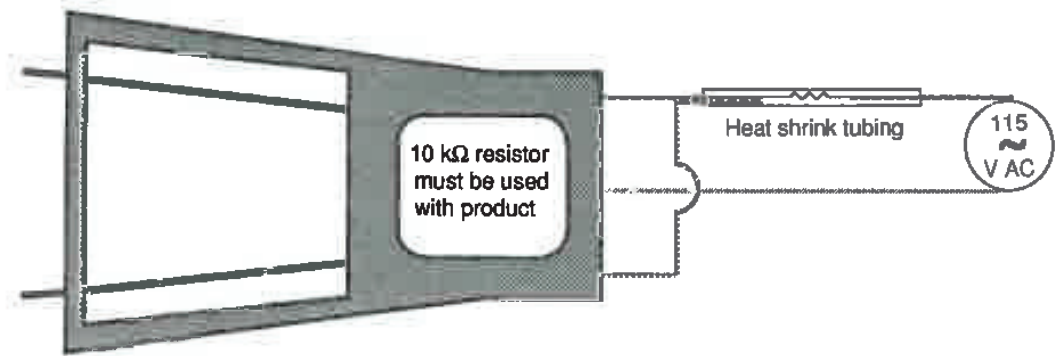

Figure 7-7 Wiring details for 115-V AC 60-Hz piezoelectric fan. The outer fan wires are tied together and go through a 10-k Ω resistor to one side of the AC line. The inner fan wire goes to the other side of the AC line.

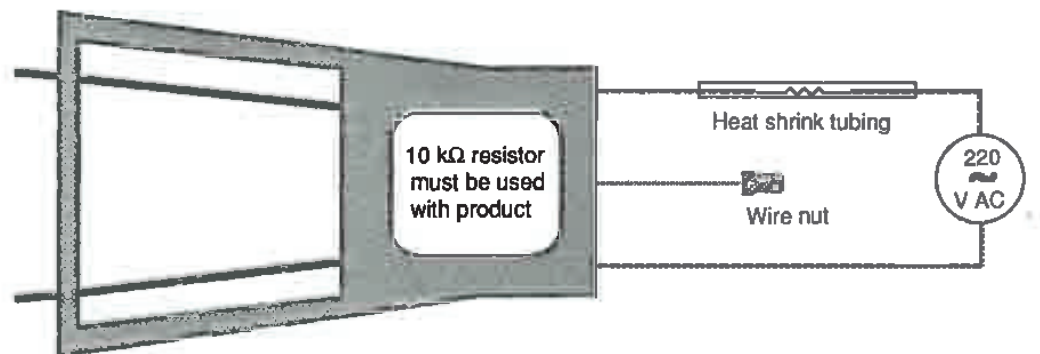

Figure 7-8 Wiring details for 220-V AC 50-Hz piezoelectric fan. One of the outer fan wires goes through a 10-k Ω resistor to the AC line. The other outer fan wire goes directly to the AC line. The inner fan wire is tied off.

Macintosh Installation As shown in Figure 7-9, the fan itself attaches to the disk-drive mounting bracket with a 1.25-inch length of 1-inch wide foam mounting tape. Use the side of the drive for vertical mounting. Use the top of the drive for horizontal mounting. Vertical mounting is shown in Figure 7-9. It's best to use several pieces of tape. Although one piece is more than enough to hold the fan in place, two or even three pieces, stuck one on top of the other, provide extra dampening. Without lots of dampening material between the fan body and the chassis, you may feel subtle vibrations in your forearms. After a while it becomes very unpleasant. If you're sensitive to that kind of thing, use lots of sticky tape!

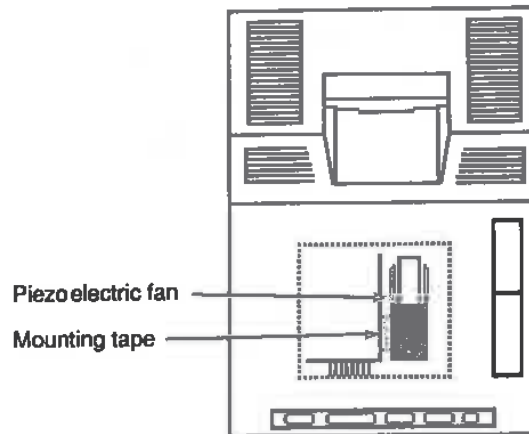

Figure 7-9 Attach the fan to the disk-drive mounting bracket with a 1.25-inch length of 1-inch wide foam mounting tape.

As shown in Figure 7-10, the 115-V AC fan wires connect to the top of diodes CR23 and CR24 on the U.S. analog board.

For a permanent connection, tin the fan leads and tack them directly to the diodes. For a removable connection, tin the fan leads and solder them to a pair of micro test clips. As shown in Figure 7-11, micro test clips come in 1-inch, 1.5-inch, and 2-inch lengths. All sizes work fine. The tops are merely press-fit into the base and separate easily as shown. All you have to do is pull slightly to remove the top. This kind of test clip has a spring-loaded 90-degree hook bend that's ideally suited for clipping onto component leads. It only takes two seconds to attach them, but at the same time, until someone pushes the spring release, they positively stay put.

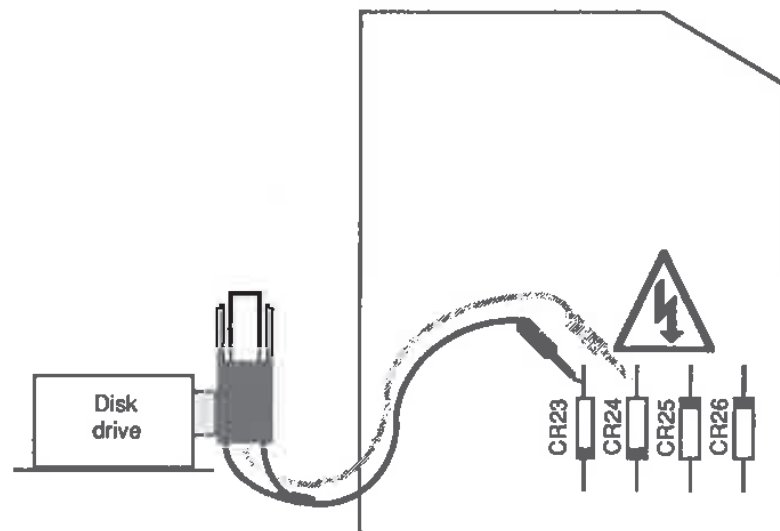

Figure 7-10 On the U.S. analog board, 115-V AC fans connect to the top of diodes CR23 and CR24.

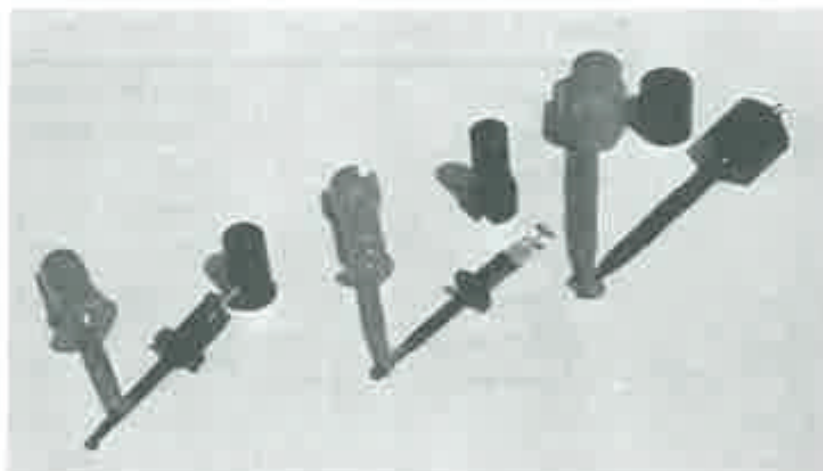

Figure 7-11 Micro test clips come in 1-inch, 1.5-inch, and 2-inch lengths. All sizes work fine. All you have to do is pull slightly to remove the top.

Here's how to attach micro test clips to the fan leads:

1. Strip off about $\frac{1}{16}$ -inch of insulation from each fan lead.
2. Pop the tops off the micro test clips and slide the tops onto the wires. Make sure they're oriented correctly. If you slide them on upside down, you won't be able to fit the clips back together when you're done!
3. If possible, secure the lower half of the test clip in a vise. Otherwise, ask a steady-handed helper to hold them with a pair of pliers.
4. Lay the tinned wire parallel to the lower clip and just tack the leads to the clip metal. Don't use very much solder!
5. Push the tops back into place. Adjust the wires as necessary so that the spring-loaded plungers still work, and that's it!

Soldering test clips to the fan leads is easier done than said, especially once you've tried it. The two secrets are to set up the exact angle of the wire before you heat the metal, and to use as little solder as possible.

DC Boxer Fans

In technical jargon the word "boxer" refers to an axial device furnished with a bushing or a box. In this case, it simply means a small rotating fan with an integral box-like mounting frame. Boxer fans are standard equipment on just about every computer made except the early models of the Macintosh. To upgrade, these computers can be retrofitted with the same size fan supplied in the Macintosh SE. The correct size measures $2\frac{3}{8}$ -inches square by 1.0-inch to 1.25-inches thick. A typical model is shown in Figure 7-12. OEM specifications for these are given in Table 7-4. The usual 128K to Mac Plus mounting location is shown in Figure 7-13.

Table 7-4 Specifications for Panaflo Boxer Fan

Capacity	12 CFM (cubic feet per minute)
Noise level	24 dB (decibels)
Air intake	Rear
Power	0.9 W at +12 V DC
Line voltage	+12 V DC (+15%/-15%)
Current requirements	120 mA at +12 V DC
Minimum operating temp.	14 °F (-10 °C)
Maximum operating temp.	+158 °F (+70 °C)
Weight	4.5 ounces (131.25 grams)
EMI	Not specified
RFI	Specified as low
Service life	> 40,000 hours

**Figure 7-12** Boxer fan—128K to Mac Plus computers can be retrofitted with the same size fan supplied in the Macintosh SE.

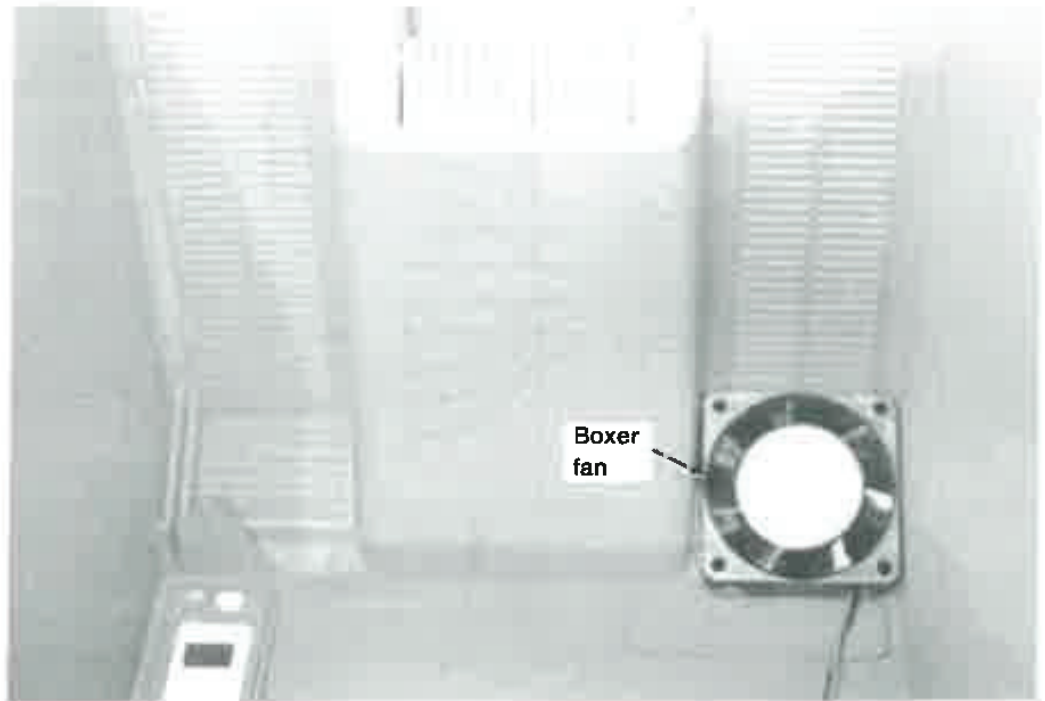

Figure 7-13 Boxer fans mount inside the cabinet, underneath the left rear exhaust vent.

128K to Macintosh Plus Installation Mount the fan with double-sided tape or use thin tie wraps. Electrically, the red fan lead connects to the yellow wire (+12 V DC) on pin-10 of the J4 (analog board) to J7 (logic board) cable, and the black fan lead connects to the violet wire (DC ground) on pin-7. Cut the tie wrap at the J4 end of the harness to loosen the wires, then, as illustrated in Figure 7-14, slip the pins out of their sockets by pressing on the pin locking flanges with a small screwdriver. First push the wires forward to free the locking flanges from the connector housing, then, as you press down on the flanges, pull the wires straight back. It's not necessary to completely remove the wires from the connector. All you have to do is expose a little pin metal so that you can tack on tinned extension wires. Tack on 18-inch lengths of stranded 20-AWG wire and attach these to the fan leads with small wire nuts, or better still, use a two-conductor plug and socket disconnect set.

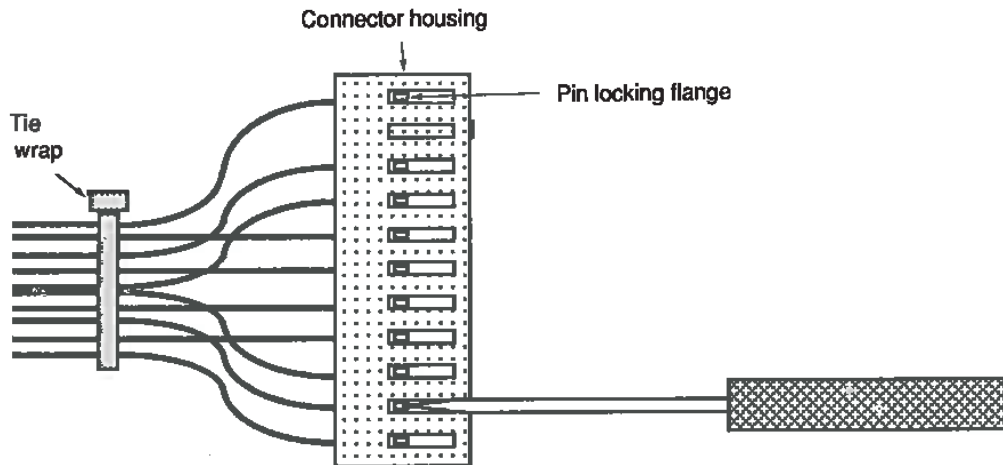

Figure 7-14 Slip the pins out of the socket by pressing on the pin locking flanges with a small screwdriver.

AC Boxer Fans

115-V AC boxer fans are also available. The model shown in Figure 7-15 comes premounted. The bracket saddles the disk drive. The fan itself is oriented such that the exhaust blows directly at C24, C29, CR20, and CR21, a major trouble spot. Micro test clips are factory attached, which reduces the installation to a simple nuts and bolts procedure.

Macintosh Installation

1. With the mother board removed and the Mac lying with its screen face down, locate the four screws that attach the internal disk drive cover to the Mac chassis, noting the hole in front of each of the front screws. Remove the two rear screws.
2. Mount the bracket using the two empty holes and the two holes from the removed screws.
3. As shown in Figure 7-10, attach the micro test clips to the top of diodes CR23 and CR24, or to the top of diodes CR24 and CR25, or to the top of diodes CR25 and CR26. All three combinations put the fan directly across the AC line. Any one of the three combinations is fine.

Other Considerations Unlike piezo fans, which are centrally mounted and simply mix the air, boxer fans may be rear mounted to physically exhaust the air. With a piezo fan installed, you won't really notice anything different except your computer will feel cooler when you touch it. With a rear-mounted boxer fan installed, there'll be a steady stream of mechanically driven hot air exiting out the back.

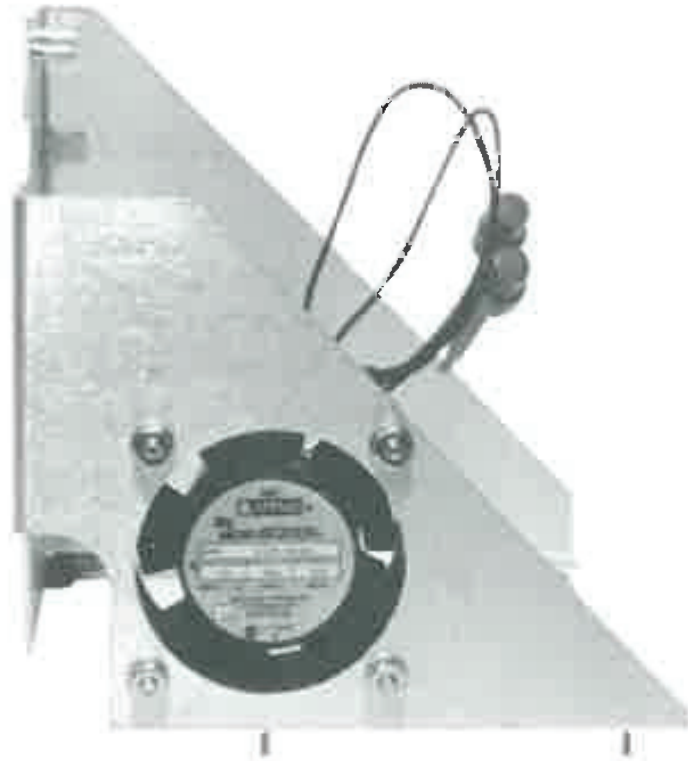

Figure 7-15 This 115-V AC boxer fan comes premounted.

Piezo fans make a buzzing sound, sort of like an electric razor, but much softer. You can't hear the buzz over a hard drive. You'll never hear it in an office, but in the quiet of your own home, it will be noticeable. No worse than a steadily ticking clock, but noticeable. Boxer fans make a whooshing sound. If you own a hard drive that tends to whine, the noise of the boxer fan may actually tone it down. Otherwise, it'll sound just like a small oscillating fan, except the whooshing sound will be steady, because the noise will always be coming from the same direction.

Installing a piezo fan, or an AC boxer fan, is electrically equivalent to plugging something into an outlet all the way across the room. Installing a 12-V DC boxer fan adds an additional 120-mA load on the Mac's power supply. That's a small amount of current, but nevertheless the Mac has to rectify it, filter it, and supply it. Chapter 4 tells how to test the +12-V supply. If it's not up to specification, repairs should be effected before loading it any further with a 12-V DC fan.

Both types of fans (+12-V DC and piezoelectric) work equally well on 220-V AC (European) and 115-V AC (U.S. and Canadian) electrical systems. For use during a dire emergency, a less elegant, but equally effective cooling solution is shown in Figure 7-16.



Figure 7-16 In dire emergencies, external oscillating fans may also be used.

Summary

The failure avoidance strategy states that for any given situation, if you can eliminate all possible causes of failure, then success (in this case reliability) is guaranteed. After five years, it's now obvious that many failures on the Macintosh analog board are heat related. To preclude repeat failures, the failure avoidance strategy suggests that the problem should be attacked from both ends. A heavy-duty power supply upgrade substitutes high-temperature replacement parts for the parts originally specified that are known to fail. A fan upgrade lowers the set's internal operating temperature so the high-temperature replacement parts last even longer. By effecting both solutions, you're also bringing an older computer in line with the latest Macintosh SE standards.

In the next chapter we'll look at another upgrade that's based on the Macintosh SE. We'll show how you can measurably improve the sound quality (128K to Macintosh Plus) simply by adding a speaker grill.

CHAPTER

8

Audio Upgrades

This chapter covers 128K to Mac Plus audio repairs and upgrades. The instructions assume that you've got a working set, that you've made a TPG/System disk, and that you know how to take the back off the set. If necessary, please review Chapters 1 and 2 for specific details.

Audio Repairs

When the sound stops working (128K to Mac Plus) or if you get distorted sound, it usually means trouble with one or more of the following parts:



Audio Symptoms	Solution
1. No sound	Check control panel/replace B1 (analog board) Inspect/insulate RFI shield (part# 805-0577) Check J3 (analog board) Check J4 (analog board) to J7 (logic board) cable Test J1 (logic board) external speaker jack Test/replace OEM speaker (analog board)
2. Scratchy sound	Install accelerator software patches
3. Distorted sound	Test/replace Q2, Q3 (logic board) Test/replace OEM speaker (analog board)
4. Weak sound	Check +12-V and -12-V power supplies Check/replace 7905CT regulator (logic board)

A partial schematic of the audio circuit is given in Figure 8-1. Table 8-1 provides a replacement parts list.

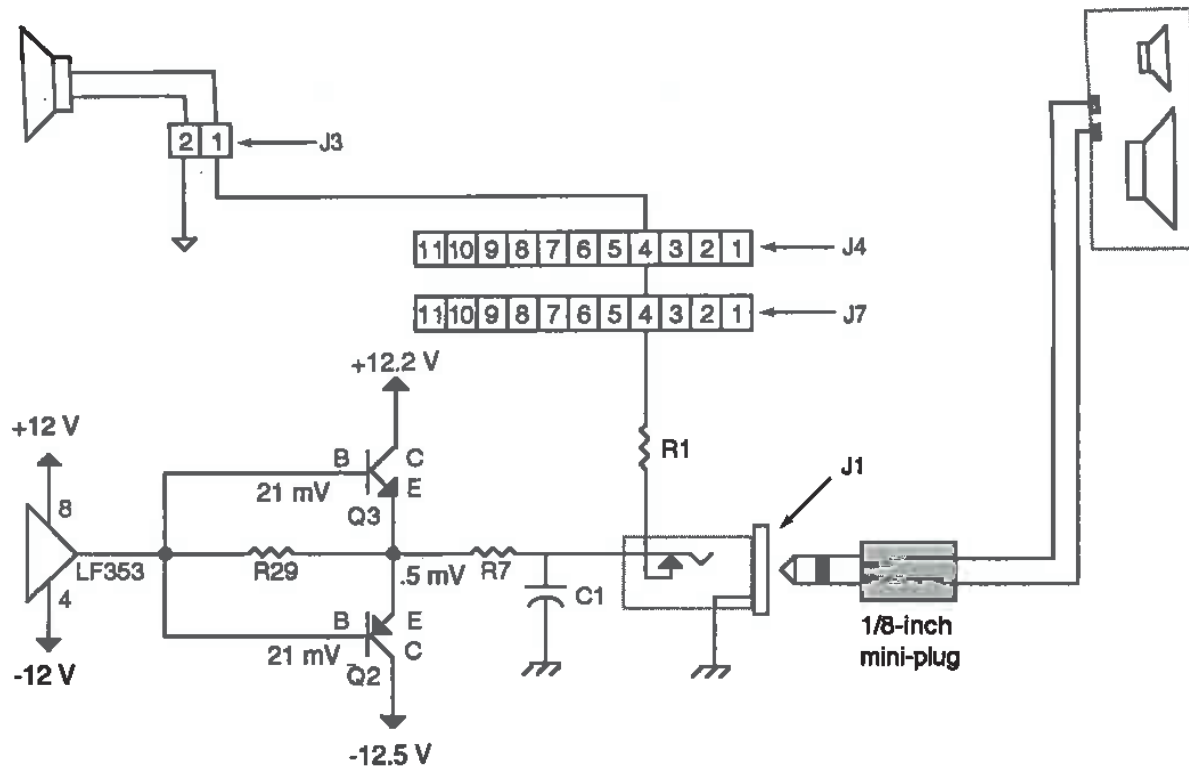

Figure 8-1 Macintosh audio circuit, 820-0086-C logic board.

Table 8-1 Parts List—Macintosh Audio Circuit

Ref.	Generic	Philips	Radio Shack	Description
C1	0.1 mfd	N/A	Not listed	Encapsulated ceramic
B1	4.5 V	N/A	Not listed	Eveready #523 battery
R1	27 Ω	N/A	Not listed	1/4 W, 5%, carbon-film
R27	47 Ω	N/A	Not listed	1/4 W, 5%, carbon-film
R29	150 Ω	N/A	271-1312	1/4 W, 5%, carbon-film
Q2	2N4403	ECG 70	276-2023	Silicon PNP amp, TO-92
Q3	2N4401	ECG282	276-2058	Silicon NPN amp, TO-92
N/A	Speaker	N/A	Not listed	2-inch, 63 Ω , 0.25 W

No Sound

When the sound on a 128K to Macintosh Plus suddenly stops working, the first thing to do is to pull out the Control Panel Desk Accessory (DA) and check the volume setting as shown in Figure 8-2. If there's no Control Panel listed under the Apple menu, shut down, and restart your Mac with an official System disk. Bring out the Control Panel DA, position the mouse pointer over the volume knob, click the mouse button and raise the volume to level 3 or more. When you release the mouse button, the Mac should beep. The louder you raise the volume, the louder it should beep. If it does, that proves the amplifier circuit is fine.

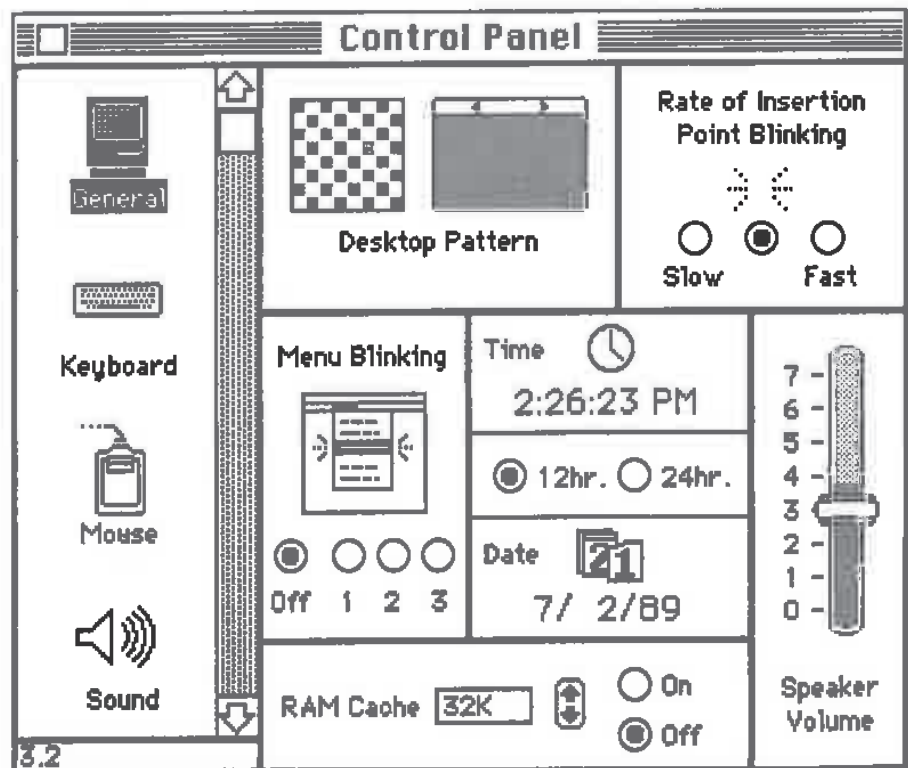

Figure 8-2 Macintosh Control Panel Version 3.02.

If the problem recurs after you switch off the power, and no one else could possibly have lowered the volume in the meantime, check the 4.5-V clock battery. It's located in a small compartment just above the power switch. This battery not only runs the clock but also supplies power to an area of memory where the volume setting and other Control Panel information is stored. In service, it lasts three to four years. Replacement is part of routine maintenance. Note that it's not necessary to open the Mac in order to change the battery.

Inspect/Insulate RFI Shield (Part# 805-0577) If the battery is fine and it's not the Control Panel volume setting, chances are that the RFI shield (part# 805-0577) is shorted to J1, the external speaker jack at the back of the computer. As shown in Figure 1-9, the RFI shield is a 9-inch long piece of *conductive*, aluminum-colored material which fits over the I/O (input/output) connectors (the mouse, disk drive, printer, modem, and speaker ports) on the logic board. On the 128K to 512Ke, the shield has a gentle bend. If you're not careful to maintain that bend when working on the computer, you can easily create one or more unwanted short circuits between the shield and the logic board. In the case of J1, audio output goes to ground instead of through R1.

To check for this problem, reopen the Macintosh and examine the RFI shield. It should be perfectly smooth. If you notice scratches or dimples in the metal, that's where it was touching the solder joints underneath J1. Generally, there's no permanent damage. Insulate the shield with clear, 2-inch wide, package sealing tape, and you'll never have this problem again.

Check the Connectors Another cause of no sound is a disconnected speaker. On some analog boards, the speaker wires plug loosely into a jack at location J3. The wiring is held in place by a dab of sealant, but if the Mac is frequently transported, the plug can still work itself loose. The permanent fix is to remove the jack, cut off the plug, and solder the speaker leads directly to the analog board.

A variation on this problem is a loose or tarnished J4 (analog board) to J7 (logic board) harness. Check for a bad crimp on the inner yellow wire or for corrosion on pin-4. Treat it the same as the unstable voltage condition described in Chapter 4.

The next most likely problem is a sprung or corroded external speaker jack. On a Macintosh Plus, the external speaker jack (J1) is located at the back of the computer to the left of the mouse connector. On the 128K to 512K Macintosh and the Macintosh SE, the external speaker jack is located at the back of the computer to the right of the modem connector. To unspring the jack, insert a 1/8-inch mini plug and rotate it through one or two complete revolutions. If the contacts are corroded, that action may scratch them enough to reestablish the connection. If not, you can either replace the jack or substitute an external speaker as shown in Figure 8-3.

Test/Replace the OEM Speaker If none of the connectors is at fault, suspect an open internal speaker. The stock speaker is riveted to the analog board on the left side of the Macintosh. To test it:

1. Make sure the power cord is physically disconnected from the wall outlet.
2. Open the Macintosh according to the instructions in Chapter 1.
3. Switch on your digital multimeter and set it to read K-ohms. Analog meters should be set to the R \times 10 scale and zeroed.



Figure 8-3 External speaker connections for the Macintosh Plus.

4. Touch the red probe to one of the speaker terminals and touch the black probe to the other.
5. Observe the reading. In-circuit, the OEM speaker should read 59 to 63 Ω . If the speaker reads infinity, the voice coil is open, and the part will have to be replaced.

Contrary to popular belief, it's not necessary to use an exact replacement 0.25-W, 63- Ω speaker. 2-W, 8- Ω replacement speakers work fine. Not only that, but they're a lot louder! You can also substitute a 4- Ω , or a 16- Ω speaker. Here's the rule: In a given application, as the impedance of a loudspeaker goes down, the power rating of the voice coil has to go up. Otherwise, you may burn out the part. In this case, 63 Ω (OEM specification) + 8 Ω (replacement specification) = up by a factor of 7.875. 0.25-W (OEM specification) \times 7.875 increase = 1.97-W power rating for the 8- Ω replacement speaker. By the same formula, if you were to use a 16- Ω speaker, it would have to be rated at 1 W. Referring to Figure 8-1, another way to limit the output power is to add more resistance in series with R1. The important point is, you *don't* have to use a 63- Ω speaker as long as you follow the above power guidelines and choose nothing lower than a 4- Ω , 4-W speaker.

To drill out the pop rivets on the original internal speaker, use a hand drill fitted with an $1/64$ -inch (3.7 mm to 4.2 mm) bit. Secure the new speaker to the analog board with 6-32 \times $3/8$ (4-0.7 \times 10 mm) pan-head screws and nuts.

Be sure to insert the screws from the solder side of the board! If you insert them from the component side of the board, the extended threads will interfere with the vinyl jacket and you may not be able to get the cover back on.

Scratchy Sound

Scratchy sound is usually a software problem associated with accelerated Macs. 16-MHz accelerator cards generally require a special INIT file in the System folder. After a while, people with hard drives tend to forget about the INIT. When they start up from a floppy disk, there's a sound problem. When they boot from the hard drive, the sound is fine.

If that's the case, the fix is simple. All you have to do is copy the INIT file from the System folder on the hard drive to the System folder on each and every startup disk. In addition, certain programs like HyperCard may require running a sound patch. Other utilities, like MacinTalk, have to be upgraded to the 16-MHz version. The important point is, that if you've got an older Mac with an accelerator card, scratchy sound is usually not hardware related.

Distorted Sound

Distortion could be the result of a bad internal speaker. To confirm or eliminate that possibility, try plugging an external speaker into the J1 connector at the back of the computer. If the external speaker sounds fine, the internal speaker is bad. If both speakers sound bad, suspect a problem with Q2 and/or Q3. To test them in-circuit, refer to the typical voltages given in Figure 8-1. Bad readings will definitely indicate a problem, but good readings don't necessarily mean anything. Distortion is not that easy to troubleshoot with a multimeter. Since we're talking about less than the cost of a soft drink, just replace both transistors. For general replacement instructions, refer to Chapters 4 and 11.

Weak Sound

Weak sound is generally a by-product of certain memory upgrades. They drag the 12-V supply way down; there's not enough juice left to drive the amplifiers. Check the 7905CT regulator as described in Chapter 6 and/or upgrade the power supply as described in Chapter 7.

Audio Upgrades

This section shows how to use 512K-TPG to sample the sound output of all four Macintosh voices and explains how to use the program to measure

frequency response. With this information, you can test any internal or external replacement speaker, including the loudspeakers attached to a stereo system. To understand how sound is measured, let's review what the terms "sound" and "frequency response" mean.

The Technical Definition of Sound

Sound is the auditory perception of vibrations. By definition, sound implies:

1. A sound maker—a source of vibrations, like falling trees.
2. A medium to transmit the sound—air, water, anything but a vacuum.
3. Sensory organs—ears to perceive the sound!

Remember the question, "If a tree falls in the forest and there's no one there to hear it, will it make any sound?" Scientifically the answer is no. The falling tree would certainly create vibrations, but these would be absorbed by the environment. By definition, without auditory perception, the vibrations would never be heard. If they're never heard, there's no sound. It's as simple as that. Here's how falling trees apply to the Macintosh.

Inside the computer, sound begins as a series of amplified electrical impulses. On the 128K to Mac Plus, these impulses are converted to vibrations by a 63- Ω , 0.25-W, built-in speaker. The quality of the built-in speaker is quite good, but look closely at the left side of the cabinet. There's no speaker grill! Not only is the built-in speaker muzzled, but the cabinet itself is expressly designed to dampen sound. The inside surface is rough and pebbled. As a result, a lot of what might otherwise become sound (the speaker/falling tree's vibrations), never gets out of the box (the forest).

Test Tone Oscillator

You can prove that to yourself by choosing any of the four voice audio tests from 512K-TPG's Aux. menu. As shown in Figure 8-4, that closes all open windows, and brings out Test Tone Oscillator (TTO), TPG's integrated audio program. TTO produces both sine waves and square waves. Sine waves are used for testing the 512K to Macintosh SE. Square waves are provided for testing stock Lisas and Macintosh XL's.

In addition, two user modes are provided. Sweep runs through a preselected series of tones, one after the other. Step runs through the same series of test tones one at a time. Sweep is best for quick audio checks. Step mode is best for taking scientific measurements. Step gives you a chance to observe your instruments between test tones. Under MultiFinder, you can enter and plot your data all at the same time by running a spreadsheet program simultaneously.

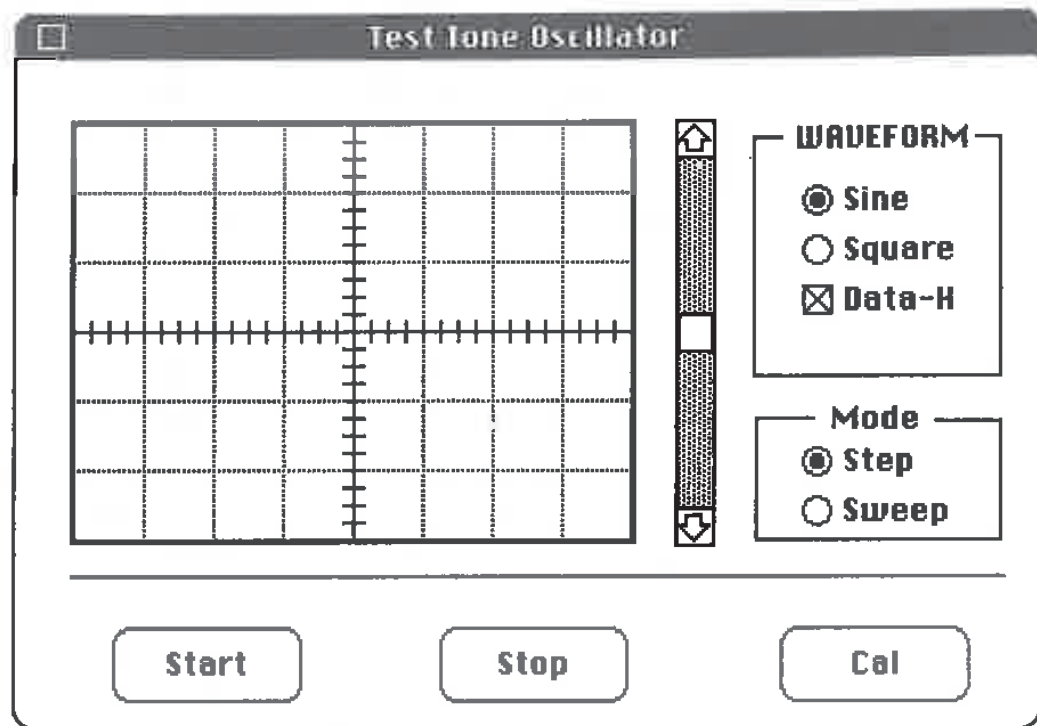

Figure 8-4 Test Tone Oscillator, 512K-TPG's integrated audio program.

Verifying Accuracy TTO is quite accurate. By connecting the external speaker jack directly to a frequency counter, you can easily verify that the test tones fluctuate no more than ± 1 Hz. In other words, given a 100 cycle test tone, TTO's output frequency may vary between 99 Hz and 101 Hz. Given a 1,000 cycle test tone, the program's output frequency may fluctuate between 999 Hz and 1,001 Hz. Plus or minus one hertz accuracy is comparable to lab instrumentation costing hundreds of dollars. Of course, as a friend of mine pointed out, the Macintosh costs thousands of dollars—it ought to be *at least* that accurate!

Measuring Frequency Response In a laboratory environment, loudspeakers are placed in an anechoic (without echoes) chamber, test tones are generated (with a test tone oscillator), and precise measurements are taken (with a sound level meter) over a wide range of frequencies. At home, you can use a living room, a Macintosh running 512K-TPG, and an ordinary tape deck. Any cassette or reel-to-reel model with a microphone input and at least one analog meter should work fine. The testing procedure involves just six simple steps:

1. Set up the tape deck, plug in the microphone, and engage the record mode.
2. Start the Macintosh and launch 512K-TPG.
3. Choose one of the four voice audio tests from the Aux. menu. This brings out Test Tone Oscillator.
4. Click the Cal button and calibrate the tape deck's record level meter for +3 VU (Volume Units). The Cal button sounds a 1000 cycle test tone for 10 seconds. If necessary, you can click the Cal button a second or a third time until you get the meters perfectly adjusted.
5. Click the Step radio button (if necessary) to engage the Step mode.
6. Click the Start button to begin the test. Observe the recorder's VU meters and jot down the results. To continue with the next tone, follow the instructions at the top of the display.

Figure 8-5 shows a typical frequency response chart. Figures 8-6 and 8-7 show how to format the data using Microsoft Works so you can create your own charts. Note that Figure 8-5 shows two frequency response curves. The lower curve indicates stock 128K to Macintosh Plus frequency response. The upper curve shows the difference that adding a speaker grill makes.

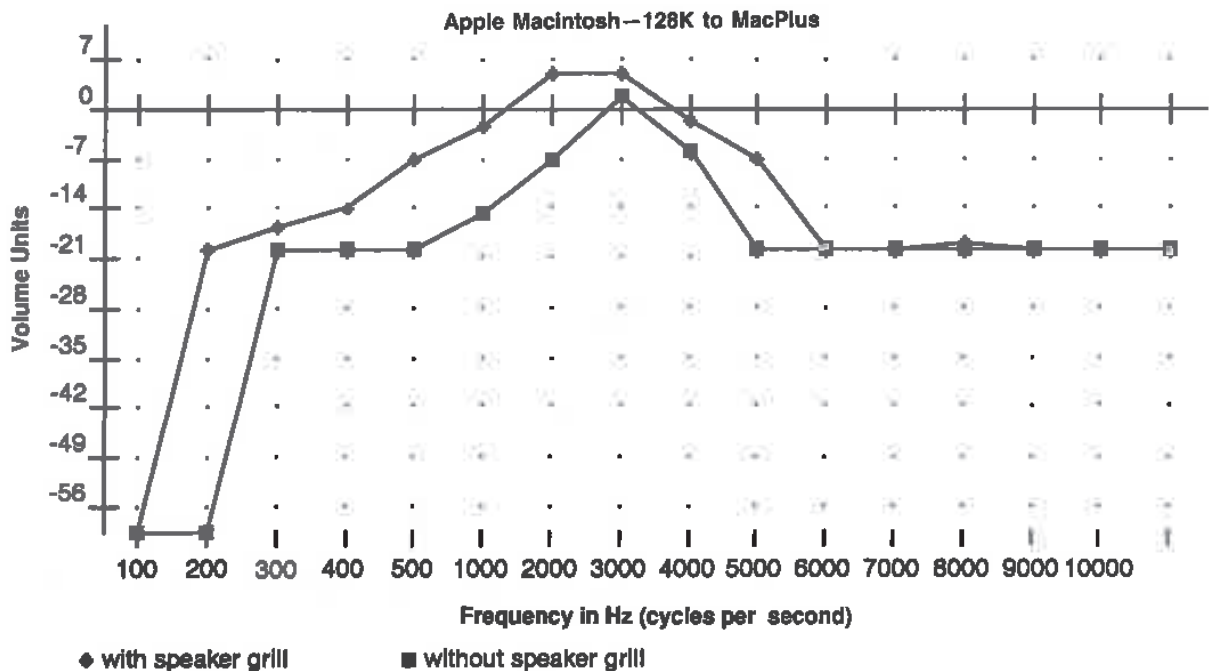

Figure 8-5 Microsoft Works chart indicates 128K to Macintosh Plus frequency response before and after adding a speaker grill.

Frequency Response (SS)											
	A	B	C	D	E	F	G	H	I	J	K
1	frequency	100	200	300	400	500	1000	2000	3000	4000	5000
2	with speaker grill	-60	-20	-17	-14	-7	-2.5	5	5	-1.5	-7
3	without speaker grill	-60	-60	-20	-20	-20	-15	-7	2	-6	-20
4											
5											
6											
7											
8											
9											
10											
11											
12											
13											
14											
15											
16											
17											
18											

Figure 8-6 To make your own charts, arrange VU data in rows 2 and 3. Note that the test frequencies start in column B and occupy the first row. Chart labels start in row 2 and occupy the first column.

Type of Chart:			Values to be Plotted:			Vertical Scale:			
<input checked="" type="radio"/>		LINE	1st Row:	2		<input checked="" type="radio"/>	Numeric		
<input type="radio"/>		BAR	2nd Row:	3		<input type="radio"/>	Semi-Logarithmic		
<input type="radio"/>		STACK	3rd Row:			Maximum:			
<input type="radio"/>		COMB	4th Row:			Minimum:	0		
			From Column:	B		<input checked="" type="checkbox"/>	Draw Grid		
			To Column:	Q		<input checked="" type="checkbox"/>	Label Chart		
			Data Legends in Column:	R					
			Horizontal Titles in Row:	I					
			Chart Title:	Apple Macintosh - 128K..Mac Plus					
			Vertical Scale Title:	VU					
			Horizontal Scale Title:	Frequency in Hz (cycles per second)					
						Cancel	Plot It!		

Figure 8-7 Use this chart definition for a graph similar to Figure 8-5.

Adding a Speaker Grill

As shown in Figure 8-8, 512K-TPG provides a full-sized template for adding a speaker grill to the left side of your Macintosh (128K to Mac Plus).

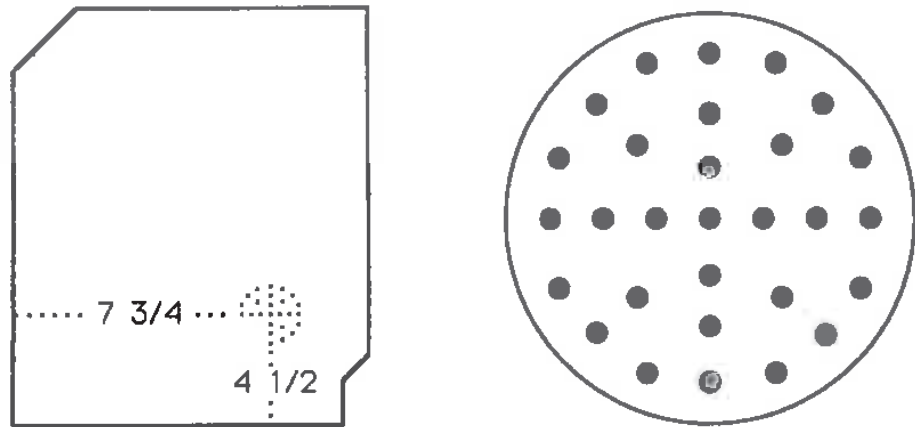

Figure 8-8 512K-TPG provides a full-sized template for adding a speaker grill to the left side of your Macintosh. The center of the internal speaker (128K to Mac Plus) is located approximately $7\frac{3}{4}$ -inches in from the back and $4\frac{1}{2}$ -inches up from the bottom.

To print a copy of the template:

1. Launch 512K-TPG and choose Macintosh Speaker Grill from the Reference menu.
2. Load the printer with paper and turn it on.
3. Choose Page Setup... from the File menu. Make sure 100% Size (no reduction) is in effect. Click the Tall Adjusted button for use with an ImageWriter. Check the "Exact Bit Images (Shrink 4%)" option for use with a LaserWriter. Click the close box.
4. Choose Print... from the File menu. Confirm the number of copies, and click the OK button.

Once you've printed or photocopied the template, follow these steps to install the grill:

1. Open the Macintosh as explained in Chapter 1, and measure the left side of the case as shown in Figure 8-8. The center of the internal speaker is located approximately $7\frac{3}{4}$ inches in from the back and $4\frac{1}{2}$ inches up from the bottom. Put a mark at that point.
2. Cut out the grill template with a pair of scissors and poke through the unfilled center hole with a pencil tip.
3. Locate the template on top of your mark and stick the template down with 2-inch wide, package sealing tape. If you use $\frac{1}{2}$ -inch wide, cellophane

tape, be sure to use lots of tape—enough to completely cover the template. Tape adds strength and keeps the template from tearing under the drill bit.

4. The recommended drill bit size is $\frac{1}{8}$ -inch. You can use a hand drill, but unless you have extremely steady hands, it's best to use a drill press. Note that the Macintosh case is deceptively thick ($\frac{5}{32}$ inch). Use a block of scrap wood and adjust the milling table so that the drill bit penetrates at least $\frac{1}{4}$ inch into the wood.
5. Carefully drill out the holes one at a time.
6. Remove the tape, vacuum the shavings, and reassemble the case.

Don't allow yourself to be tricked by the $\frac{5}{32}$ -inch thickness of the Macintosh case. The first time I tried this, some of the holes did not go all the way through. Since it's difficult to drill two holes in exactly the same spot, even with a drill press, the redrilled holes resemble ovals more than they do circles. Oval holes work fine, the defect is strictly cosmetic, but the uneven pattern suggests an amateur job. Take the time to set up properly, and your work can be perfect.

Remeasuring Frequency Response Once you've drilled out the grill and reassembled the covers, you'll be ready to take a second set of frequency response measurements. On startup, the first thing you'll notice is that the Macintosh is now 50% louder. Instead of bong!, you should hear BONG!

If you want the after-graph to show that volume enhancement, skip the calibration procedure. Don't readjust the meters. If you *don't* want the after-graph to show the volume enhancement, *be sure* to recalibrate the meters. Recalibrating to +3 VU reduces the recorder's input sensitivity, which offsets the increased volume.

Comparing Results Don't expect your results to match Figure 8-5, exactly. That's impossible. In the laboratory, curves are obtained with money-is-no-object instrumentation in an anechoic chamber. In the home, floor coverings, furnishings, and even the clothes on your back will affect results. Also, the characteristics of your particular recorder and /or your particular microphone may introduce dips or peaks into the curve. For all of these reasons, expect results that are relatively similar to Figure 8-5, but not necessarily identical.

Adding an External Speaker

Adding a speaker grill has several advantages. It's a pleasurable workshop project. It doesn't cost any money, and it significantly improves the sound. It also keeps your Macintosh 100-percent transportable because the grill doesn't take up any desk space. If none of that's important to you, then consider

adding an external speaker. Almost anything, loose car stereo speakers, even bookshelf speakers from a broken down home stereo can make a tremendous difference. The internal speaker on a 128K to Mac Plus, for example, cannot reproduce 100 cycles. Many external speakers can.

To find out which is the best external speaker for your Macintosh, run Test Tone Oscillator. In fact, with Test Tone Oscillator and an assortment of cables, you can use the Macintosh to gauge the frequency response of any loudspeaker. You'll need a cable with an 1/8-inch mini plug to alligator clips for loose speakers; a cable with an 1/8-inch mini plug to stripped ends for bookshelf speakers, and a cable with an 1/8-inch mini plug to RCA phono plug for other applications. Car stereo speakers can usually be driven directly from the Macintosh. Less efficient home stereo speakers may need to be amplified. In that case, use the 1/8-inch to RCA phono cable and plug the Mac into the AUX jacks of an amplifier. Connect the speaker to the amplifier, adjust the amplifier's volume control for normal listening, then run the program's calibration tone. Except for adjusting the amplifier's volume control, the testing procedure is exactly the same.

The Effects of Magnetism What about magnetism? Isn't any external speaker likely to have a big magnet and doesn't that pose a threat to data? How far do you have to keep external speakers from floppy disks? How far should they be placed from hard disks? In an attempt to answer these questions once and for all, obtain a loose loudspeaker (a car stereo speaker is fine,) and set up the following magnetism experiment:

1. Turn the speaker face down on a table so that the magnet faces up.
2. Initialize a blank disk and copy some familiar data to it. You can copy a favorite program, a file, TPG, anything at all. Just make sure it's a copy, not the original data.
3. Hold the disk an inch or so above the magnet and pretend the magnet is a bulk tape eraser. Move the disk back and forth, up and down, around and around, right side up and upside down, in a straight line, in a circular motion, do your best to erase the disk.
4. Stick the magnet to the disk shutter. Leave it overnight. Leave it for a week!
5. When you're absolutely sure that you've erased the data, start your Macintosh and try reading the disk. It'll be fine!

I've conducted this experiment (for friends and associates) countless times. Even after subjecting the test disks to static eliminator guns and color TV degaussing coils, we've never erased a single byte. Not with 3.5-inch Mac disks, not with 5.25-inch PC disks. You won't either.

The danger posed by small speaker magnets has been greatly exaggerated. The 2-way, 4- Ω external speaker shown in Figure 8-3 is the one I use. Select something similar, exercise reasonable caution, and you won't have any trouble.

CHAPTER



Video Upgrades

This chapter covers 128K to Macintosh SE video upgrades. Several do-it-yourself projects are described, including:

1. Enlarging the display.
2. Installing an antiglare CRT.
3. Building and installing a TTL video adapter.

Plus, the use of antiglare magnification screens is covered, and full details are given on the selection and connection of PC-style external monitors.

At this point, the instructions assume that you've got a working set, that you've made a TPG/System disk, and that you know how to get the back off the set. If necessary, please review Chapters 1 through 4 for specific details.

Display Enlargements

In Chapter 2 we learned that the screen on a 9-inch Macintosh (128K to Mac SE) contains 175,104 luminous dots called pixels. There are 512 pixels across the screen and 342 pixels from top to bottom. According to specifications, each pixel is supposed to measure exactly $\frac{1}{72}$ inch, so 72 pixels should equal 1 inch. To determine the correct width, divide 512 by 72 and the result is exactly 7.11 inches. To determine the correct height, divide 342 by 72 and the result is exactly 4.75 inches.

When the set is adjusted this way, what you see on the screen is exactly what you get on paper. To prove it, print anything (using Tall Adjusted mode

if you have an ImageWriter) and hold up the printed copy to the screen. It should look like a photocopy. Everything should line up perfectly. All text and graphics should start and stop in exactly the same spots.

WYSIWYG (what you see is what you get) screen alignment is perfect for desktop publishing and just what the draftsmen ordered for forms design. But it's completely irrelevant if what you primarily do is process words and data. In that case, you want to widen the display as far as it can go, to enlarge the characters and minimize eyestrain.

Maintaining Linearity

Linearity refers to the degree that squares actually look like squares, and circles look like circles. To maintain linearity when enlarging the display, you have to know the width-to-height ratio. On the standard 9-inch Macintosh, the width-to-height ratio is 1.497 ($512 \div 342$). Since the maximum available screen width on a 9-inch Macintosh is 7.375 inches, the correct height dimension to match with that width is 4.927 inches ($7.375 \div 1.497$).

Advantages

Enlarging the display to 7.375 inches wide by 4.927 inches high nets a 4% improvement in width ($7.375 \div 7.11 = 1.037$), a 4% improvement in height ($4.927 \div 4.75 = 1.037$), and an 8% overall improvement. The WYSIWYG display only measures 33.7725 square inches (7.11×4.75). The enlarged display area measures 36.3366 square inches (7.375×4.927); $36.3366 \div 33.7725 = 1.0759$, or in round figures, an 8% improvement. 8% is a lot! Entire labor forces have gone on strike for much less.

If you've been working with a shrunken display, the improvement is even greater. Due to the effects of heat and old age and improperly installed memory upgrades, older displays shrink to approximately 6.875 inches by 4.5 inches. The area on an older display is reduced to approximately 30.9262 inches (6.875×4.5). Enlarge *that* to 36.3366 inches and you're talking about a whopping 17% ($36.3366 \div 30.9262 = 1.1749$) improvement.

Other Considerations

The complete display adjustment procedure is given in Chapter 3. To enlarge the display, follow the exact same instructions given there, but adjust for 7.375 inches \times 4.927 inches instead of 7.11 inches \times 4.75 inches.

If the set is in poor condition, you may not be able to focus the corners of the enlarged display area. The crosshatch may also reveal bending at the corners. Both problems can easily be corrected by installing the power supply upgrade described in Chapter 7.

If you have more than one 9-inch Macintosh, be careful about mixing display sizes. After looking at the enlarged display, WYSIWYG displays

seem disturbingly small. Shrunken displays become completely intolerable. It's been my experience that the mind adapts to whatever size you use the most, and changing to a smaller size can be traumatic. Often, the cause of the trauma is physical. The SE I'm working on at this very moment has a fully enlarged (7.375×4.927) display. Generally, I can use it without putting on my glasses. If I try that on a WYSIWYG (7.11×4.75) display that I use for forms design, I soon get a headache. If I persist, I also get a backache and neckache, presumably from leaning forward too much. They say that necessity is the mother of invention. For me, an 8% improvement is exactly what the doctor ordered.

Antiglare Magnification Screens

If you need more than an 8% improvement, consider an antiglare magnification screen. Typical Macintosh models consist of a Fresnel magnification lens and a Polaroid brand antiglare filter. Both are cut to size and mounted in a light-weight plastic frame.

Installation

As shown in Figure 9-1, installation begins with sticking a small bracket on the top of your Macintosh with double-sided foam tape. Next, you slip an adjustable hanger arm through the bracket to support the frame, then you insert a matching standoff into the bottom of the frame to keep it from swinging. The initial setup and installation takes about 60 seconds. Afterwards, you can remove and rehang the screen as often as you wish in less than two seconds. That's a good feature. If you remove and store the screen (in a drawer) at the end of the day, you'll still be able to cover your Mac with a standard size computer cover.

Advantages

Polaroid brand antiglare screens are just about 100% effective in eliminating glare which originates from behind the operator. If you sit with your back to a window or a lamp, and reflections glare off your screen, install one of these and the glare will be gone.

Reflections which come from behind the computer are another story. Due to the hanger design (which provides adjustment needed for the magnification lens), these are not dispersed. Light entering from the rear gets trapped. If you sit facing a window, you'll need to fashion some kind of visor or there'll be new glare on the back of the screen. For a quick visor, try a file folder draped across the top.

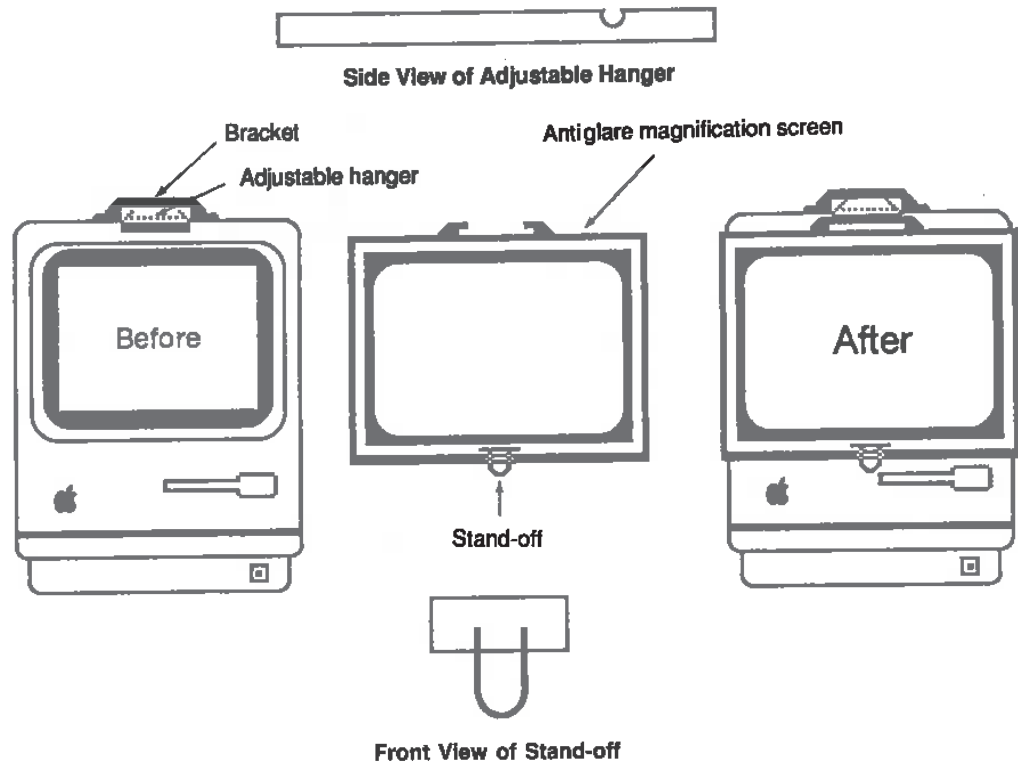

Figure 9-1 Antiglare magnification screen—installation details.

The magnification factor comes from a sandwiched 1.5× Fresnel lens, but on a Macintosh, the normal black border surrounding a WYSIWYG display limits the actual magnification to 1.4×. Here's the math: As explained above, the WYSIWYG display on a 9-inch Mac measures 33.77 square inches (7.11×4.75). On the antiglare magnification screen, the enlarged display measures 47.68 square inches (8.38×5.69). Since $47.68 \div 33.77 = 1.41$, images appear 41% larger when seen through the lens.

Other Considerations

Fresnel lenses (named after 19th century French physicist Augustin Jean Fresnel) look something like clear phonograph records. You can see the grooves, and when you sit at the right angle, you can see refracted (colored) light patterns off the grooves. Objects viewed through the lens are somewhat curved. The surface of the Macintosh appears to be a puppet stage and there is a definite sensation of depth. The effect is similar to looking through a personal 35-mm slide viewer and somewhat similar to looking into a swimming pool. You'll either love it or hate it.

Assembled screens weigh 6 oz, about the same as a pocket calculator. Although the combined thickness of the lens and the polarizing filter is less than $\frac{5}{1000}$ inch, the screens are amazingly rigid. You can't poke a pencil

through them like you can with a mesh filter, and they're practically unbreakable. You don't have to worry about dropping these items. The screens are very light, and even if you did drop one, unlike a CRT, it's not going to break.

Cleaning is also no problem. Polaroid recommends specially formulated PolaClear, a two-step, wet and dry towelette, but any lens or glass cleaner can be used. I use soap and tap water and even that works fine. If you ever had a pair of genuine Polaroid sunglasses, or even plastic prescription eyeglasses, you can treat the antiglare screens exactly the same.

In addition to antiglare magnification lens combination products, some firms offer the lens, and/or the antiglare filter as separate products. Some products come with antistatic grounding wires. These wires are superfluous on the Macintosh, since as shown in Figure 1-10, the case is already grounded.

CRT Upgrades

Another way to reduce glare is to use a high-quality antiglare CRT. Not all OEM CRT's are equal. If you have an OEM Samsung model in your Mac, you already have an antiglare CRT. Otherwise, if you've got a Clinton or a Philips CRT, your Mac will probably fail the following test.

Glare Test

In a normally lit room, switch off the Mac and observe the screen. Alternately, you can run TPG, and choose Black Raster or Reverse Video from the Test Patterns menu. Can you see yourself in the screen? Can you clearly see all of the furniture behind you in the screen? If you had an antiglare CRT, none of that would be visible. Even the brightest room lights would be diffused and barely noticeable.

Now the torture test. Shine a strong flashlight on the screen. If you have the usual Clinton or Philips CRT, you'll see two strong reflections. A very bright light will bounce off the surface of the screen. A very clear reflection of the flashlight bulb will appear to be coming from inside the screen.

On the OEM Samsung model, the surface reflection is much softer. The inner reflection is softer still. Specifically, you cannot see the flashlight or the flashlight bulb! This test is particularly revealing when all three OEM CRT's are set up side by side.

With an OEM Samsung CRT, or an after-market Orion CRT, the strain on your eyes is much less. You'll no longer be bothered by light entering from windows directly behind your shoulders. You won't have to keep the shades drawn, and you'll be able to work comfortably for long stretches of time, even with the room lights on.

CRT—Removal and Installation

This section provides the complete CRT removal and installation procedure. Refer to these instructions to install higher quality antiglare CRT's, or to adjust the yoke on existing CRT's. With this information, you can upgrade to an OEM Samsung model and you can even add some color to your Mac by selecting an after-market model with a green or amber screen.

CRT Removal Instructions

1. If the set is on, power down normally and switch off the power.
2. Physically disconnect the power cord from the wall outlet. If you're the least bit hesitant about discharging the CRT, leave the set disconnected overnight. By the next morning, most, if not all, of the high-voltage charge will have dissipated.
3. Remove all rings, watches, and jewelry. Open the case as described in Chapter 1.
4. As shown in Figure 4-15, disconnect the J4 (analog board) to J7 (logic board) cable by pulling straight up.
5. Put on safety goggles. Discharge the CRT through a 10-meg resistor as shown in Figures 1-13 to 1-15.
6. As shown in Figure 5-16, remove the high-voltage lead coming from the top of the flyback transformer to the anode well of the CRT.
7. Disconnect the J1 (analog board) to CRT (yoke) cable. As shown in Figure 7-4, use a 6- to 8-inch long $\frac{1}{8}$ -inch screwdriver to pry back the connector lock, and pull the wires straight back.
8. As shown in Figure 9-2, loosen the yoke retaining screw with a #1 Phillips-head screwdriver. Alternately, you can use an $\frac{1}{8}$ -inch screwdriver or a $\frac{5}{32}$ -inch screwdriver. Pick one with a 4-inch shaft.
9. As shown in Figure 9-3, gently slip the CRT socket cable off the neck of the CRT. Use a light touch. The neck of the CRT is fragile!
10. Push the disconnected CRT socket cable out of the way, and slip the loosened yoke off the neck of the CRT.
11. Spread out a towel and lay the computer face down. Prepare a padded box for the CRT you're about to remove.
12. As shown in Figure 9-4, the CRT is held in place by four T-15 screws. Remove them using a T-15 screwdriver with an 8-inch shaft. Note the ground wire attached to the upper left screw.

13. Carefully grip the CRT at the edges of the screen. Use two hands to lift it up and out of the way. Pay attention to what you're doing. Never lift any CRT by the neck. If you do, it'll snap and glass may fly all over the place. Better have your goggles on!

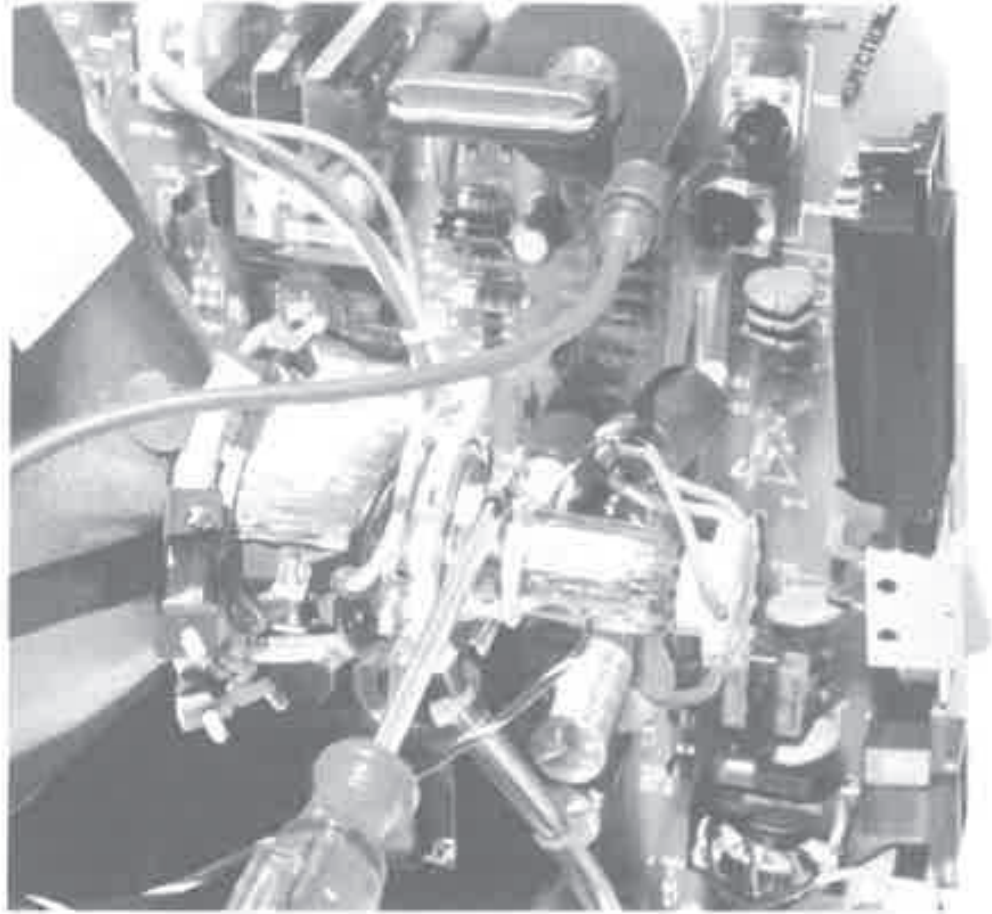

Figure 9-2 Yoke retaining screw—removal details.

14. Carefully place the CRT in the padded box.

Most distributors offer a nominal dud value for the old CRT. You're expected to ship it back in the same box that the replacement CRT comes in. At this point, however, the replacement should still be in its box. That's why you need to set up another one. Not only is it dangerous to accidentally knock over your old CRT, but you'll lose the trade-in allowance, and you'll have a big mess to clean. Set up a holding box!

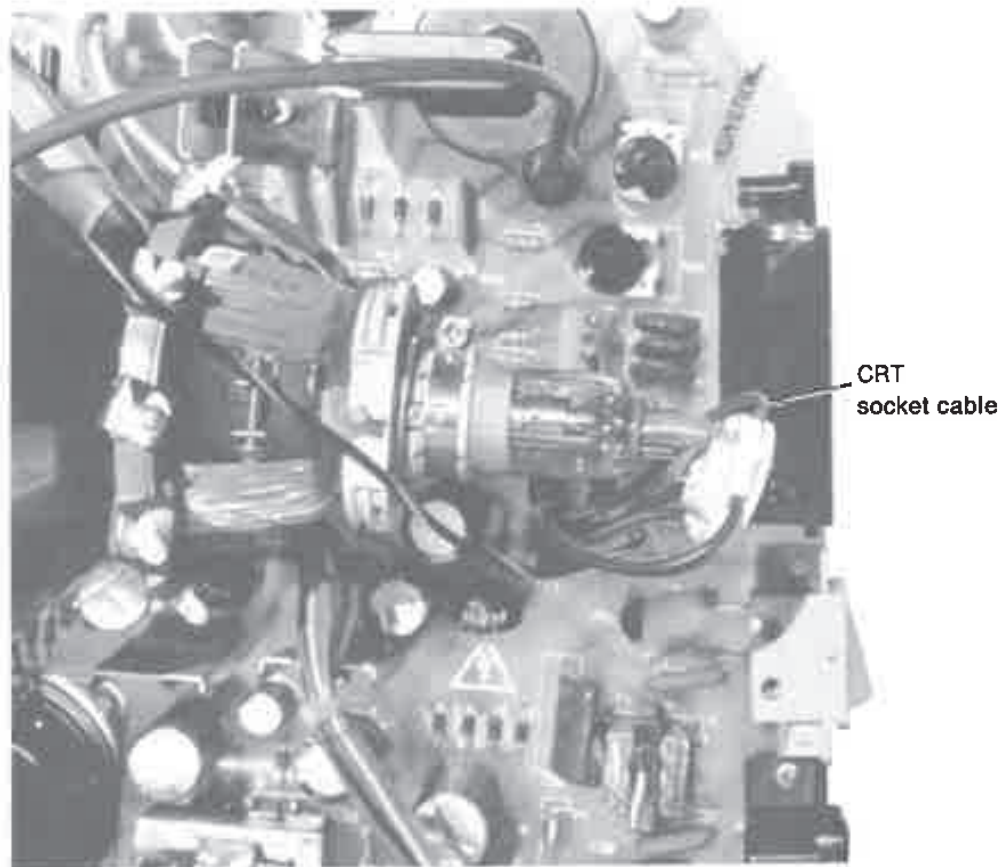

Figure 9-3 CRT socket cable—removal details.

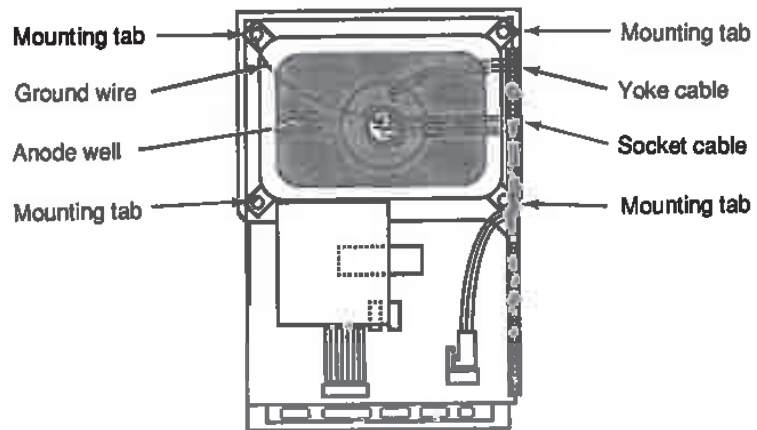

Figure 9-4 CRT mounting details.

CRT Installation Instructions

1. Remove all rings, watches, and jewelry. Put on safety goggles.
2. Carefully unpack the new CRT.
3. Using two hands, transfer the new CRT to the computer. Set it in place. Orient the new CRT such that the anode well is on the left. If you orient it such that the anode well is on the right, the display will be upside-down.
4. Mount the new CRT using the same four screws that held the old CRT. Remember to attach the ground wire to the upper left screw.
5. Slide the yoke assembly as far as it'll go onto the neck of the CRT. Snug the yoke retaining screw, but don't tighten it yet! You want the screw snug enough to hold the yoke in place but still loose enough to allow adjustment. Hold the screwdriver between your thumb and forefinger to limit torque.
6. Plug the CRT (yoke) to J1 (analog board) cable into J1. The connected cable helps keep the loose yoke from slipping.
7. Reattach the CRT socket cable. Gently slide the socket all the way home on the neck of the CRT.
8. As shown in Figure 5-16, reconnect the high-voltage lead coming from the top of the flyback transformer to the anode well of the CRT.
9. Carefully stand up the computer. Plug the J4 (analog board) to J7 (logic board) cable into J7.
10. Reconnect the power cord and switch on the computer. It's not necessary to boot. Observe the screen. If there's any foldover around the edges as illustrated in Figure 9-5, it means the yoke is too far back. Using only one hand, fix it by gently sliding the yoke up onto the neck as far as it will go. **Never use two hands when working around the CRT.** Always keep one hand safely behind your back or put it in your pocket.
11. Still using only one hand, rotate the yoke such that the raster is square to the frame. When the edges look fine and the raster is square, gently tighten the yoke retaining screw. Hold the screwdriver between your thumb and forefinger to limit torque.
12. Realign the video (the height, width, centering, and so on) as explained in Chapter 3.
13. Choose Control Panel from the Apple menu. Use the Control Panel dialog box to reset the time, the date, and other preferences.

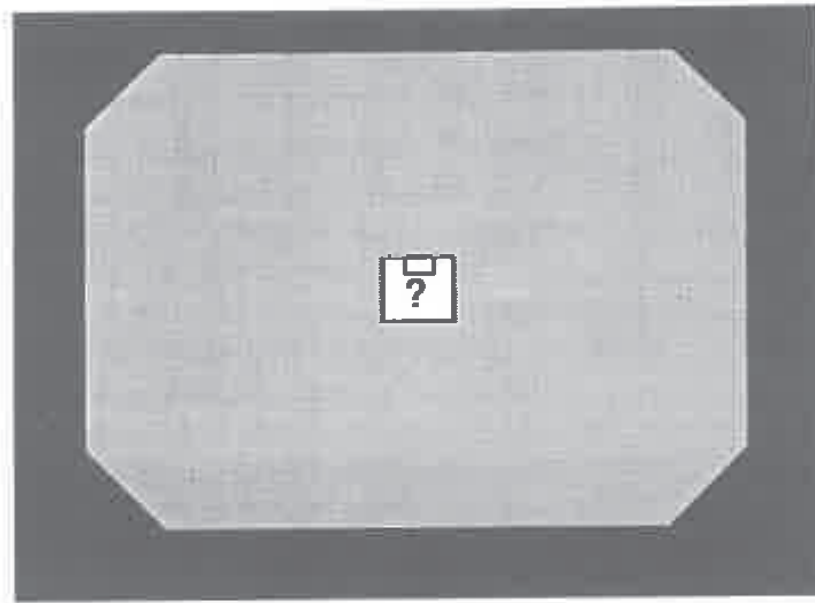

Figure 9-5 This kind of foldover means the yoke is too far back.

Building a TTL Video Adapter

Another way to reduce glare and enlarge the display is with a PC-style (TTL) external monitor. External PC monitors come in all shades of amber, green, and white and usually contain CRT's measuring 12 to 14 inches diagonally. The built-in Macintosh CRT measures only 9 inches diagonally. Properly set up and adjusted, an external monochrome monitor can make a big difference.

Using PC-style (TTL) monitors requires a TTL video adapter. The next section shows how to build one from scratch. Table 9-1 provides a parts list for the project. Figure 9-6 provides a wiring diagram.

Table 9-1 Parts for TTL Video Adapter

Qty.	Ref.	Description
1	C1	.01-mfd 50-V ceramic capacitor
1	U1	74LS14 IC
1	N/A	Miniature printed-circuit board
1	N/A	14-pin IC socket
1	N/A	12-inch length of 20-AWG stranded blue wire
1	N/A	12-inch length of 20-AWG stranded green wire
1	N/A	12-inch length of 20-AWG stranded orange wire

Table 9-1 (cont.)

Qty.	Ref.	Description
1	N/A	12-inch length of 20-AWG stranded white wire
1	N/A	18-inch length of 9-wire ribbon cable
1	J9	DB9S IDC connector
2	N/A	4-inch nylon wire ties
4	N/A	1/2-inch nylon feet
4	N/A	1/2-inch squares of double-sided foam tape

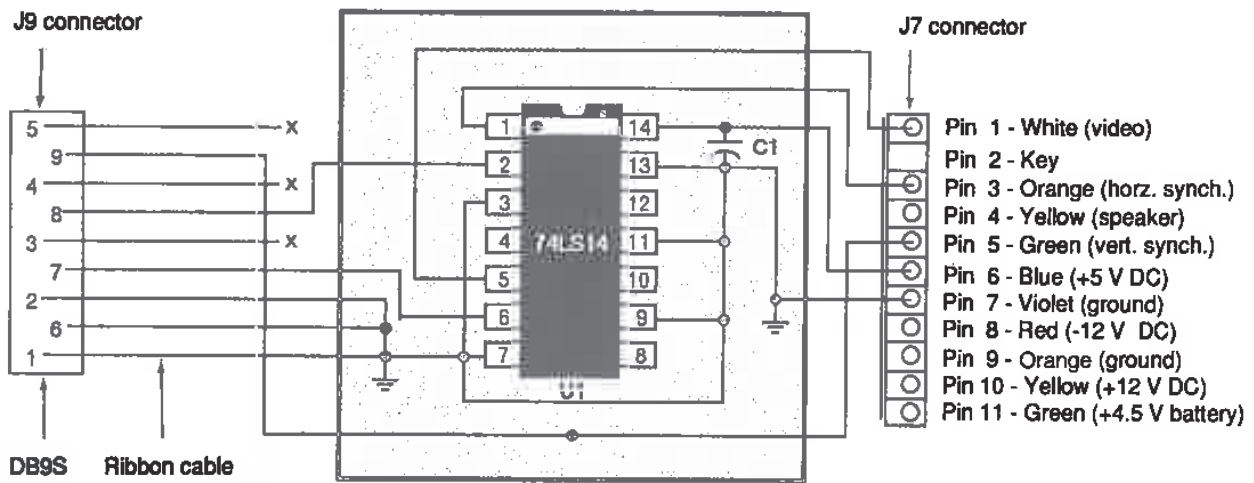

Figure 9-6 Wiring diagram for TTL video adapter.

Construction Notes

Start by disconnecting the J4 (analog board) to J7 (logic board) cable. Cut the tie wrap at the J4 end of the harness to loosen the wires, then as illustrated in Figure 7-14, slip pins 1, 3, 5, 6, and 7 out of their sockets by pressing on the pin locking flanges with a small screwdriver.

First push the wires forward to free the locking flanges from the connector housing, then, as you press down on the flanges, pull the wires straight back. It's not necessary to completely remove the wires from the connector. All you have to do is expose a little pin metal so that you can tack on tinned extension wires.

Tack on 12-inch lengths of stranded 20-AWG wire and slip the pins back into the connector housing one at a time.

Since there's no mechanical connection on a tacked solder joint, it's very important to tie-wrap the extensions to the main harness. The tie wraps provide strain relief which helps to keep the joint intact.

Lay out the circuit as best as possible and wire everything to the IC socket according to the diagram. Figure 9-7 gives the pin out detail of an Insertion Displacement Connector (IDC). Note that ribbon cable wire numbers alternate. They are not numbered in sequence!

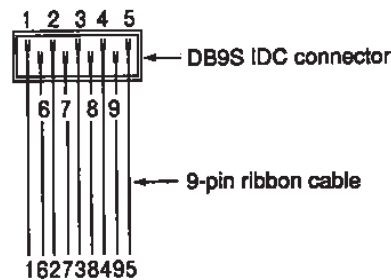

Figure 9-7 Numbering details for DB9S IDC connector.

If you can't find 9-pin ribbon cable, use 20-pin cable and slice it to size with a razor knife. Laid flat on a board, ribbon cable slices easily, and the leftover piece can be sliced again to make another length of 9-pin cable. Note that the recommended 18-inch length is very important. If you substitute a shorter length, it'll be very difficult to snake the IDC connector through the rear cabinet when it's time to reassemble everything.

You can buy a special tool for attaching IDC connectors, but an ordinary shop vise works fine. In either case, you only get one shot, so line up the wires carefully before you squeeze.

Make sure that your point-to-point wiring skirts the IC socket. If you wire across the socket, over the socket, or too close to the socket, it'll be very difficult to plug in the IC.

As shown in Figure 9-8, mount the finished board on top of the internal disk drive with double-sided tape and 1/2-inch nylon feet. Be careful not to lay the board itself on top of the metal disk-drive bracket, or you'll create a dead short.

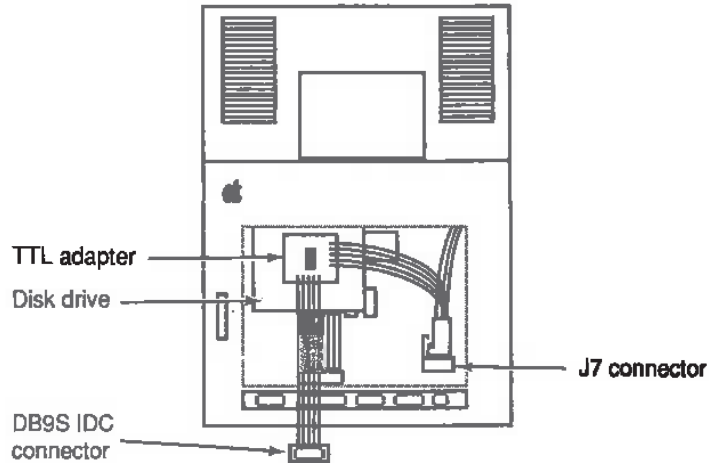

Figure 9-8 TTL video adapter—mounting detail for 128K to Mac Plus.

Troubleshooting

On power up, the Macintosh should bong and the usual floppy disk icon with the blinking question mark should appear. If the set bongs, but you don't get a display, check the front-panel brightness control setting. If that's not it, shut down and check the J4 connector to make sure pin-1 (composite video) is properly seated. Next check the other end of the white wire where it connects to the TTL adapter.

A horizontal problem suggests something wrong with the orange wire or J4 pin-3. A vertical problem suggests something wrong with the green wire or J4 pin-5. Flapping noises would indicate a dead short on the blue wire (+5.00 V) attached to J4 pin-6.

Assuming that the Macintosh behaves normally, try plugging in a TTL monitor before putting the set back together. If you can get the picture to synchronize on the external monitor by adjusting the monitor's rear panel vertical controls, that means the adapter is OK. The picture may not be very large and it may be distorted, but without readjusting the monitor's internal controls, that's to be expected. Snake the DB9F IDC connector through the Mac's battery opening or through one of the lower I/O openings. Low exit points are generally preferable because high exit points interfere with standard size computer covers. Whichever exit you choose, get the computer completely reassembled before moving on to the next step!

External Monitor Adjustment

Off the shelf monochrome monitors are normally factory set to PC specifications and need to be readjusted for top performance on the Macintosh. Table 9-2 tells the story.

Table 9-2 Video Specifications—Monochrome PC vs Mac

Video Specification	Monochrome PC	Macintosh	Lisa 2/Mac XL
Horizontal sweep	18.432 kHz	22.25 kHz	22.90 kHz*
Vertical sweep	50 Hz	60.15 Hz	60
Horizontal resolution	720	512	720
Vertical resolution	348	342	364

*The latest Lisa 2 and Macintosh XL Owner's Guides both specify 22.90 kHz. The earlier Lisa 1 Hardware Manual alternately lists the same specification as either 22.40 kHz or 22.70 kHz.

When operating outside of its normal specification, each PC-style (TTL) monitor model gives a different result. Some models work better than others. Some don't work at all, until you make minor component changes.

If the monitor is going to work without having to change components, adjusting the rear panel vertical hold control will synchronize the display (stop it from rolling) immediately. Adjusting the vertical height control will expand the display all the way to the top immediately. At this point, you'll have an extra tall Mac display with a larger than average black border to the left and right.

Horizontal width (H-Size) controls are generally inside the set. Open the set, find the H-Size control and adjust it with the same plastic hex tool used to adjust L2 on the Macintosh analog board.

Since the horizontal resolution of a PC-style monitor (720 dots) is so much greater than the horizontal resolution of the Macintosh (512 dots) it's generally not possible to recover full screen width strictly by adjusting the H-Size control. Without substituting replacement components in the width circuit (this is easy, but varies from monitor to monitor), most displays can only be expanded to 7 ³/₈ inches just like the Macintosh. The big advantage is in the readily available extra height combined with an external vertical size (V-Size) control. When you need WYSIWYG, simply cut back the height to 4.92 inches. For normal data and word processing, turn it back up to 6.375 inches. With an external V-Size control, it's no harder than adjusting the volume on a car radio.

Other Considerations

The ideal PC-style/Mac monitor, then, has:

1. An antiglare (flat) CRT to minimize glare.
2. A swivel base to minimize neck strain.
3. Externally mounted synchronization controls to simplify setup.
4. An external V-Size control to simplify WYSIWYG adjustments.
5. An easily disassembled cabinet.
6. An internal width control to maximize horizontal size.
7. A bundled schematic to simplify circuit modifications.

Expansion to full screen width (if necessary) can generally be achieved by modifying the H-Size and H-Linearity control circuit. If the result is off center to the left or displays horizontal foldover, adjust the H-Center and H-Phase controls. If there's no H-Phase control, you may be able to compensate by off centering the screen to the right, or by shrinking the display a little.

Another specification to watch is bandwidth. The industry standard is 20 MHz, but typical monochrome monitors range from 17 MHz to 25 MHz. Generally, the higher the bandwidth, the better the results are going to be.

Finally, some PC-style external monitors are prone to ghosting. TPG's ghost test will reveal that instantly. All things considered, if the monitor ghosts, it should be avoided.

Summary

There's a common law tenet that a product has to be suitable for the purpose to which it's intended. Organized VDT (video display terminal) users are contending that computer screens, which are widely known to cause eyestrain, neckaches, backaches and headaches, are not suitable for the purpose to which they're intended. Although the Macintosh has the sharpest and clearest (OEM) screen of all, the upgrades discussed in this chapter address two common complaints, reflective glare and small display size. With an enlarged, antiglare internal display, or with a carefully selected external monitor, both problems (as well as several others) simply disappear. In the next chapter we'll show how to address another common complaint—not enough memory.

CHAPTER

10

Disk Drive, RAM, ROM, and SCSI Upgrades

This chapter covers disk drive, RAM, ROM, and SCSI upgrades. Arranged chronologically, it shows how to take an original 128K Macintosh to 512Ke Plus (SCSI) status, and it shows how to take a stock Macintosh Plus all the way to 4Mb.

At this point, the instructions assume that you've made a TPG/system disk, that you've got a working set, and that you know how to get the back off the set. It's also assumed that you know all about multimeters and that you've had prior soldering experience. If necessary, please read Chapters 1–4 for specific details.

128K to 512K Logic Board Upgrades

All 128K to Mac Plus logic boards are mounted on metal rails. Other than the analog to logic board (power/video) and the disk drive to logic board (disk drive data) cables, there's no mechanical connection. Once you get the back off the set and disconnect both cables, the logic board slips right out as shown in Figure 10-1.

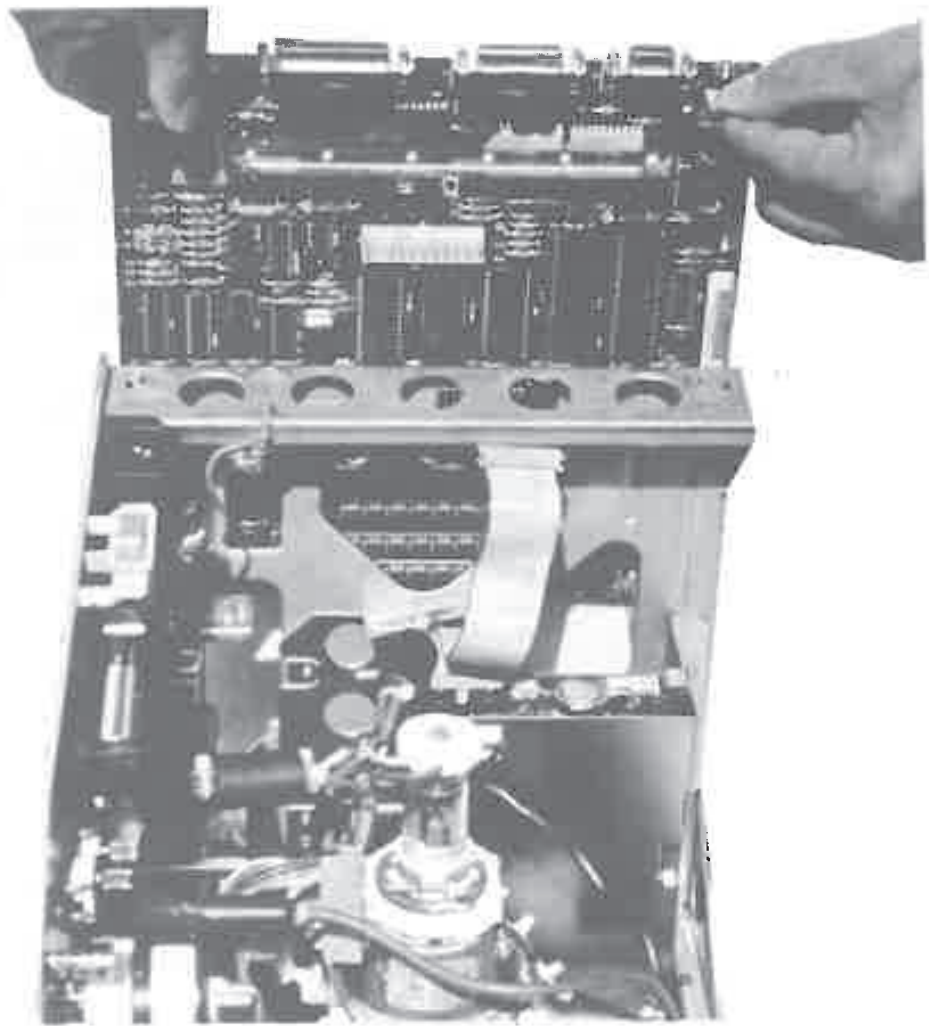

Figure 10-1 Logic board removal.

Board Level 128K to 512K RAM Upgrades

The OEM 128K to 512K upgrade involves a simple board swap. You pull out the old board as shown in Figure 10-1 and replace it with an upgraded board or with a new board. Unofficially, you also have to adjust the +5.00-V supply and the video circuitry as explained in Chapter 3.

Conscientious board level upgrades can take an hour or more because the adjustment procedure often reveals other problems. These should be taken care of at the same time. For details, refer to Chapter 4. Assuming there are no other problems, OEM board swaps take only about 15 minutes.

Component Level 128K to 512K RAM Upgrades

As illustrated in Figures 10-2 to 10-3, there are two models of the 128K logic board. The easiest way to tell one from the other is by reading a part number stamped at grid locations G8 to G12. Early models bear part number 820-0086-C. Later models bear part number 820-0141-A. Since there are major differences between the two models, the component level upgrades vary. In addition, because the original RAM on both boards is soldered, not socketed, both upgrades are labor intensive. Allow yourself at least four hours to complete either project at the component level.

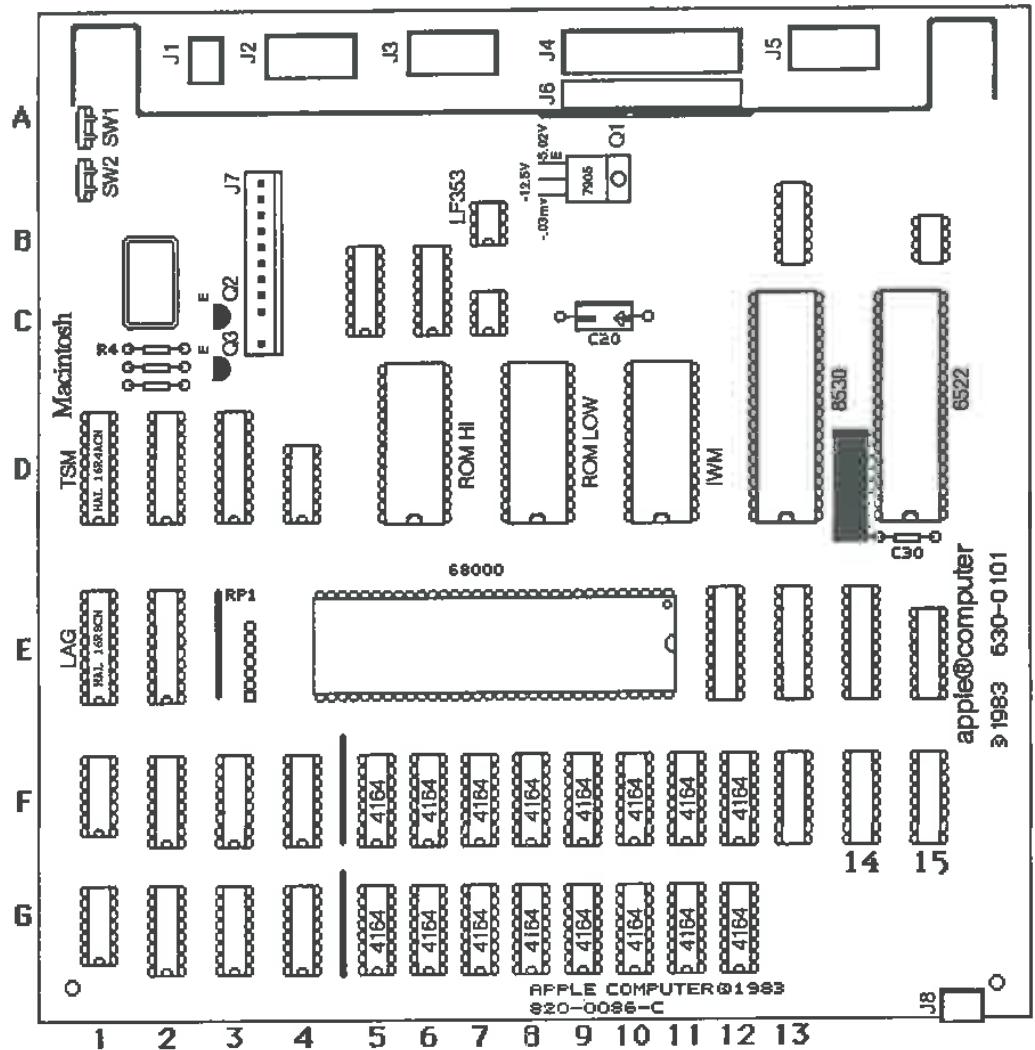

Figure 10-2 Early models of the 128K logic board bear part number 820-0086-C. Courtesy of Sophisticated Circuits, Inc.

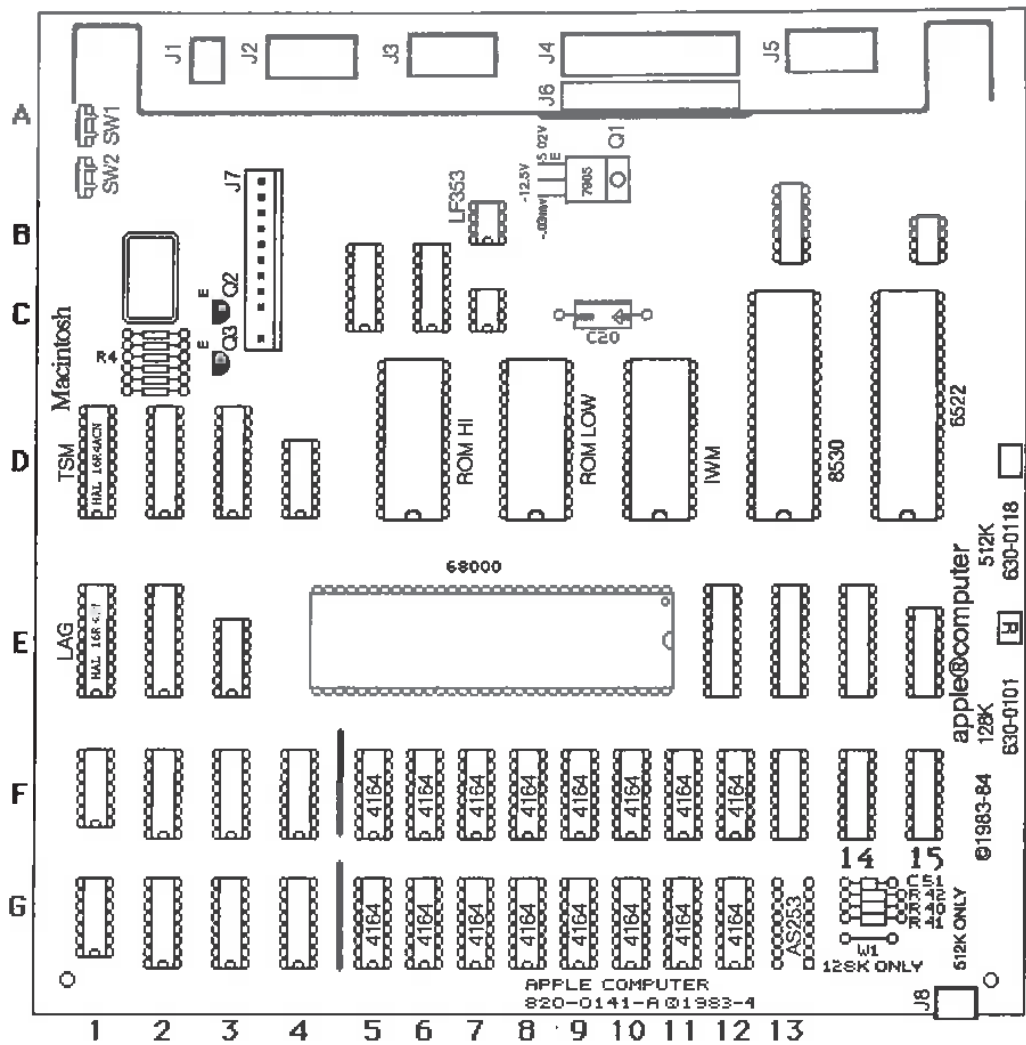

Figure 10-3 Later models of the 128K logic board bear part number 820-0141-A. Courtesy of Sophisticated Circuits, Inc.

Upgrading Model 820-0086-C Logic Boards

This upgrade involves checking for the presence of a resistor network (installing one if necessary), replacing 16 RAM chips, installing a mini-mux. (miniature multiplex) circuit board, and cutting a trace. Table 10-1 provides a parts list.

Table 10-1 Parts List for Upgrading Model 820-0086-C (128K) Logic Board to 512K

Qty.	Item	Ref.	Description
1	Resistor network	N/A	TRW 8428 810-1-222G for 6522
1	Mini-mux. board	N/A	Custom for this application
16	41256 16-pin ICs	N/A	150 or 200-ns 256K RAM chips
16	16-pin DIP sockets	N/A	Optional, for new RAM chips

As illustrated in Figure 10-2, original model 820-0086-C logic boards should be checked for the presence of a resistor network on the 6522 VIA (Versatile Interface Adapter) chip. The earliest boards lack the resistor pack. Without it, the Mac tends to lock up. Installation, if necessary, is part of the upgrade.

The mini-mux. circuit board provides logic needed to decode the extra RAM. Mux. boards could be built from scratch, but since they're cheap enough, it's generally easier to buy them ready-made.

If you already have them, 200-ns (nanosecond) chips will be fine. Otherwise, procure 150-ns chips. They're faster, and believe it or not, the difference does seem to be noticeable. Don't bother with anything faster than 150 ns. Depending on other factors, they may or may not work on a 128K board.

IC sockets are optional but strongly recommended. If the OEM boards had been socketed in the first place, upgrading to 512K would only require half an hour instead of half a day.

With all that in mind, here's the complete component level upgrade procedure, liberally summarized with permission, from SCI's Mac's-a-Million (memory upgrade) owner's manual:

128K to 512K Upgrade Procedure for 820-0086-C Logic Board

1. Locate the sixteen 4164 64K RAM chips illustrated in Figure 10-2 at grid locations F5 to F12 and G5 to G12. Find their counterparts on the actual 820-0086-C logic board. Mark all 16 chips for removal. Use a fast-drying brightly colored nail polish. The idea here is to make absolutely sure that you don't cut away the wrong chip.
2. Use a pair of wire cutters to cut off all 16 terminal pins on all 16 of the RAM chips. As illustrated in Figure 10-4, cut the terminal pins as close to the chip bodies as possible. Since there are 16 pins on each of the 16 chips, this step involves making 256 cuts!

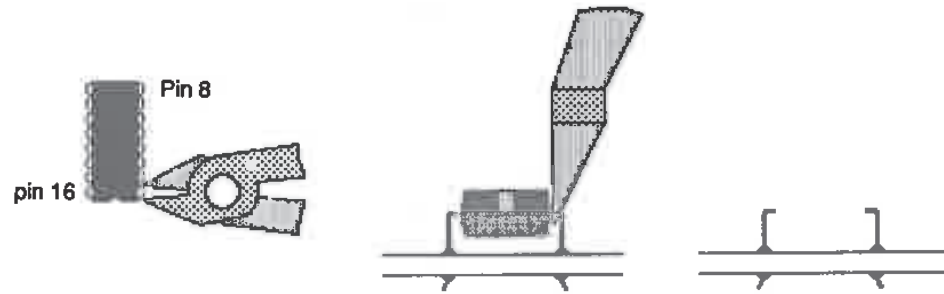

Figure 10-4 4164 RAM chip removal details. *Courtesy of Sophisticated Circuits, Inc.*

3. Mount the logic board in a bench vise.
4. Use needle-nosed pliers to pull each pin from the component side of the board while you heat them from the solder side of the board with a grounded, 15-W soldering iron. Pins 8 and 16 are connected to the inner board layers and consequently require more time to desolder than the others. Some technicians prefer to skip these pins the first time around because it disturbs their rhythm. If you skip them, you'll have to make two passes. In the first pass, desolder pins 1–7 and 9–15 on all 16 of the chips. In the second pass, desolder pins 8 and 16 on all 16 of the chips. For reference, remember that IC pins are numbered counterclockwise as shown in Figure 9-6. The numbering starts from a dot or indentation at one end of the chip.
5. Once all 256 pins have been removed, use a vacuum desoldering tool to completely clean the solder from all 256 holes. Set up a coffee can for the waste solder. Clean the O-ring frequently as shown in Figure 10-5.
The O-ring seals the vacuum chamber. When waste solder accumulates around the edges, air gets by the seal, which reduces suction.
6. Once all 256 holes have been cleaned, examine the area around each hole with a magnifying glass. Check for pads lifted from the PC (printed-circuit) board, breaks between the pads and traces, cut traces near a pad, and solder bridges between the pads and traces. These errors are illustrated in Figure 10-6 courtesy of SCI.

If examination reveals a short on the component side of the board, desolder the socket, remove the solder causing the short, and solder in a new socket. If you find any missed joints on the solder side of the board, solder the loose pins to close the circuit. Lifted pads are more difficult to repair. The pads on a layered board don't just lie on the surface, like they do on the analog board. They're soldered to a small metal grommet connected to the inner layers. Reconnecting a lifted pad often means cutting into the board, which involves delicate electronic surgery.

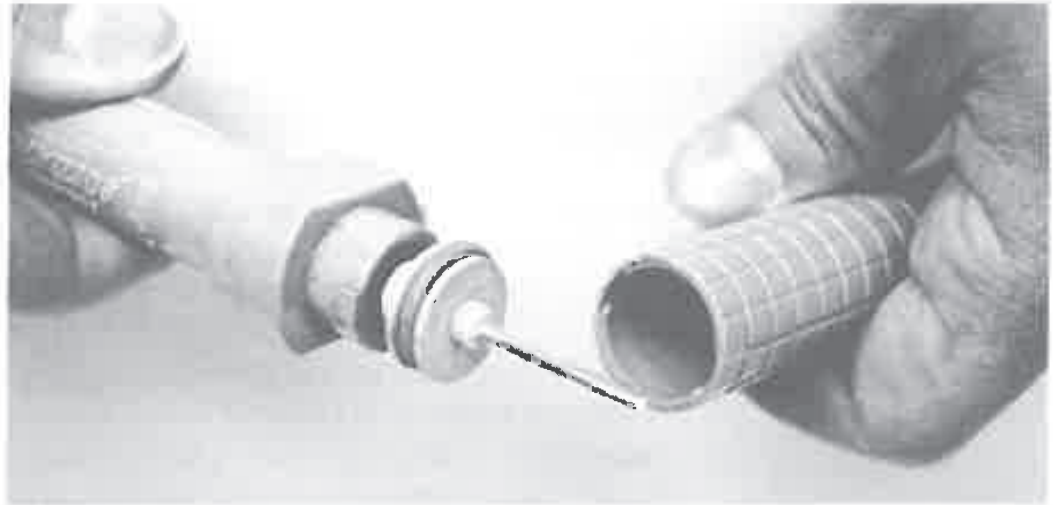

Figure 10-5 Vacuum desoldering tool. The O-ring seals the vacuum chamber. When waste solder accumulates around the edges, air gets by the seal, which reduces suction.

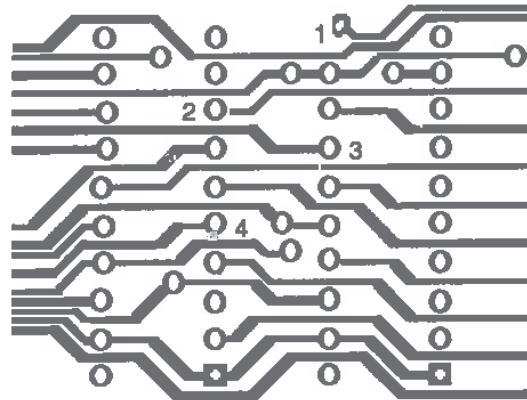

Figure 10-6 Typical soldering errors:
 1. Pad lifted from the PC board.
 2. Break between a pad and its trace.
 3. Cut trace near a pad.
 4. Solder bridge between a pad and a trace.
Courtesy of Sophisticated Circuits Inc.

7. When you're satisfied with the desoldering job, turn the board so that the component side is facing down. Reach under the board and insert a 16-pin DIP socket into grid location F5. Make sure the notched end of

the socket is facing towards the front edge of the board. The notch should be facing *away* from the I/O connectors.

8. Solder pin-1 to the square pad first, and then solder pin-9 in the diagonally opposite corner. To avoid burning your fingers, keep them off the end being soldered.
9. Once the diagonals are down, solder the remaining pins. To keep them from shorting against the metal coating inside the Macintosh case, trim the new joints (if necessary) to the same length as the other joints on the board.
10. Repeat steps 7-9 for each of the remaining 16-pin DIP sockets. Mount them in locations F6 to F12 and G5 to G12.
11. When all 16 sockets have been soldered, clean up the work area and spread out a 2-foot square piece of aluminum foil. The foil is an added precaution against static discharge.
12. When the foil is ready, remove the board from the vise and carefully lay it down so that the solder side is directly on top of the foil.
13. Put on an antistatic wrist strap. Carefully plug one 41256 RAM chip into each socket, making certain each time that the notch is pointing away from the I/O connectors. Be certain all of the pins go into the sockets correctly. It is easy to bend a pin under but can be very hard to find a bent pin, so be careful and take your time!
14. With the new RAM chips in place, you're essentially right back where you started. You've still got a 128K machine because you haven't added the extra logic necessary to decode the extra RAM. Before continuing, it's a good idea to make sure everything still works exactly the same as before. Gently slide the logic board back into the sheet metal grooves. Reconnect the disk-drive data cable and power/video cable. Slide the back cover on, leaving a small gap so that it will come off easily. Reconnect the AC line cord, and switch on the power. If you hear a bong and see the familiar disk icon with a blinking question mark, everything is OK; proceed to the next step. If you get a sad Mac icon with an error code underneath as shown in Figure 10-7, something is wrong; refer to the troubleshooting procedure at the end of this section.



Figure 10-7 Sad Mac icon. Courtesy of Sophisticated Circuits, Inc.

15. Assuming that the Mac powered up normally, shut down, and disconnect the power cord. Remove the back case. Disconnect the power/video cable and the disk-drive data cable. Remove the logic board and place it on the aluminum foil with the component side down.

The following instructions apply to older style 820-0096-C logic boards, only. If you have a newer style 820-0141-A logic board, skip to step 16a, in the next section.

16. Refer to Figure 10-2. Check for the presence of a resistor network on the 6522 VIA chip. If you find one, skip to step 17. Otherwise, use a vacuum desoldering tool to clean the solder from pins 23, 24, 25 and 26 on the 6522 chip and also from the top of C30. Insert the resistor network into the desoldered holes, bend the body over 60 degrees so that it's relatively flat to the logic board (not standing straight up), and solder everything back together as shown in Figure 10-8.

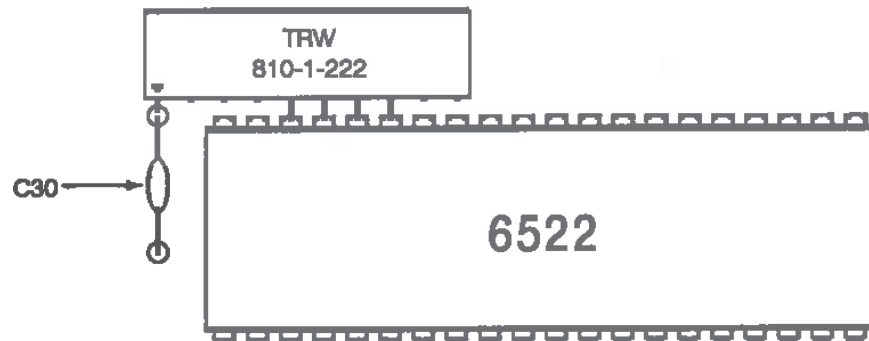

Figure 10-8 6522/resistor network modification details.
Courtesy of Sophisticated Circuits, Inc.

17. Using a vacuum desoldering tool, clean the unused component holes at grid reference E3. Orient the mux. (multiplexer) board according to the supplier's instructions and solder it into place.
18. Carefully cut the trace between pads 1 and 2 at location E3 on the bottom side of the mother board. For reference, pad 1 is the square pad.
19. Reassemble everything but don't replace the rear cover screws. Switch on the Macintosh and insert a System/Finder disk. Confirm 512K status by choosing About the Finder from the Apple menu. The total installed memory is revealed in the resulting dialog box as shown in Figure 2-2.

20. Finish up by adjusting the +5.00-V supply and the video circuitry as explained in Chapter 3.

Upgrading Model 820-0141-A Logic Boards

This upgrade involves replacing 16 RAM chips, adding a chip, cutting a jumper, and adding four small parts to the logic board. More work is involved, but since this board was made to be upgraded, *all* of the necessary parts are readily available. Table 10-2 provides a shopping list.

Table 10-2 Parts List for Upgrading Model 820-0141-A (128K) Logic Board to 512K

Qty.	Item	Ref.	Description
16	41256 16-pin IC's	N/A	150 or 200-ns 256K RAM chips
1	74F253 16-pin IC	N/A	Dual 4-in mux. 3-state
17	16-pin DIP sockets	N/A	Optional, for new chips
1	47- Ω resistor	R42	$\frac{1}{4}$ -W, 5%, carbon film
2	2.2-k Ω resistors	R40-41	$\frac{1}{4}$ -W, 5%, carbon film
1	0.1-mfd capacitor	C51	50-V, encapsulated ceramic

Steps 1-15 are exactly the same as in the previous procedure. Begin by executing steps 1-15 above, then follow steps 16a-24a below.

Continuation Procedure for 820-0141-A Logic Boards

- 16a. Using a vacuum desoldering tool, clean the 24 unused holes at grid references G13 and G14. These holes are marked AS253, C51, R42, R40, and R41.
- 17a. When you're satisfied with the desoldering job, reach under the board and insert a 16-pin DIP socket into grid location G13. Make sure the notched end of the socket is facing toward the front edge of the board. The notch should face *away* from the I/O connectors.
- 18a. Solder pin-1 to the square pad first, and then solder pin-9 in the diagonally opposite corner. To avoid burning your fingers, keep them off the end being soldered.
- 19a. Once the diagonals are down, solder the remaining pins.
- 20a. Reach under the board and insert R40-41 into their respective locations. Electrically, resistor orientation doesn't matter, but for a professional looking job, try to aim the gold-striped ends the same as the other resistors on the board. Bend each pair of leads 45 degrees as shown in Figure 4-13.
- 21a. Reach under the board and insert C51 into its location. Bend C51's leads 45 degrees.

- 22a. Solder R40–41 and C51 into place. Cut off the remaining leads as close to the solder joints as possible.
- 23a. Flip the board over, so that the solder side is directly on top of the foil. Put on an antistatic wrist strap. Carefully plug the new 74F253 chip into the socket, making certain that the notch is pointing away from the I/O connectors.
- 24a. Locate grid reference G-14. Carefully cut away jumper W1, marked "128K ONLY." Make two cuts, so that the leads can't possibly reconnect.
- 25a. Reassemble everything but don't replace the rear cover screws. Switch on the Macintosh, and insert a System disk. Confirm 512K status by choosing About the Finder from the Apple menu. The total installed memory is revealed in the resulting dialog box as shown in Figure 2-2.
- 26a. Finish up by adjusting the +5.00-V supply and the video circuitry as explained in Chapter 3.

Troubleshooting Component Level 128K to 512K Upgrades

When you get a sad Mac icon with an error code underneath, the last four numbers of the error code indicate what the problem is. Although the computer is essentially broken, its built-in diagnostics are still able to tell you exactly what's wrong.

Table 10-3 Sad Mac Error Codes Applicable to the 128K to 512K Component Level Upgrades

Error Code	Meaning	Error Code	Meaning
xx0001	F5	xx0100	G5
xx0002	F6	xx0200	G6
xx0004	F7	xx0400	G7
xx0008	F8	xx0800	G8
xx0010	F9	xx1000	G9
xx0020	F10	xx2000	G10
xx0040	F11	xx4000	G11
xx0080	F12	xx8000	G12

To isolate the problem, simply look up the error code in Table 10-3. Error code xx0001, for example, indicates a problem accessing the chip installed at grid reference F5. Error code xx0100 indicates a problem accessing the chip at grid reference G5.

When there are problems at more than one grid reference, the resulting error code is a combination of two or more individual codes given in the table. Combination codes are easily deciphered by breaking them down. For example, combination code xx0301 is the sum of three individual error codes:

1. Individual code xx0200 indicating grid reference G6
2. Individual code xx0100 indicating grid reference G5
3. Individual code xx0001 indicating grid reference F5

Error xx0301, then, would mean problems involving all three chips. Use an IC-puller to unplug the affected parts. An IC-puller is shown in Figure 10-10. Check for bent-under pins, bent-out pins, and broken-off pins. To repair the faults, use a pin-straightener or a pair of needle-nose pliers. A pin-straightener is shown in Figure 10-12.

It's also possible you could have a bad chip, especially if you worked without taking antistatic precautions. In that case, try substitution. Since chips can be damaged even when you do take antistatic precautions, it's a good idea to order an extra chip in case that happens.

Official 800K Disk Drive/ROM Upgrades

This upgrade involves swapping disk drives and replacing 64K ROM chips with 128K ROM chips. Officially, it turns any 512K Macintosh into a 512Ke (Enhanced) Macintosh.

Disk Drive Removal

After opening the set and removing the logic board, take out the existing 400K drive by removing four chassis screws as shown in Figure 10-9.

Position the new drive over the same four holes, and screw it down with the same four screws. Be careful not to mix up the data cables! As explained below in the unofficial upgrade section, they may be different.

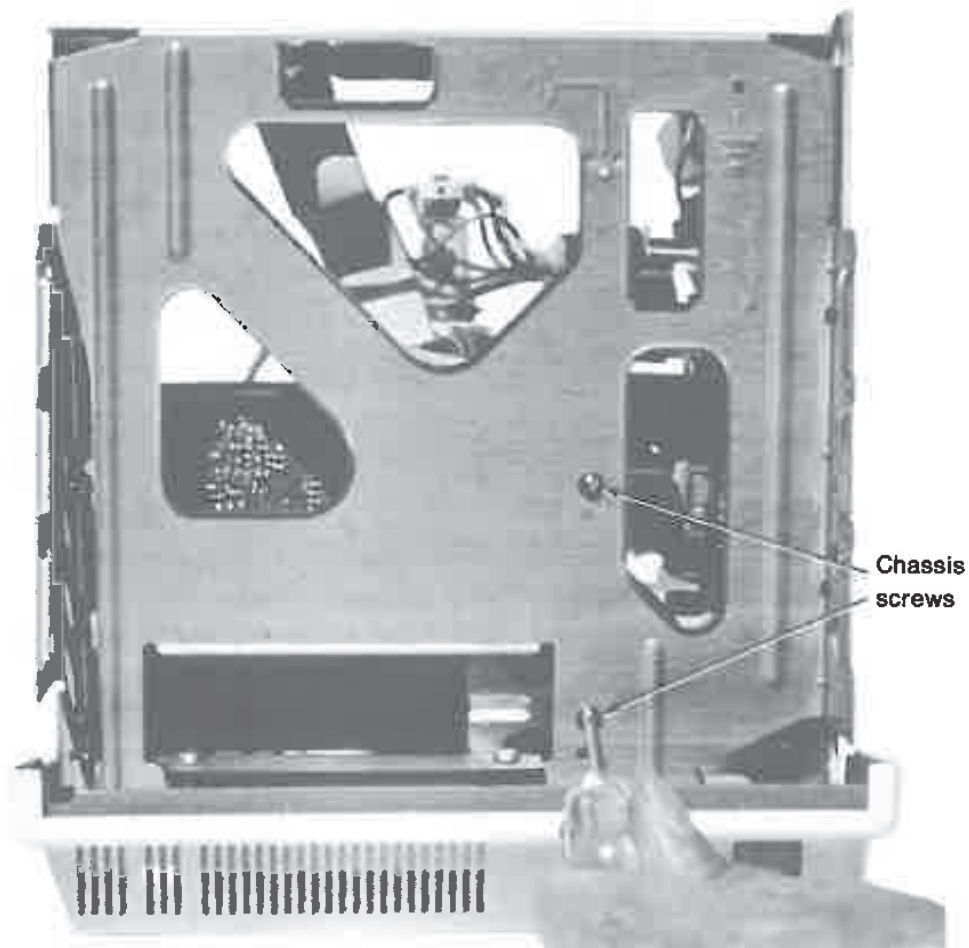

Figure 10-9 400K disk drive removal.

Replacing ROM Chips

As illustrated in Figures 10-2 and 10-3, the existing ROMs are at grid references D5 to D8. Note that there's a HI ROM and a LOW ROM. The HI ROM is always the chip with the lower number. The LOW ROM is always the chip with the higher number. This relationship is easy to remember, because it's exactly the opposite of what you might expect.

Before working on the ROMs, lay a 2-foot square sheet of aluminum foil under the logic board, and put on an antistatic wrist strap. The foil sheet provides extra protection against static electricity. Remove the old ROMs with an IC-puller as shown in Figure 10-10.

Sometimes, the old ROMs freeze to the socket. In that case, it's best to break the ice with a small screwdriver. As shown in Figure 10-11, carefully lift each end of the chip just enough to break the seal, then switch back to the puller, pictured in Figure 10-10, for removal.

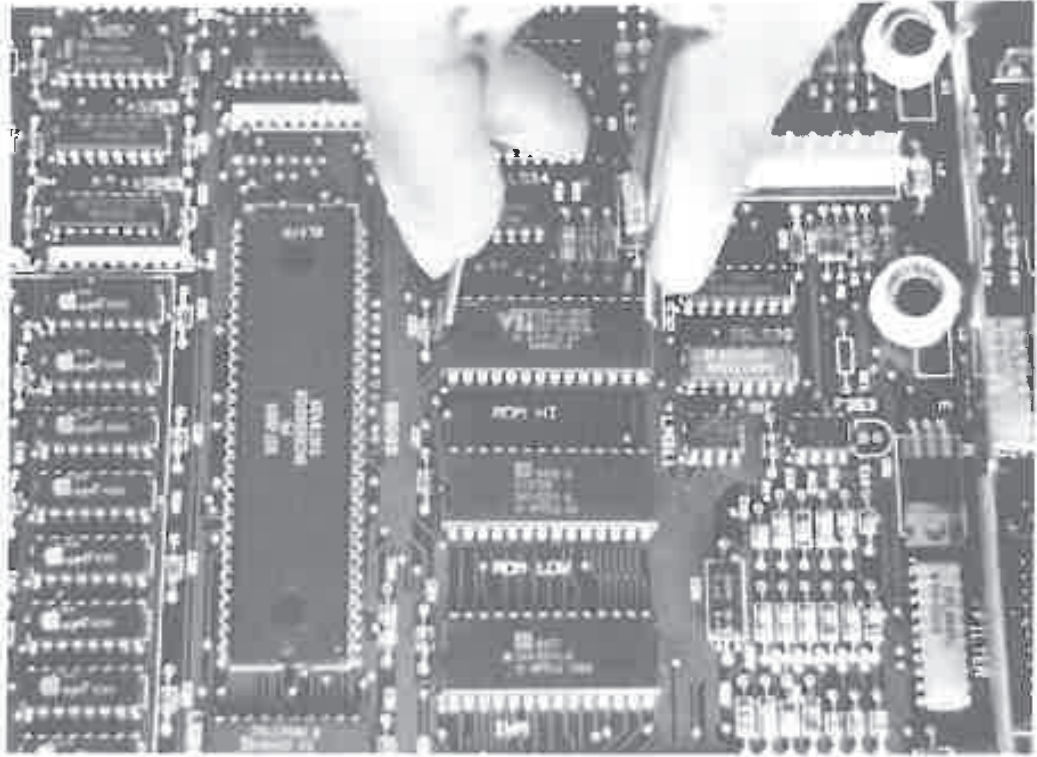

Figure 10-10 Remove the old ROMs with an IC-puller.

If you don't have an IC-puller, use an alternating lever technique. Take small bites; switch sides often. There's no reason to break the pins, bend the pins, and destroy the old ROMs. They have value. They can power coprocessor boards in other computers, and, eventually, you may want to use them that way.

Straighten bent pins as shown in Figure 10-12, then wrap the old ROMs in antistatic packing and store them in a safe place.

With the old ROMs safely tucked away, carefully plug the new chips into the sockets, making certain that the notch is pointing away from the I/O connectors. Remember that the low number goes in the HI ROM spot. The high number goes in the LOW ROM spot. Try not to confuse the ROMs. For reference, the individual part numbers are given in Table 10-4.

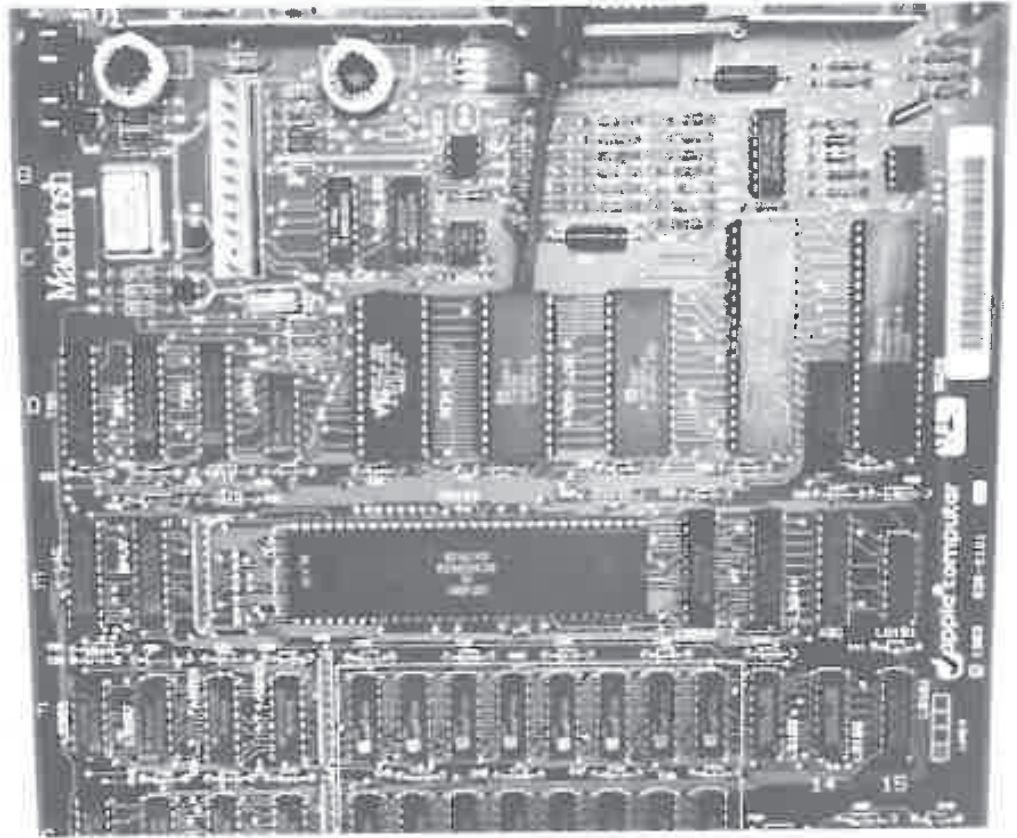

Figure 10-11 Free stuck ROMs with a screwdriver.

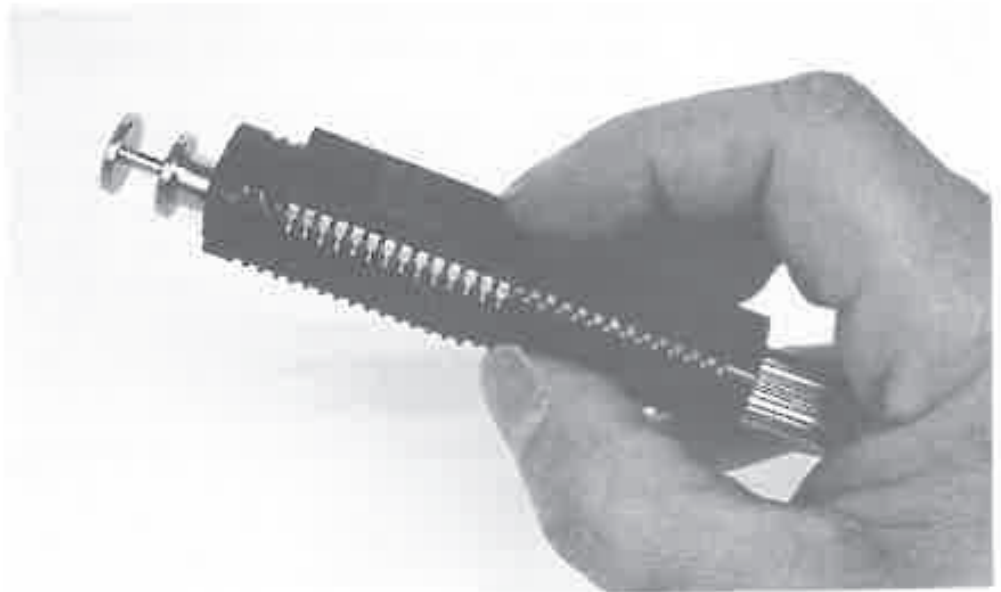

Figure 10-12 Straighten bent pins with a pin-straightener.

Table 10-4 ROM Part Numbers

Part#	Description
342-0220-x	HI ROM from 64K ROM set
342-0221-x	LOW ROM from 64K ROM set
342-0341-x	HI ROM from 128K ROM set
342-0342-x	LOW ROM from 128K ROM set

Identifying ROM Versions

The first version of the 128K ROMs has an annoying bug that precludes booting from a floppy disk until all connected SCSI devices are powered up. If you have a SCSI hard drive, or a SCSI scanner, or a LaserWriter IISC, or all three, you'll have to switch all of them on, even when all you (or the kids) want to do is play a game. The only alternative is to disconnect the first SCSI data cable, either at the back of the computer or at the back of the first device. The second and third versions of the ROMs correct that problem.

Here's how to tell which version of the 128K ROMs installed in your set:

ROM Version Test for 128Ke, 512Ke, and Macintosh Plus

1. Boot the Macintosh with a System disk.
2. While idling in the Finder, press the rear, interrupt button on the programmer's switch to enter the Mac's built-in debugger. Note that the so-called programmer's switch is somewhat of a misnomer—it's just a couple of buttons. The real switches (SW1 and SW2) are on the logic board, as indicated in Figures 10-2 and 10-3. If you can't find an official programmer's switch, try pushing SW1 with a strong wooden toothpick.
3. Assuming you do have 128K ROMs, pushing the interrupt button returns a dialog box displaying a greater than (>) prompt. With 64K ROMs, you get a System error dialog box. Type DM400000 at the > prompt and press the Return key. The result is a hexadecimal dump of the ROM code as shown in Figure 10-13. The ROM version is contained in the top row, second and third columns. 4D1E EExx indicates version 1 ROMs. 4D1E EAXX indicates version 2 ROMs. 4D1F 81xx refers to version 3. This information is summarized in Table 10-5.
4. Type G and press the Return key to exit the debugger. This instruction returns you to the Finder.

>								
400000	4D1E	EEE1	0040	002A	0075	6000	0056	6000
400010	075D	6000	0044	6000	0016	0001	76F8	4EFA
400020	28FC	0000	0000	0000	0000	6000	0016	1080
400030	40FA	0006	6000	0040	6600	00FC	538F	200F
400040	66EE	4CF9	0101	00F8	0000	0C80	55AA	AA55
400050	6610	43FA	000E	4E00	4CB9	0007	00F0	0000

Figure 10-13 Hexadecimal dump of the ROM code.

Table 10-5 ROM Version Numbers

Hex Number	Description
4D1E EExx	128K ROM set—version 1
4D1E EAXX	128K ROM set—version 2
4D1F 81xx	128K ROM set—version 3

Unofficial 800K Disk Drive/ROM Upgrades

Existing 400K disk drive brackets can be modified to accept OEM (Sony) 800K drives by drilling four new holes as shown in Figure 10-14. The horizontal axes of all four mounting holes are 3 centimeters from the top of the bracket. The vertical axes of the front mounting holes are 2.5 centimeters from the front of the bracket, and the vertical axes of the rear mounting holes are 8.5 centimeters further back or 11 centimeters from the front of the bracket. The original 400K mounting holes are not used.

Precision machinists excepted, it's best to drill oversize holes with a $\frac{13}{64}$ -inch bit. Here's the complete mounting procedure:

1. Using two of the original 3-0.5 × 4-mm screws removed from the 400K drive, add oversize washers, if necessary, and snug but don't tighten the left side of the 800K drive.
2. Rotate the drive bracket such that the right side is facing up. Using longer 3-0.5 × 8-mm screws and oversize washers, slide the $\frac{11}{64}$ OD × $\frac{1}{4}$ -inch sleeve bushing up onto the screw threads, and slip the assembly through the $\frac{13}{64}$ -inch hole. Snug the screws.
3. Remount the bracket using the original chassis screws.

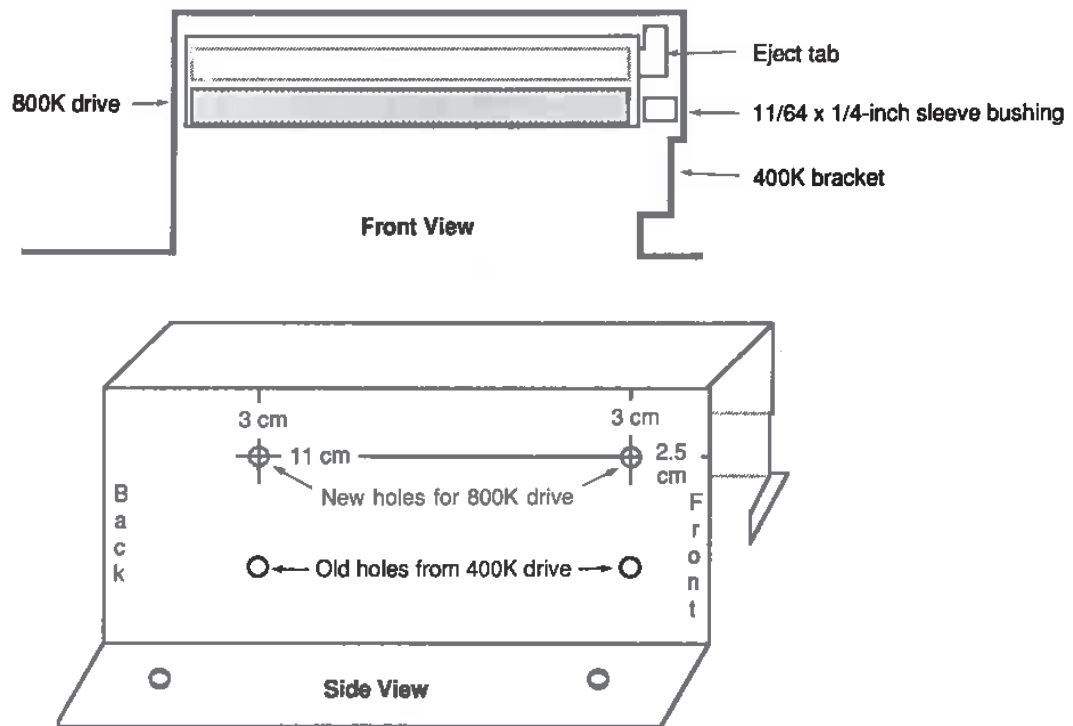

Figure 10-14 400K disk drive bracket modifications.

4. Partially insert a disk so that it looks like you just ejected it. Adjust the drive position such that the disk is both centered in the drive slot and perfectly squared to the opening. When you're satisfied, tighten the screws.
5. Push the disk all the way in, and use a straightened 1 ⁵/₈-inch (giant) paper clip to check the eject mechanism. If the disk ejects normally, you're all done. If the disk jams, don't try to force it out! That can do irreparable damage to the disk carrier mechanism. It also defeats the purpose! Instead, loosen the mounting screws and readjust the drive height until the disk pops out normally. Since you have to work from both sides of the drive, you may find it easier to remove the analog board when you do this.

Exceptions for Older Drives

Older models of the 800K drive won't boot unless 128K ROMs are installed. Newer models boot fine with any version of the ROMs. You can even install an 800K drive (part# 661-0345) in a 128K Mac and it'll work fine. You'll have twice as much MFS (Macintosh File System) disk storage as before, and if you add 128K ROMs, and boot with System version 3.2, you'll even be able to use HFS (Hierarchical File System) disks.

Although widely reported otherwise, the 128Ke (Enhanced) Mac also works fine. Upgrade to a 128Ke Mac by installing an 800K drive and 128K ROMs, choose the right third party memory upgrade (at the same time or later, there's no rush), and you'll never have to go through the 128K to 512K upgrade described earlier. This saves a lot of time and trouble.

Mixing 800K and 400K Drives

One thing that doesn't work very well on the MFS Mac (defined as an older 128K to 512K Mac with 64K ROMs) is mixing drives. When an 800K internal is used with a 400K external, you run into two problems.

Speed Control Problems First, OEM 400K (Sony) drives depend on a speed control signal from the operating system. 800K drives control their own speed. Strictly as an internal drive, the 800K model works fine. But as soon as you add an external 400K drive, the internal 800K drive motor begins to pulse. The fix is to add 128K ROMs.

Assuming that you're not interested in SCSI drives, it's possible to upgrade very inexpensively. Version 1 of the 128K ROMs works fine except for the SCSI bug, and by using an 800K drive pulled from a 2-drive Macintosh SE (which received an internal hard drive upgrade), you can often save 50% to 75% over the cost of a new disk-drive ROM upgrade.

One final tip for 64K ROM diehards. The motor speed signal comes in on pin-20 of the internal floppy drive data cable. Older internal 800K drives used a special data cable with no connection on pin-20. These ribbon cables are identified by a yellow stripe. Newer 800K drives disconnect pin-20 at the socket header. They use the standard red-striped ribbon cable. For reference, disk drive data cable pin assignments are given in Table 10-6. Disk drive socket header pinouts are shown in Figure 10-15.

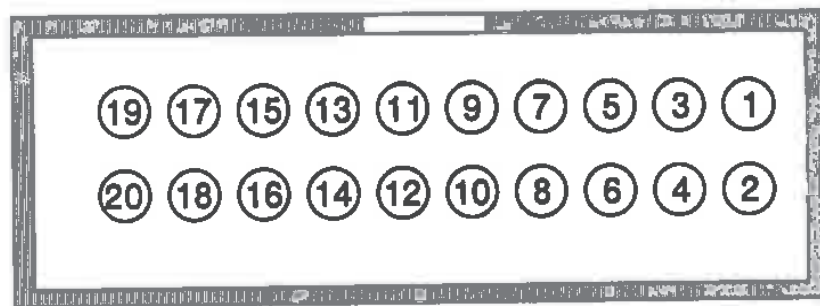

Figure 10-15 Disk drive socket header pinouts.

The numbering system used in OEM technical literature does not agree with the numbering system physically stamped on OEM socket headers! Figure 10-15 is consistent with the literature. For use with Table 10-6, disregard the numbers stamped on the headers. Proceed on the assumption that they're supposed to be numbered as shown in Figure 10-15.

Table 10-6 Disk Drive Data Cable Pin Assignments

Internal Disk Drive 20-pin Socket Header	Function	Ext DD DB-19M	External Disk Drive 20-pin Socket Header
1	Ground	1	1
2	Line CA0	11	2
3	Ground	2	3
4	Line CA1	12	4
5	Ground	3	5
6	Line CA2	13	6
7	Ground	4	7
8	Write strobe	14	8
9	-12.00 V	5	N/C
10	Write request	15	10
11	+5.00 V	6	11
12	Line SEL	16	12
13,15,17,19	+12.00 V	7	13
13,15,17,19	+12.00 V	8	15
14	Internal enable	N/A	N/A
16	Read data	18	16
18	Write data	19	18
20	Speed	10	20
N/C	External enable	17	14
N/C	Not connected	N/C	9,17,19
N/C	Not connected	9	N/C

Accidental Disk Initialization The second problem which occurs when 400K and 800K drives are mixed involves accidental disk initialization. Older versions of the Macintosh System File don't check for 800K disks in a 400K drive. Instead of an error message, you get a dialog box misinforming you that: "This is not a Macintosh disk. Do you want to initialize it?" Click the Initialize button, and you could possibly wipe out irreplaceable data.

System version 4.2 takes care of this, but it's too big to run on a 128Ke Mac, and it precludes using big programs (for example, certain word processors with integral spelling checkers) on a 512Ke Mac. The fix is to add more memory or use an external 800K drive as well.

Mac Disk Drive Upgrades for PC Compatible Computers

The problem with the last fix is that it leaves you with two perfectly good 400K Macintosh drives. These are perfect for upgrading PC compatible computers as shown in Figure 10-16.

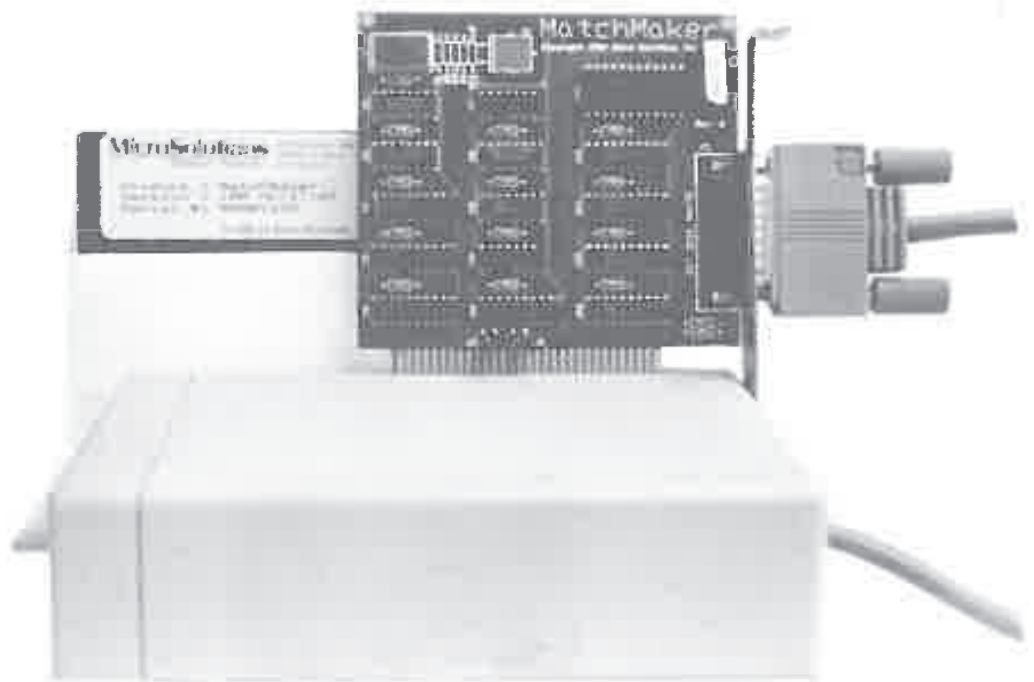

Figure 10-16 Macintosh disk drive upgrade for PC compatible computers.

This upgrade consists of a third party Macintosh disk drive controller card that fits PC expansion slots and a small DOS program called MAC.COM. The controller card works perfectly with *all* 400K and 800K Macintosh drives. Simply plug in the card, plug in a Mac drive, type MAC at the DOS prompt, and that's all there is to it.

MAC.COM is a terminate and stay resident program, similar to an INIT file on the Macintosh. If you add the line MAC.COM to your AUTOEXEC.BAT file, it'll load automatically and you won't have to type it each time you start the computer. MAC.COM even checks 400K drives for 800K disk events. Instead of misinforming you, 800K disks are immediately kicked out, and

you get an error message stating that: "An 800K diskette can't be used in a 400K drive." Of course, if you have an 800K drive connected, that doesn't happen. Everything about this upgrade works amazingly well.

A lot of people spend a small fortune trying to get 360K PC drives to work on the Macintosh. In most cases, you're better off putting a 400K Mac drive on a PC. Not only does this particular upgrade work fine, but it's also cost-effective because it makes use of the perfectly good drives you already own.

Unofficial SCSI Upgrades

Any 512K Enhanced Macintosh can easily be upgraded to 512Ke Plus status by adding an after-market Small Computer Systems Interface. As shown in Figure 10-17, typical kits consist of a small circuit board, an internal data cable, and an external SCSI connector. SCSI upgrades connect to the logic board in one of two ways. One type plugs into the ROM sockets. The other type clips onto the MC68000 processor.

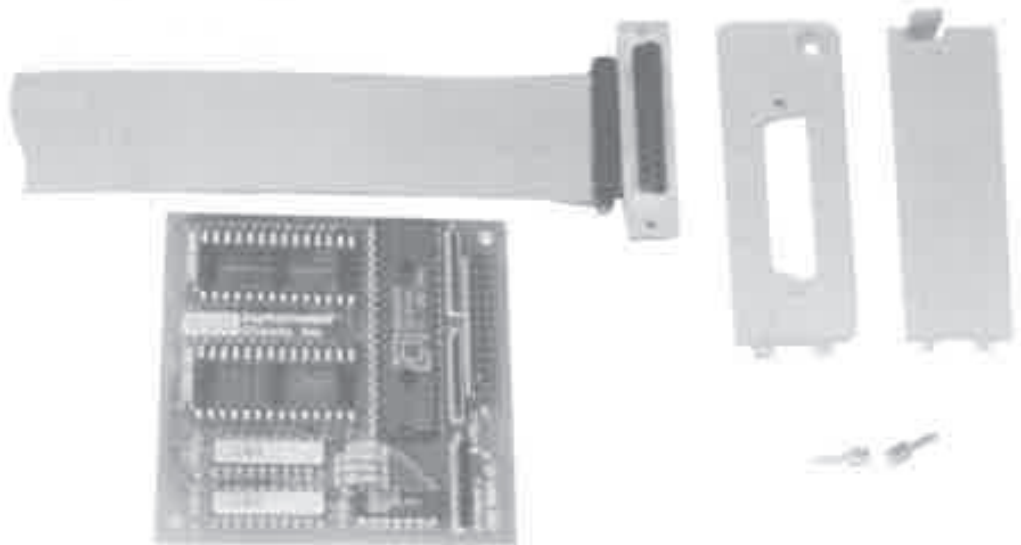

Figure 10-17 Typical SCSI upgrade kit consists of a small circuit board, an internal data cable, and an external SCSI connector.

Plug-in SCSI Upgrades

The preferred type of SCSI upgrade plugs into the ROM sockets. As shown in Figure 10-18, the ROM chips plug into sockets provided on the SCSI board. The SCSI data cable normally exits via the Macintosh battery compartment,

which is located just above the power switch on the back of the computer. An external DB25S SCSI connector mounted to a replacement battery compartment door completes the upgrade.

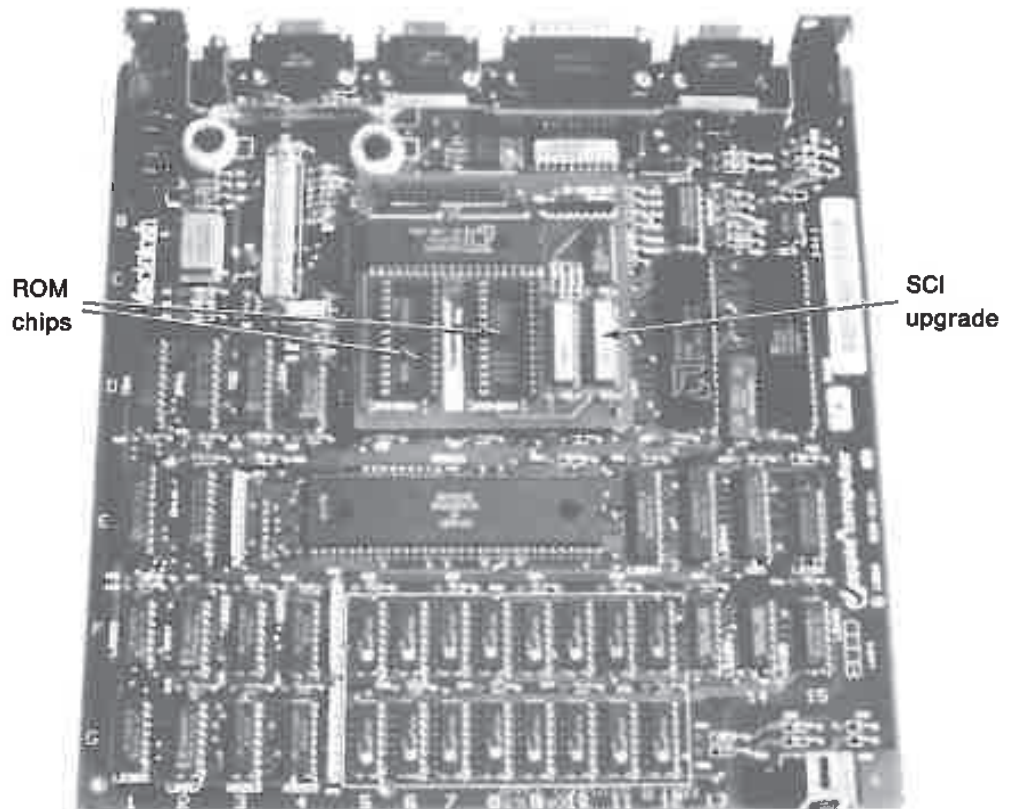

Figure 10-18 SCSI upgrade plugs into the ROM sockets. ROM chips plug into sockets provided on the SCSI board.

Clip-on SCSI Upgrades

A second type of SCSI upgrade does not plug into the ROM sockets. Instead, it mounts over the disk drive and clips onto the MC68000 processor with an extension cable. The SCSI data cable exits via the battery compartment, same as with the first type.

Clip-on upgrades can be fitted with two types of extension cables. One type works with (black) plastic MC68000 processors. The other type works with (purple-gray) ceramic MC68000 processors. You have to check the processor and specify the correct type; otherwise, you may end up with the wrong cable!

Both clip-on cables are prone to intermittent problems. If the clip is seated improperly, the contacts may short to the logic board. The symptoms

include a black and white striped screen, a checkerboard screen, a completely black screen, and various sad Mac icons. It all depends on which pin is shorted. The fix is to leave a little clearance between the clip and the logic board.

Another problem with clip-on upgrades involves prolonged use, high internal operating temperatures, polluted air, and high humidity. Under these conditions, a galvanic action takes place between the gold plating on the processor clip and the tin plating on the processor pins. The resulting corrosion forces the contacts apart, which eventually results in the total failure of the machine. The visible symptom is invariably a black and white striped display similar to the one shown in Figure 13-14.

One treatment involves cleaning all 128 contact points with liquid metal cleaner. The first 64 contact points are on the clip. The second 64 are on the processor itself. The problem with this fix is that it's time-consuming, and just like rust cleaned from the bumper of an automobile, the corrosion tends to come back.

Another fix involves soldering the processor clip directly to the MC68000 processor. This fix looks terrible, and it's a one-way street (unless you want to replace the processor), but at least it's permanent. Do it right, and you'll never be bothered by this problem again.

Choosing a SCSI Upgrade

With all that in mind then, here's what to look for when choosing a SCSI upgrade:

SCSI Upgrade Checklist

1. Something that plugs into the ROM sockets. See above.
2. 100% SCSI compatibility at the hardware level. Some SCSI upgrades only provide partial compatibility at software level. These may not work with the SCSI device you're interested in.
3. An external DB25S SCSI connector, exactly the same style used on the Macintosh Plus, the Macintosh SE, and the Macintosh II. Some upgrades come with external 50-pin Centronics connectors. Standard Macintosh SCSI cables don't fit 50-pin connectors!
4. Because of the C20 problem described below, either a board with elevated ROM pins and plastic standoffs for mounting stability, or a compact board that easily clears C20.

SCSI Upgrade Installation Problems

The only unexpected problem you're likely to have during a SCSI installation is with C20, an insidious 33-mfd 16-V axial aluminum electrolytic capacitor on the logic board. Some C20's are a lot thicker than others! Some plug-in SCSI

boards have razor sharp solder joints directly above this area. Seat the board, and you puncture the part. Everything stops working, even after you remove the upgrade. Troubleshooting can be very difficult. Usually, the puncture is practically invisible.

C20's location is illustrated in Figures 10-2 and 10-3. The usual fix is to replace $\frac{1}{4}$ -inch diameter (light-blue) C20's with *miniature* $\frac{3}{16}$ -inch diameter (black) parts. You can avoid failure entirely by replacing $\frac{1}{4}$ -inch diameter (light-blue) C20's right up front. Another failure avoidance strategy involves elevating the SCSI board with a set of 28-pin DIP sockets. Low profile $\frac{1}{8}$ -inch thick sockets provide just the right clearance. Sockets are a good fix for someone who'd rather not bother with soldering.

The color of the OEM part is a good indication of whether or not you're likely to have puncture trouble. Black-sleeved (miniature) C20's tend to work fine with SCSI upgrades. Blue-sleeved (standard) parts tend to puncture. If the SCSI board is small enough so that it clears C20, or if it clips to the MC68000 processor and mounts over the disk drive, you don't have to worry about C20 at all.

The hardest part of the whole process is trimming the battery compartment. To avoid pinching the data cable, a small plastic ridge has to be trimmed as shown in Figure 10-19. Older battery compartments tend to be brittle. If the razor knife slips, you could get a serious cut.

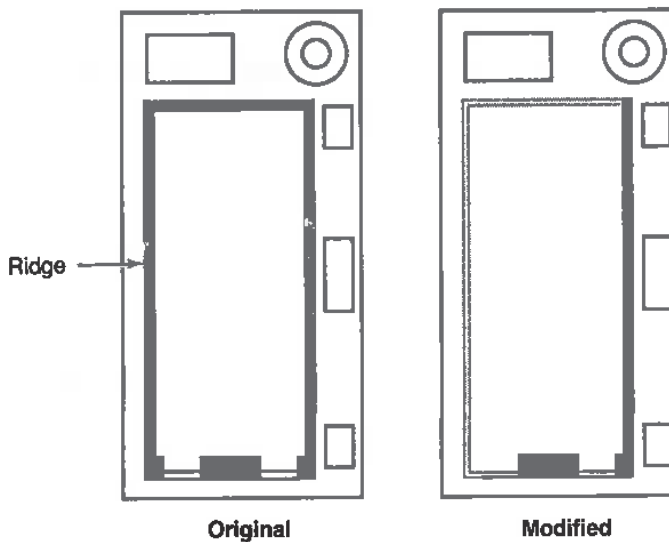

Figure 10-19 Battery compartment modification details.

If you can't boot the computer after installing the upgrade, and you haven't punctured C20, chances are you mixed up the ROMs or put them in upside down. Refer to Table 10-4 for part number confirmation. SCSI boards only work with 128K ROMs. The HI ROM has the lower number. The LOW

ROM has the higher number. The notches point away from the I/O connectors, same as all the other chips on the board.

With plug-in boards, it's also possible to offset the board in the ROM sockets. This error, along with the fix, is shown in Figure 10-20. If the misaligned pins become horribly bent as a result, use a pin-straightener to correct the problem as shown in Figure 10-12. Realign the board as shown in Figure 10-20, and everything will be OK.

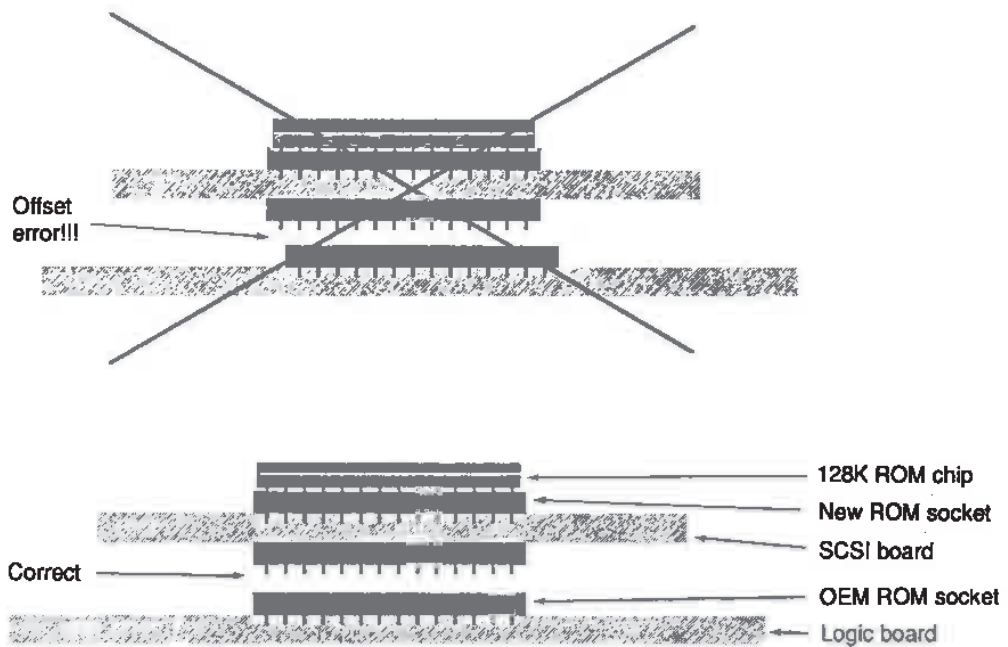

Figure 10-20 Plug-in SCSI board alignment details.

Finish up by adjusting the +5.00-V supply and the video circuitry as explained in Chapter 3. Assuming that you've never installed a SCSI upgrade before, figure on spending at least an hour to install either type. Subsequent jobs should only take 15 or 20 minutes.

Board Level 512Ke to Mac Plus Upgrades

The OEM 512Ke to Mac Plus upgrade involves a simple board swap. You pull out the old board as shown in Figure 10-1, remove the ROMs as shown in Figures 10-10 to 10-11, plug them into the new board, and slide it into place. Unofficially, you also have to adjust the +5.00-V supply and the video circuitry as explained in Chapter 3, and you should at least perform the minimum power supply upgrade detailed in Chapter 7. All that can take a couple of hours.

The OEM upgrade also includes a new rear case, needed to fit the expanded I/O strip on the new logic board. The old rear case is not used.

Cabling Requirements

The OEM upgrade also requires new modem and printer cables. 128K to 512K logic boards are fitted with DB9S connectors. The Mac Plus logic board is fitted with mini DIN 8S connectors. DB9P cables don't fit DIN 8S connectors!

Rather than buy new cables, you can modify, buy, or build adapters for your existing cables. Mini DIN 8P to DB9S adapter cable pin assignments are given in Table 10-7. Mini-DIN 8P connector pinouts are shown in Figure 10-21.

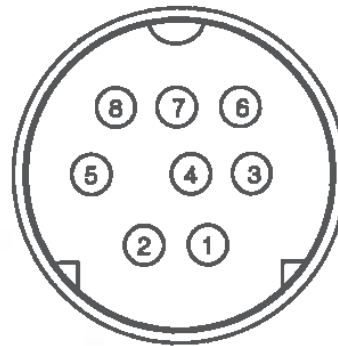

Rear View (solder side)

Figure 10-21 Pinouts for mini DIN 8P connectors.

Table 10-7 Adapter Cable Pin Assignments

Mini-DIN 8P	Function	DB9S
1	Output HShake	6
2	Input HShake	7
3	Transmit data-	5
4	Ground	1, 3
5	Receive data-	9
6	Transmit data+	4
7	Not connected	
8	Receive data+	8

Mac Plus SIMM Upgrades

Unlike the original 128K to 512K Macintosh logic boards which have soldered on-board memory, the Mac Plus logic board uses detachable plug-in memory modules (SIMMs.) As illustrated in Figure 10-22, the RAM chips are indirectly soldered to the modules instead of directly soldered to the logic board. Memory upgrades are performed by unplugging the stock modules and replacing them with higher capacity units. Instead of taking four hours, the actual installation takes barely 15 minutes.

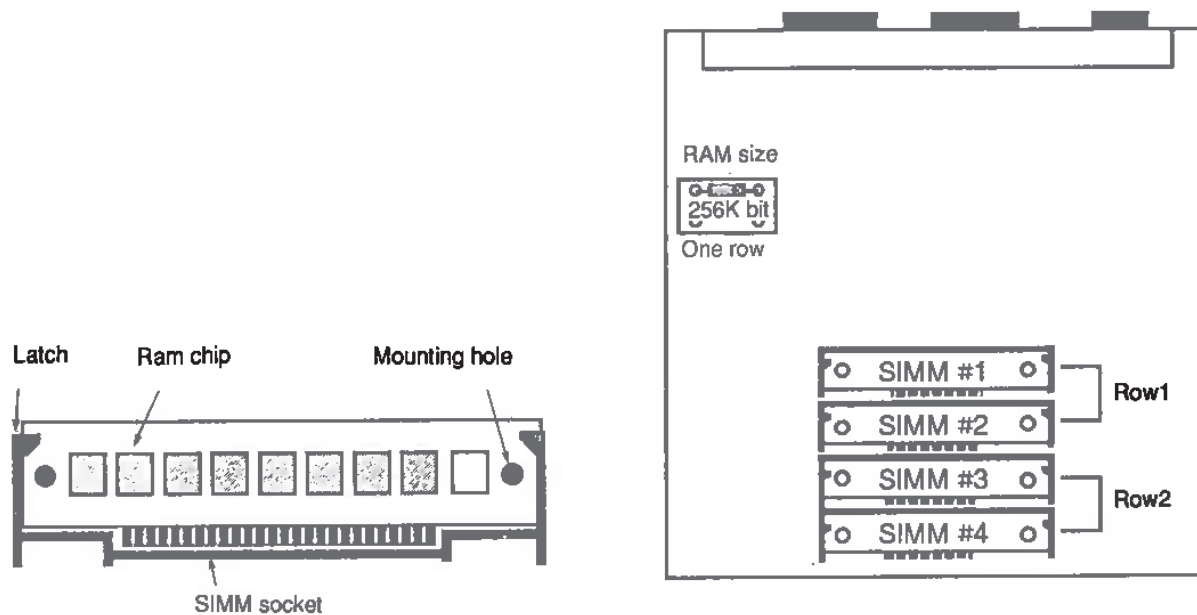

Figure 10-22 SIMM detail for the Macintosh Plus logic board.

Five memory configurations are possible: 512K, 1024K, 2048K, 2560K, and 4096K. In other words, you can go down to $\frac{1}{2}$ Mb, up to 2Mb, up to 2.5Mb, or all the way up to 4MB (megabytes).

SIMM Upgrade Concepts

As shown in Figure 10-22, SIMMs are arranged from back to front in reverse numerical order. The SIMM closest to the back of the computer is SIMM number 1. The SIMM closest to the front of the computer is SIMM number 4. The hierarchy starts from the middle of the board and works its way to the edge.

The next concept has to do with rows. Physically, there are four SIMMs arranged in one row. If you stand the board on edge, there are four rows of RAM chips arranged 8 to a SIMM. All that is irrelevant. Ignore physical rows.

Electrically, there are only two rows. The 16 chips on SIMMs 1 and 2 are electrically connected in one row. The 16 chips on SIMMs 3 and 4 are electrically connected in another row. Since it's electrical rows, not physical rows, that matter, OEM references to "one row" actually refer to SIMMs 1 and 2. OEM references to "two rows" refer to all four SIMMs. Just remember that it's the electrical layout, not the physical layout, that counts.

1Mb to 2Mb SIMM Upgrades

This upgrade involves removing all four of the stock 256K SIMMs, and installing megabit SIMMs in Row 1. The remaining pair of 256K SIMMs is not used. Row 2 is left empty.

In addition, R8, a 150- Ω 5% carbon film resistor located at grid reference C1, has to be removed, and R9, a missing 150- Ω 5% carbon film resistor also at grid reference C1, has to be installed. New 150- Ω resistors are color-coded brown green black, gold. In practice, you can desolder R8, clean the holes at R9, and reinstall the very same part. A new resistor is generally not needed. The approximate locations of R8 and R9 are shown in Figure 10-23.

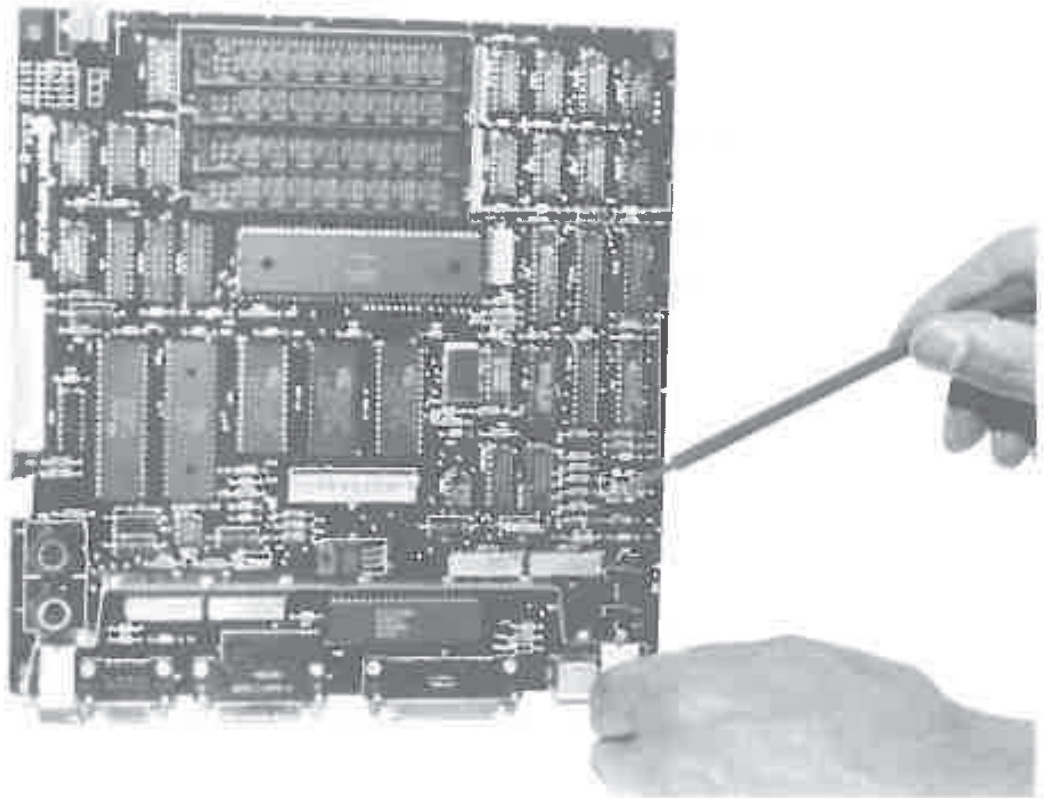

Figure 10-23 Location of Mac Plus memory size resistors.

Note that R8 is labeled {only} "256 KBIT." As indicated by the addition of the word {only}, that label is intended to be a true or false statement. If it's not true that all of the installed SIMMs are 256K SIMMs, R8 has to come out. In this case, R8 has to come out, because one row contains 1024K (megabit) SIMMs.

The {only} "ONE ROW" label beside R9 is also intended to be a true or false statement. Previously, only ONE ROW was false, because *both* rows contained SIMMs. In this case, R9 has to go in, because the *second* row is left empty.

Finish up by adjusting the +5.00-V supply and the video circuitry as explained in Chapter 3.

1Mb or 2Mb to 2.5Mb SIMM Upgrades

This upgrade involves removing all of the existing SIMMs, installing a pair of megabit SIMMs in Row 1, and reinstalling a pair of 256K SIMMs in Row 2. Any leftover SIMMs are not reused.

Both R8 and R9 (assuming either is present) have to be removed. As explained previously, R8, labeled "256 KBIT," is *only* used if it's true that both rows contain 256K SIMMs. That's not true in this case, so R8 has to come out. R9, labeled "ONE ROW," also has to come out because *two* rows of SIMMs are installed.

Finish up by adjusting the +5.00-V supply and the video circuitry as explained in Chapter 3.

1Mb, 2Mb, or 2.5Mb to 4Mb SIMM Upgrades

This upgrade involves removing all of the existing SIMMs and replacing them with two or four megabit SIMMs, as necessary. Any previously installed 256K SIMMs are not reused.

Both R8 and R9 (assuming either is present) have to be removed. As explained above, R8, labeled "256 KBIT," is only used if it's true that both rows contain 256K SIMMs. That's not true in this case, because both rows contain megabit SIMMs. R9, labeled "ONE ROW," also has to come out because two rows of SIMMs are installed.

Finish up by adjusting the +5.00-V supply and the video circuitry as explained in Chapter 3.

Troubleshooting SIMM Upgrades

If you get a sad Mac icon as shown in Figure 10-7 on power-up, or if you get a black and white striped screen as shown in Figure 13-14, or a checkerboard screen, instead of the usual blinking floppy disk icon, it usually means one or more of the SIMMs is loose.

Check the mounting holes on each SIMM to make sure it's properly seated. The black plastic knobs protruding from the SIMM sockets should be

sticking all the way through the mounting holes. The black plastic latches extending from the SIMM sockets should be on top of (not alongside or underneath) the SIMM.

Sometimes, the cause of a loose SIMM is a cracked SIMM socket. Cracked sockets should always be replaced on principle. Even if you manage to get the set going again, you won't be able to rely on it unless all of the SIMMs are fully seated and properly secured.

If you suspect a bad SIMM, try substitution, or reinstall the memory size resistors as needed, and test the existing SIMMs in pairs, using Row 1. To check out a stock Mac Plus, install R8 (only 256 KBIT) and R9 (only ONE ROW) and pull the SIMMs from Row 2. This configuration results in a Mac Plus with 512K of memory. Assuming it powers up, use a process of elimination to isolate the bad module.

Macintosh SIMMs vs PC SIMMs

PC SIMMs are the same physical length as Macintosh SIMMs but they contain nine RAM chips instead of eight. These work fine in PC's *and* Macs. Eight-chip Mac SIMMs *only* work in Macs. If you have access to nine-chip SIMMs, or if you might need to use them in a PC someday, don't hesitate to try them. Assuming they're first quality nine-chip SIMMs, they'll give equally good service, in either machine.

Unofficial 512Ke to 4Mb Upgrades

An alternative to the OEM Mac plus upgrade is to fit 128Ke and 512Ke logic boards with an after-market memory upgrade. There are three basic types:

1. Clip-on upgrades.
2. Snap-on upgrades.
3. Solder-on upgrades.

All three work fine with old modem and printer cables, because they supplement rather than replace your existing equipment.

Clip-on Memory Upgrades

Clip-on memory upgrades suffer from the same reliability problems as clip-on SCSI boards. The attraction of this type is that they're usually equipped with faster on-board MC68000 processors. Consequently, they can be used to upgrade any 128Ke or 512Ke logic board all the way to 4Mb. In the case of 128Ke boards, it's generally not necessary to upgrade to 512K, first. Most of these boards use SIMMs, the same as newer Macs. Also, the final results can be substantially faster than a stock Macintosh Plus. Some models even provide sockets for MC68881 math coprocessors. Some come with integral

high-speed SCSI ports. The best models can knock the socks off a stock Macintosh SE.

Snap-on Memory Upgrades

Snap-on upgrades for the 512Ke are generally very reliable, but they only work with (black) plastic standard-size RAM chips. Gray-purple ceramic RAM chips are too wide for the standard snap connectors. Some sources recommend enlarging the snap connectors with a razor knife. That's crazy in my book. If you enlarge them too much they might not fit very well. Plus, you'll never be able to transfer the upgrade to another logic board. You may want to do that someday.

The best solution (if necessary) is to replace the two (gray-purple) ceramic RAM chips under the snaps with standard-size (black) plastic RAM chips. The only two chips you have to bother with are at locations F5 and G5. Don't use sockets! The upgrade also contacts other (black) plastic chips on the board. If you elevate two chips, it'll no longer make contact with the others.

Snap-on memory upgrades don't usually provide MC68881 coprocessor sockets, or come with integral SCSI ports, but they're sometimes bundled with plug-in SCSI upgrades. This combination of upgrades is very popular. It's inexpensive, it's known to work well, and it's easily reversible.

Solder-on Memory Upgrades

Solder-on memory upgrades for the 512Ke are the hardest of all to install, but assuming a capable installer, they offer the highest degree of reliability. Better boards are layered, to reduce noise, and socketed so that extra RAM can be added, and/or removed at the chip level, as necessary.

Good designs either incorporate SCSI upgrades or allow easy access to the ROM sockets, so you can add the plug-in type of SCSI board later. The best designs also provide OEM replacement parts together with detailed instructions for restoring the logic board to original condition.

Other Memory Upgrade Considerations

Every one of the above upgrades loads the power supply and shrinks the display. Every one of them makes the Macintosh run hotter than ever. Even if the instruction manuals don't advise doing so, finish up by readjusting the +5.00-V power supply, and the video circuitry as explained in Chapter 3.

The power supply should also be brought up to at least minimum Mac Plus standards as explained in Chapter 7. 4Mb memory kits warrant a heavy power supply upgrade.

If the memory upgrade kit came with a fan, install it. If the memory upgrade kit didn't come with a fan, add one. Don't believe the pundits who keep saying it's not necessary. That only applies if you live in Alaska.

CHAPTER

11

Keyboard Repairs

This chapter covers 128K to Macintosh Plus keyboard repairs. Three models are covered:

1. Part# MO110—the stock Macintosh 128K to 512Ke keyboard
2. Part# MO120—the optional numeric keypad for Part# MO110
3. Part# MO110A—the stock Macintosh Plus keyboard with integral keypad

Both styles are completely interchangeable. You can use a 128K keyboard (with or without the optional keypad) on a Macintosh Plus and, although widely believed otherwise, you *can* use a Macintosh Plus keyboard on the 128K, 512K, and 512Ke. Everything, including the integral keypad, works fine. So, in a pinch, you can substitute one keyboard for the other.

All three products use Alps brand long-stem key switches. Due to dust and hard use, these switches sometimes become intermittent or break altogether. This chapter shows how to repair intermittent switches, how to replace bad switches, how to fix completely dead keyboards, and shows how to make a longer keyboard cable.

Standard Safety Precautions

To prevent almost certain damage to the logic board, and to minimize the possibility of electric shock, always switch off the computer and physically disconnect the keyboard cable from the keyboard before beginning repairs.

Switching off the power *before* disconnecting the keyboard cable (or any peripheral cable, for that matter) is very important. Although 128K to Macintosh Plus computers seem to tolerate live disconnects, the Macintosh SE and the Macintosh II generally do not. On most computers, unplugging anything without turning off the power causes damage. Develop good safety habits now, and you'll never have to worry about costly live disconnects later on.

Disassembly Procedure

Alps brand long-stem key switches are somewhat delicate, so always begin the disassembly procedure by spreading out a soft towel. Flip the keyboard upside down and loosen the screws in the bottom cover with a #1 Phillips-head screwdriver as shown in Figure 11-1. The 128K to 512Ke keyboard has five screws. The Mac Plus keyboard has six screws.



Figure 11-1 Loosen the screws in the bottom cover with a #1 Phillips-head screwdriver.

Once the screws are loose, lift the bottom cover straight up. You shouldn't need a case popper. If the bottom cover doesn't come up, it means one (or more) of the screws needs further loosening. To find out which screws, flip the keyboard right side up. The loose screws will fall out. Put these aside, flip the keyboard upside down again, and remove any screws that remain.

Once the bottom cover is up, lift the keyboard assembly away from the top cover. Put the five or six screws, the top cover, and the bottom cover aside. There are more screws on the circuit board, but these need not be removed.

Intermittent Key Switches

If you've had the keyboard for very long, especially if you've kept it uncovered, you might be surprised by an intricate layer of dust. This layer, fascinating as it may be, should be removed with compressed air. If no air compressor is available, blow the dust out with the exhaust end of a vacuum cleaner. Don't try to vacuum the dust. The key stems are delicate. You could easily damage them with stiff vacuum cleaner tools.

Once the dust is out, remove the key cap from the affected switch by pulling it straight up as shown in Figure 11-2. If the key switch is in the middle of the keyboard, start at the top row and work your way down. You may have to remove one or two nearby caps to get at the one you want.



Figure 11-2 Remove the key cap by pulling straight up.

If you see evidence of a liquid spill, spray the affected area with WD-40 lubricant to loosen the residue. Let it set for a while, then mop up the mess with cotton swabs as best as you can. Now, spray WD-40 directly into the intermittent key as shown in Figure 11-3. Work it in by pressing the key stem up and down. In most cases, a couple of squirts is all it takes. WD-40 drives out moisture, lubricates, and generally dissolves corrosion. To test your work, replace the keyboard covers, attach the keyboard cable, and switch on the computer. If the key switch works now, shut down, replace the key cap, reattach the cover screws and you're all done. If the key switch is still

intermittent, the mechanism is probably broken and will have to be replaced; proceed to the next section.



Figure 11-3 Intermittents can be treated with WD-40.

When reattaching the cover screws, bear in mind that the covers are made of breakable plastic. To avoid snapping the plastic, always hold the screwdriver between your thumb and index finger. Bear down just enough to snug the screws.

Broken Key Switches

WD-40 will almost always fix intermittent contacts but it can't mend broken plastic. For that you'll need a replacement Alps brand long-stem key switch.

The difference between an Alps brand long-stem key switch and an Alps brand short-stem key switch is shown in Figure 11-4. Long-stem key switches have a long plunger and a short key cap. Short-stem key switches have a short plunger and a long key cap. Both types work in a Macintosh, but if you use a short-stem key switch, you have to replace the cap as well. Otherwise, the new key will sit much lower. The problem with swapping key caps is that short-stem key caps tend to be gray or brown. Original Mac key caps are beige. In that case, you can easily replace all of the keys in a single row for aesthetic purposes. Surprisingly, that's also cost-effective. Readily available "surplus" keyboards (loaded with 64 brand new short-stem key switches) generally cost less than a single "used" OEM long-stem switch. Sometimes, the shipping charges cost more than the surplus keyboard!

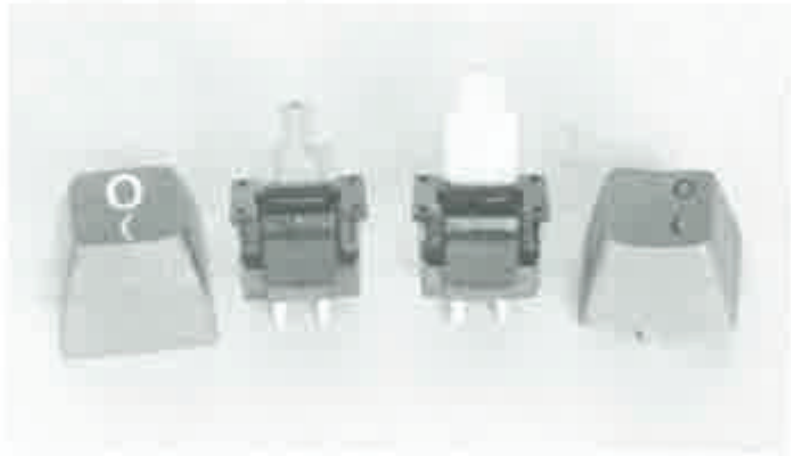

Figure 11-4 Long-stem key switches have a long plunger and a short key cap. Short-stem key switches have a short plunger and a long key cap!

In either case (short-stem switch or long-stem switch) the replacement procedure is the same. Begin by desoldering the defective switch as shown in Figures 11-5 to 11-7. Use a 15-W, grounded soldering pencil and a vacuum desoldering tool. Be sure to discharge the waste solder into a can each time you recharge the tool, otherwise the waste will just spit onto the circuit board. Next, check the desoldered switch tails with a screwdriver or a soldering aid. They should break away from the circuit board easily and/or move freely. If they offer much resistance, reheat the joint and vacuum it clean (with the desoldering tool) until you can wiggle the switch tails. If you experience any trouble, check your technique against Figure 11-8.

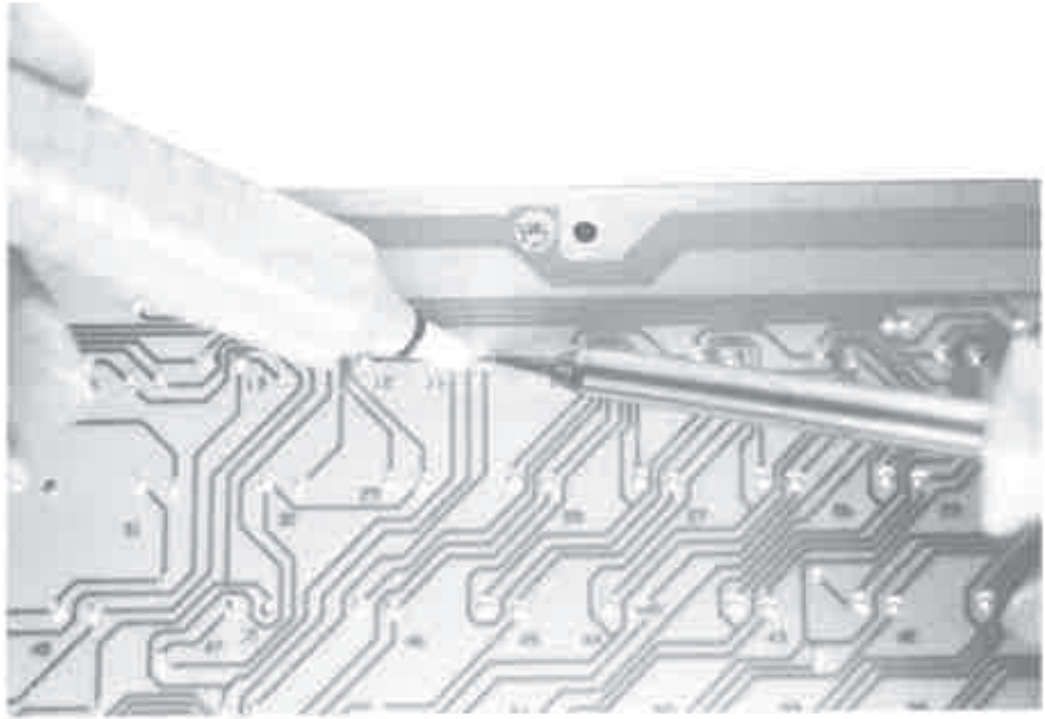

Figure 11-5 Desolder the defective switch with a 15-W, grounded soldering pencil and a vacuum desoldering tool.



Figure 11-6 Discharge the waste solder into a can each time you recharge the tool. Otherwise, it just spits onto the keyboard.

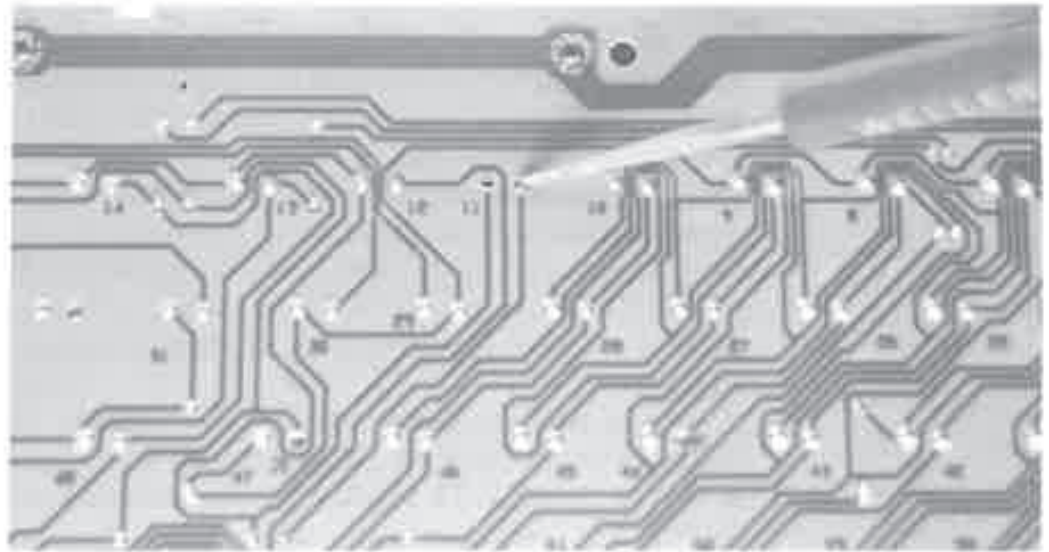

Figure 11-7 The desoldered switch tails should move freely when poked with a soldering aid.

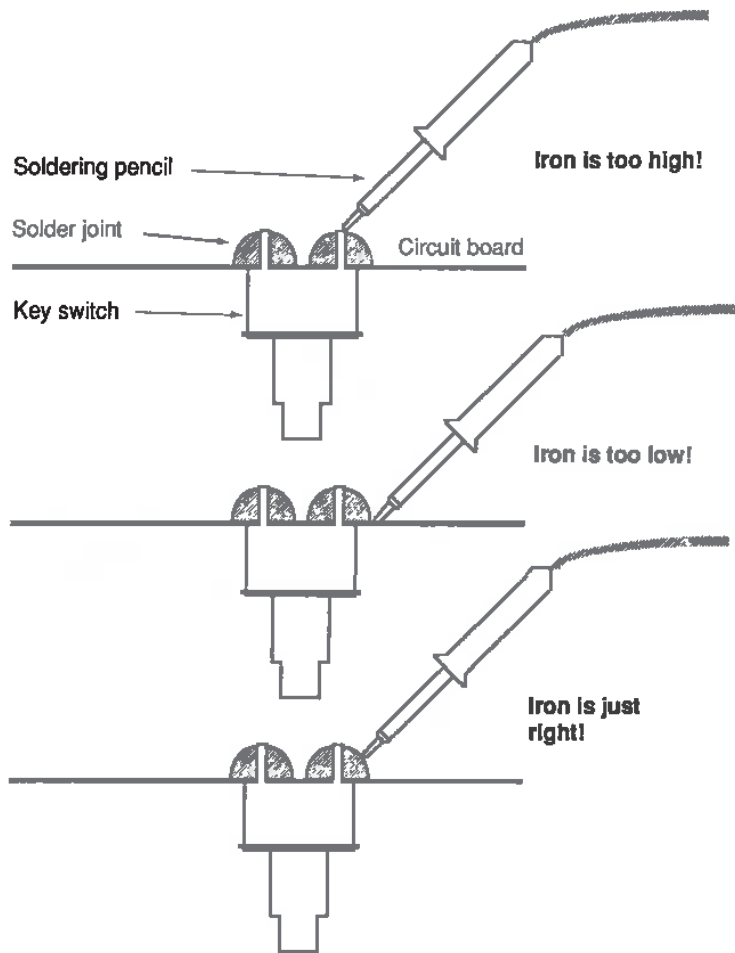

Figure 11-8 The top iron is too high—the switch is going to melt. The middle iron is too low—the circuit board is going to melt! The bottom iron is just right—it's centered on the joint, just the solder will melt.

When you can wiggle both switch tails, turn the keyboard right side up and press in the key switch locking tabs as shown in Figures 11-9 and 11-10. While pulling up on the key stem, try to release one side and then the other. Use a rocking motion, and pull straight up. Since these are *spring* tabs, they're going to resist compression and fight you all the way. If you have an assistant, try to work both tabs simultaneously (from underneath, if possible) while the other person pulls on the stem. Study the drawing in Figure 11-11. Removing your first key may prove to be a five-minute challenge. Once you see how it's done, subsequent keys pop out in seconds. An empty key cavity is shown in Figure 11-12.

Note that the solder tail holes are slightly off-center. Line up the replacement key switch so that the holes match, and snap it into place as shown in Figure 11-13. Replace the cap as shown in Figure 11-14, turn the keyboard upside down again, solder the tails to the circuit board and that's it. To test your work, replace the keyboard covers, attach the keyboard cable and switch on the computer. If the key switch works now, shut down, reattach the cover screws (remember not to tighten very hard) and you're all done.



Figure 11-9 Depress one of the locking tabs with a soldering aid or a small screwdriver.



Figure 11-10 While pulling up on the key stem, try to release one side, then the other.

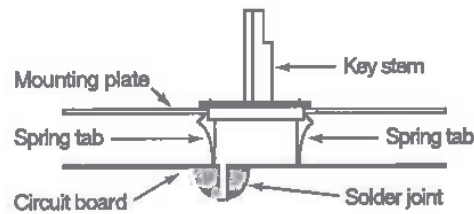

Figure 11-11 Spring tabs lock the switch to the mounting plate. Solder joints lock the switch to the circuit board. To remove a switch, first desolder the joints, then push in the tabs and pull the key stem upward.



Figure 11-12 An empty key cavity.

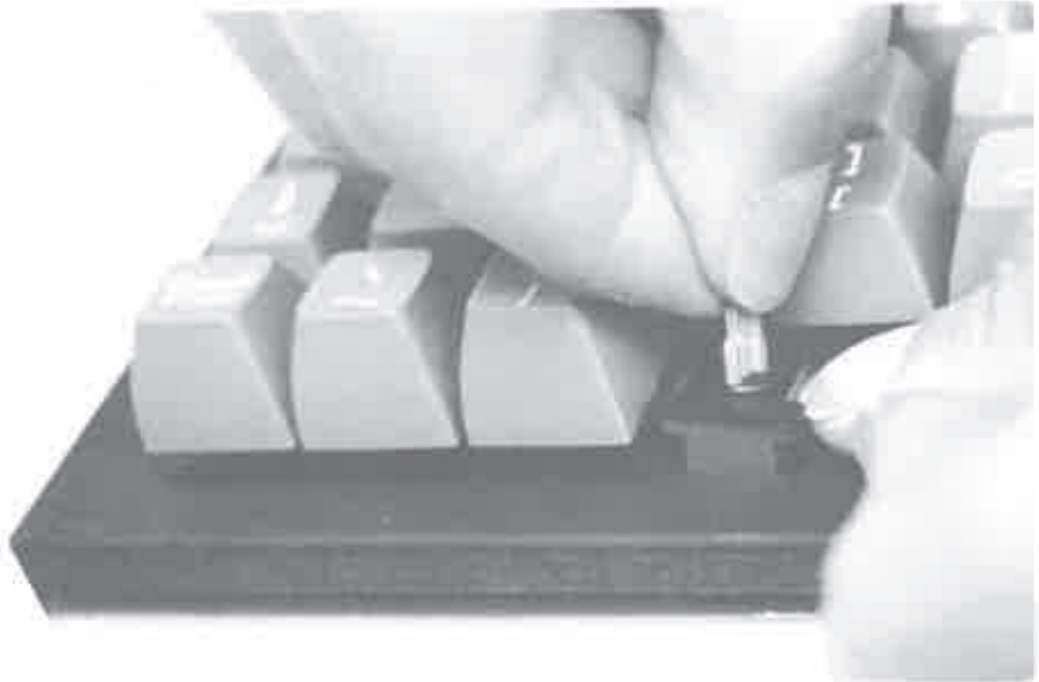

Figure 11-13 The new switch snaps into place.



Figure 11-14 Replace the cap, resolder the tails and you're all done!

Emergency Repairs

With the exception of the Caps Lock switch, all of the key switches on either keyboard are identical. So, even without spare parts, if a critical key fails, you can replace it with a less important key. 128K to 512Ke keyboards actually have two Option keys. Most people use only one. Exchange the broken key for the spare Option key (it's on the right side, next to the Enter key) and you can keep right on going with no loss of functionality. Mac Plus keyboards only have one Option key, but you can think of the keypad as a full set of spares. Swap the critical key with a spare numerical key, and once again you'll be back in business with no loss of functionality.

Dead Keyboards

A dead keyboard is defined as one where absolutely nothing works. The number one suspect is an incorrectly wired keyboard cable. Macintosh keyboard cables resemble telephone handset cables, but they're not the same. Innocently substituting one for the other results in major damage, not just to the keyboard, but also to the Macintosh itself. **For that reason, never test a dead keyboard without checking the attached cable first!** The correct wiring for a keyboard cable is shown in Figure 11-15.

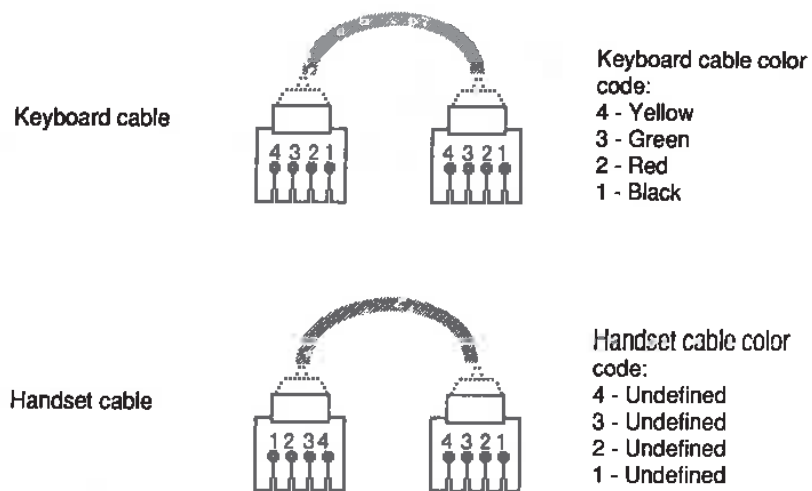

Figure 11-15 Connectors on a keyboard cable are wired exactly the same. Connectors on a telephone cable are mirror images of each other.

Since modular connectors are clear plastic you should be able to determine whether or not the wiring is correct by making a visual inspection. Line up the connectors and compare them to the diagram. If the cable is wired for telephone use, and assuming someone actually plugged it in and switched

on the computer, then chances are the logic IC is blown. Put aside the bad cable and tag it: "Telephone cable, not for Macintosh use!" To replace the logic IC on model MO110A (Mac Plus) keyboards, remove the spacebar as shown in Figure 11-16. Underneath, you should find an 8550 or an 8728 chip. MO110 (128K to 512Ke) keyboards may have either an 8021H or an 8415 chip, located near the Caps Lock key. Both keyboards are socketed which makes chip replacement simple. The 8550 chip is too long for most IC pullers but you can get it out by loosening one end then the other with a small flat-head screwdriver. Use an alternating lever technique as shown in Figure 11-17.

Remember that IC's have a notch which indicates correct orientation. When replacing the chip, always line up the notch on the IC with the notch on the socket. Never go by the writing. Look at Figure 11-16. Sometimes the writing is upside-down!

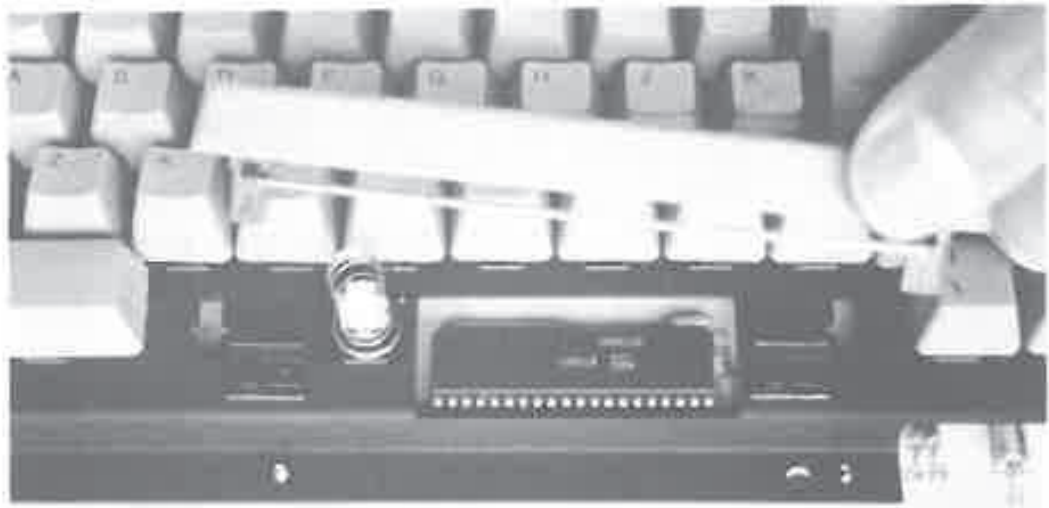

Figure 11-16 On MO110A (Mac Plus) keyboards, the logic IC is under the spacebar.

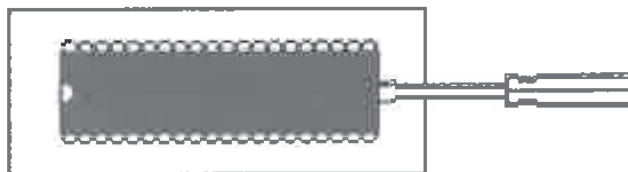

Figure 11-17 Pry the blown 8550 chip upward with a small flat-head screwdriver. Take small bites; switch sides often.

With a new chip and a new (or a rewired) cable, the repaired keyboard should work fine. Unfortunately, there may still be problems with the computer. When you repair the cable and replace the chip and the keyboard still doesn't work, try to test the repair on a known good Macintosh. If it works there, you've definitely got a second problem. Turn to the chapter on logic board repairs for further instructions.

Static Electricity

Logic chips are sensitive to static electricity, which is generally associated only with cold, dry weather. If you've got a seasonal static problem, just touching a replacement chip might destroy it. To minimize that possibility, surround yourself with natural materials. Wear cotton clothing. Avoid acrylics. Use a wooden chair. Keep away from vinyl. Try not to work on synthetic carpeting. Cement, tile, or wooden floors are preferable. Natural materials absorb moisture, and moisture prevents static build-up.

For maximum protection, wear an antistatic wrist strap. These have to be connected to a known good ground to be effective. Generally, that means you have to clip them to the center screw of an electrical outlet. A lot of people tend to overdo it. I'll put on a wrist strap in the winter, but I never bother come summer. The service manager of one of the largest OEM's in Silicon Valley told me there's not a single wrist strap in the place. If it's hot and muggy, don't worry about it, but if the cat can't get anywhere near you without getting her nose shocked, it would be foolish not to take precautions.

Custom Keyboard Cables

Part of the reason dead keyboards are so common is that the stock Macintosh keyboard cable is a little on the short side. Some people like to put the keyboard on their lap and lean way back. The stock cable won't stretch that far. The generally longer handset cable (which is right there on the telephone) appears to be identical, so why not try it? Pow! Although powering up with a handset cable causes major damage, it is possible to rewire one for Macintosh use by cutting off one end and crimping on a new modular connector. Even if you do it right (according to the wiring instructions in Figure 11-15), it's best to attach some sort of warning sticker to the keyboard. Otherwise, it may give someone the impression that handset cables are OK to use, as is. Even worse, you may forget that you modified the cable and reach for a stock telephone cable sometime in the future. Pow again! For that reason, a lot of knowledgeable people advise against modifying handset cables. I'll leave it up to you. A typical modular crimping tool is shown in Figure 11-18.

Note that modular handset (4-position/4-contact) connectors are smaller than modular wall plug (6-position/4-contact) connectors. Some tools can handle both sizes. Some can handle only one size. Be sure to buy the correct

tool for the job or it's not going to work! A warning sticker that you can print on a 1-inch by 3-inch mailing label is shown in Figure 11-19.

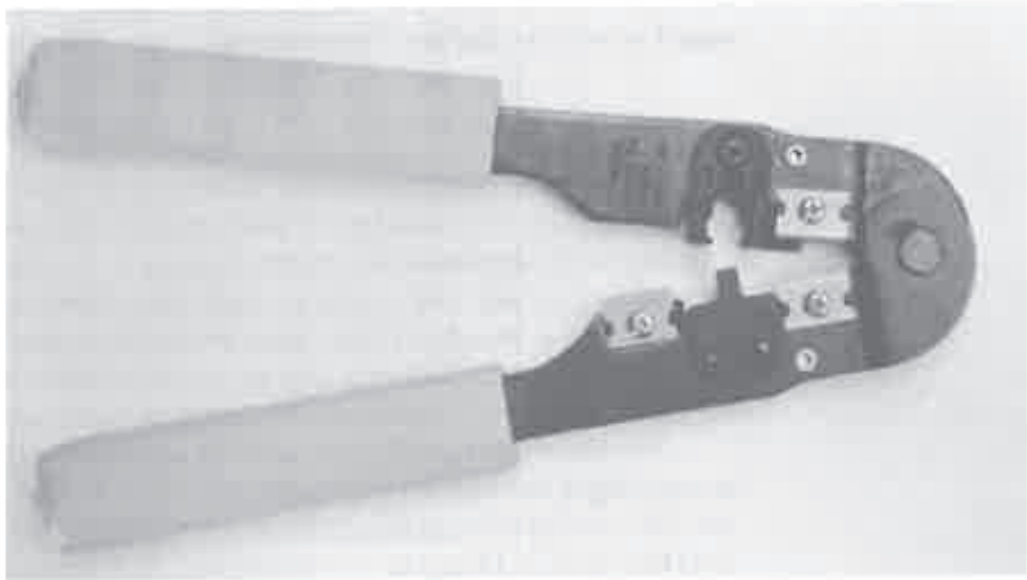

Figure 11-18 A typical modular crimping tool.

WARNING! This keyboard is not compatible with telephone handset cables!

Figure 11-19 Keyboard warning sticker.

The crimping tools are actually quite easy to use. A built-in straight razor cuts off the original plug. A second straight razor measures and strips the wire. There's no guesswork. A third area on the tool makes the connection. As shown in Figure 11-20, all you have to do is insert the wire and squeeze.

To make sure that you've oriented the new plug correctly, and to make sure that there are no bad connections, it's important to check continuity. Set your multimeter to read low ohms, $R \times 100$ or lower. If you have an audible continuity tester, use the audible setting. Slip a set of insulated alligator clips over the probe tips and fit the clips with dressmaker's (common) pins. If your meter has a needle pointer and a scale, touch the pins together and zero the meter. Mount the ends of the keyboard cable in a small vise, or have an assistant hold them. Now, touch the pins to each pair of connectors as shown in Figure 11-21.



Figure 11-20 Crimping a new connector.

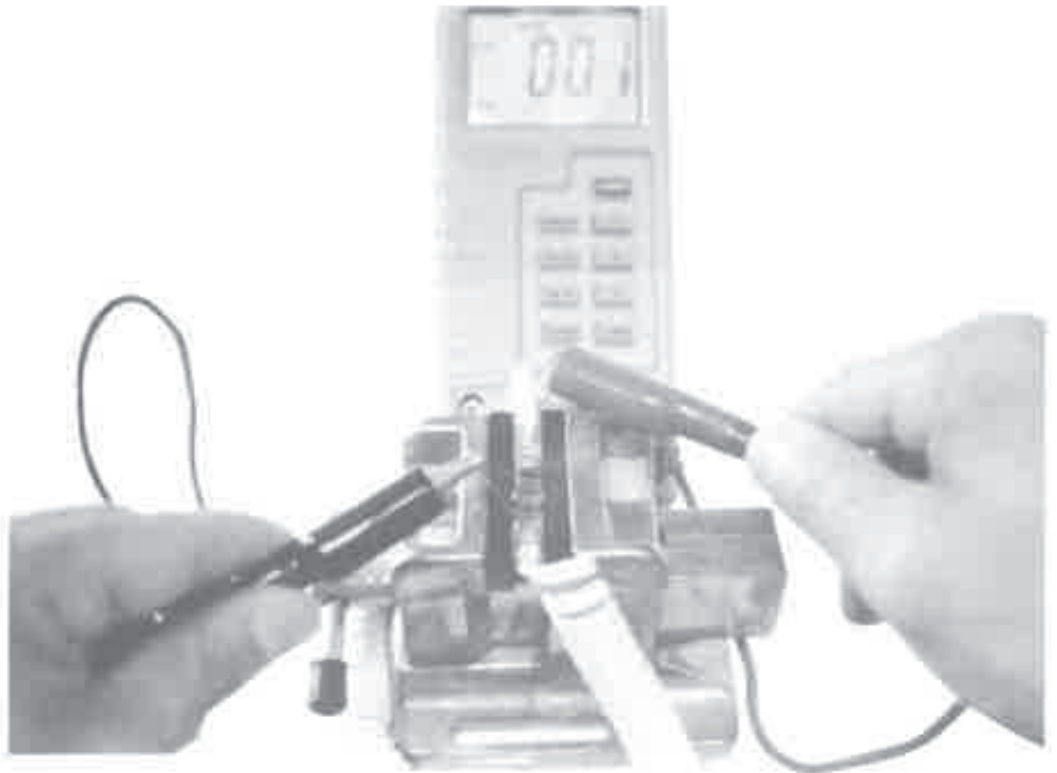

Figure 11-21 Checking the cable for continuity.

If the connection is good, the audible tester should beep and/or the meter should read 1 to 2 Ω . Anything higher than 2 Ω indicates a bad connection. In that case, try recrimping the connector. If the cable doesn't test any better, cut off the connector, and start over. Usually new crimps are very reliable. The real danger is that the entire procedure (cut, strip, crimp) is so simple, you might inadvertently crimp the new connector upside down. Instead of making a keyboard cable, all you will have made is another handset cable! If you *don't* test the cable and the upside-down connector is undiscovered, you'll do major damage the first time you plug it in. Be careful to orient the wire properly, as shown in Figure 11-15. Test your work afterwards to be sure you got it right.

Summary

OEM 128K to Macintosh Plus keyboards use Alps brand long-stem key switches. Due to dust and hard use, these switches sometimes become intermittent or break altogether. Long-stem key switches are hard to find, but readily available surplus keyboards often have compatible short-stem key switches. To use these on a Macintosh keyboard, you have to swap the key cap as well.

Telephone handset cables are not the same as keyboard cables. Their use results in blown keyboard logic. Keyboard chips are socketed for easy replacement, but often components inside the Macintosh are also damaged. That makes it tough to check your work.

Handset cables can be rewired for keyboard use with a modular crimping tool. Rewired handset cables work fine, but a warning sticker should be attached to the keyboard so as not to give a false impression.

That's it for keyboards. In the next chapter we'll look at mouse repairs.

CHAPTER

12

Mouse Repairs

This chapter covers Macintosh and Lisa mouse repairs. Two OEM mouse numbers are covered:

1. Part# A9M0050—the stock Lisa 2/5 mouse.
2. Part# M0100—the stock Lisa 2/10, Mac XL, 128K, 512K, 512Ke, and Macintosh Plus mouse.

Both models are electrically and physically interchangeable. Even though the Lisa 2/5 mouse has an unusual snap-on DB-9 plug as opposed to a screw-on DB-9 plug, it fits the standard 128K to Mac Plus mouse connector just fine. The converse is also true. So, in a pinch, you can always substitute one style for the other.

Both styles have rotating plastic capstans. These have to be kept clean. Otherwise, the mouse pointer becomes erratic.

There's also a SPDT (single pole double throw) microswitch under each mouse button. Due to dust and hard use, these switches develop intermittents and sometimes break altogether. When they do, clicking becomes erratic or simply stops working.

Rough or unstable tracking, a third common problem, has to do with worn mouse feet.

A fourth problem has to do with electrically intermittent cables.

This chapter goes beyond routine mouse cleaning, shows how to replace a mouse switch, tells how to compensate for worn mouse feet, and shows how to troubleshoot intermittent cables. \$100 or more for a new mouse? Never! Not with this information.

Standard Safety Precautions

For the benefit of someone who just turned to this page and hasn't read the other chapters yet...

To prevent almost certain damage to the logic board, and to minimize the possibility of electric shock, always switch off the power and physically disconnect the mouse cable from the computer before beginning repairs. Switching off the power *before* disconnecting the mouse cable (or any peripheral cable, for that matter) is very important. Although 128K to Macintosh Plus computers seem to tolerate "live" disconnects, the Macintosh SE and the Macintosh II generally do not. Develop good safety habits now, and you'll never have to worry about costly live disconnects later on. Switch off the power before you disconnect the mouse cable!

How the Mouse Works

The mouse is an easily understood electromechanical device. Inside are four light sources, four light sensors, three steel axles, simple friction gears, and a 1-inch diameter rubber-coated steel ball. These parts are illustrated in Figure 12-1. Moving the mouse on a flat surface rolls a ball which turns two plastic capstans. The capstans look like 2-A silicon diodes. Each capstan rotates an axle connected to a slotted disk called an interrupter wheel. These resemble tiny pinwheels. As the wheels turn, tiny beams of light aimed at the photoelectric sensors are continuously interrupted, producing a strobe light. The strobe effect is converted to an electric pulse which moves the mouse pointer across the display.

For top performance, it's imperative that the capstan bearings, the interrupter slots, and the other mechanical parts be kept free of dust, pollen, and other foreign matter. The only way to do that is to periodically disassemble the mouse.

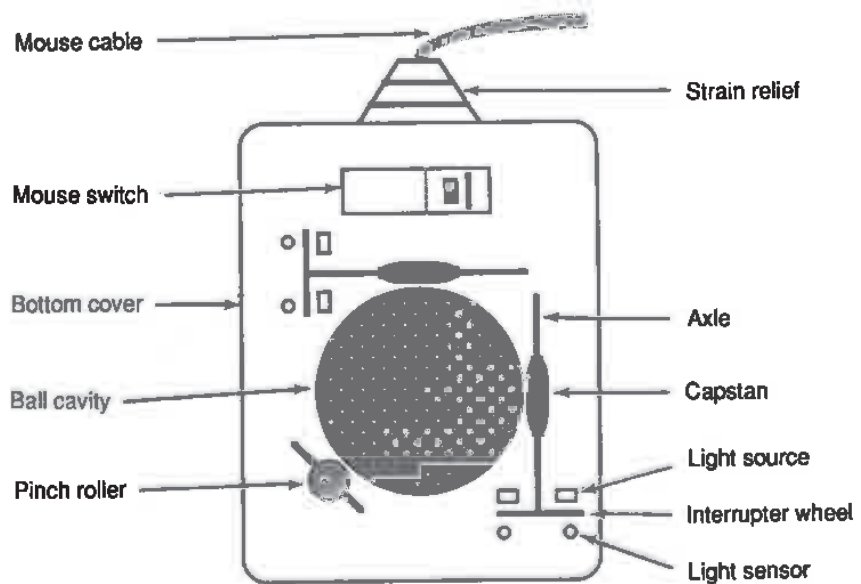

Figure 12-1 Mouse parts. Inside are four light sources, four light sensors, three steel axles, simple friction gears, and a 1-inch diameter rubber-coated steel ball.

Disassembly Procedure

Before beginning, shut down the computer, switch off the power, and disconnect the computer's power cord from the wall outlet. Next, disconnect the mouse cord from the back of the set. Spread out a soft towel, flip the mouse upside down and study the black plastic retaining ring illustrated in Figure 12-2. Note that the bottom of the mouse case is imprinted just above the ring with an L (for Locked) and an O (for Open). In normal use, the marker on the ring points to the locked position. To remove the mouse ball, grip the mouse with two hands, press down on the retaining ring with your thumbs, and turn it counterclockwise until the marker points to the O (for open) position. Flip the mouse right side up, and both parts will slip right into your hand.

Next, loosen the screw or screws in the bottom cover with a #1 Phillips-head screw driver. As shown in Figure 12-3, the 128K to Mac Plus mouse has only one screw, located away from the cord at the bottom of the mouse. The Lisa 2/5, Lisa 2/10 and Mac XL models have two screws located next to the cord at the top of the mouse. After loosening the screws, flip the mouse right side up and shake the loose screws into your hand. If the screws are loose enough, they should fall right out. If not, loosen the screws some more, and try again.

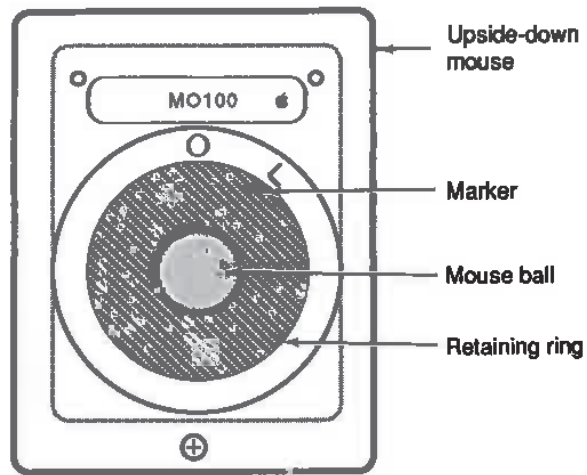

Figure 12-2 Mouse ball. To remove the mouse ball, grip the mouse with two hands, press down on the retaining ring with your thumbs, and turn it counterclockwise until the marker points to the O (for open) position.



Figure 12-3 Loosen the screw or screws in the bottom cover with a #1 Phillips-head screwdriver.

Once the screw or screws are out, you have to exert pressure in the opposite direction of the screw locations in order to release one or two hidden locking tabs. The 128K to Mac Plus mouse has two hidden tabs located next to the cord at the top of the mouse. The Lisa 2/5 mouse has one hidden tab located away from the cord at the bottom of the mouse. Once released, a 128K to Mac Plus mouse cover rotates towards the cord. A Lisa 2/5 mouse cover rotates away from the cord. In general, Lisa 2/5 models come apart much easier. With the 128K to Mac Plus models, you have to push the bottom cover quite a bit forward, towards the cord, while you pull the bottom cover backward, away from the cord, in order to release the tabs.

Once the bottom cover is up, grab the mouse button spring, detach the strain relief from the top cover, and put all three items (the spring, the button, and the top cover) safely aside. It's very important that you put the mouse button spring aside with the top cover. Small springs like this have a habit of bouncing away, never to be found again, unless they are mindfully put somewhere. Inside the top cover is a natural holding area. For reference, the official mouse springs measure $\frac{5}{8}$ -inch long by $\frac{1}{16}$ -inch in diameter. These are about half the size of a retractable ball point pen spring.

On the Lisa 2/5 mouse, this is normally as far as you have to go. The mouse switch is actually part of the cable assembly. It's independently supported by four plastic columns, and it's not necessary to remove the PC board in order to work on it.

On the 128K to Mac Plus mouse, the mouse switch is part of the circuit board assembly. When you need to desolder it, the screw which holds the circuit board to the bottom cover also has to be removed. For reference, note that the circuit board screw will be the smaller of the two mouse screws.

Erratic Mouse Pointer—Mouse Cleaning

If you've been diligently cleaning your mouse according to the official instructions in the owner's manual, you may be surprised by the mass of dust, human hair, and pet fur that's accumulated around the capstans underneath the top cover. When you only remove the mouse ball retaining ring, you never see this stuff. By normal standards, a mouse can look spotless, but that doesn't mean it's clean. This method (total disassembly) reveals everything. Pick out as much of the foreign matter as you can with a pair of tweezers. Blow out the rest with an air compressor or with the exhaust end of a vacuum cleaner. Don't try to vacuum the dust. The mouse mechanism is delicate. You could easily damage it with a stiff vacuum cleaner tool. Now for a real surprise.

As shown in Figure 12-4, the pinch roller and both capstans will appear to be naturally striped—right down the center. These gray stripes are actually mouse ball buildup. They're not supposed to be there! Clean the three parts the same way you'd clean tape recorder capstans. Use cotton swabs dipped

in head cleaner or use a 50/50 solution of isopropyl alcohol diluted with tap water. Scrub away at the gray stripes until they are completely gone.

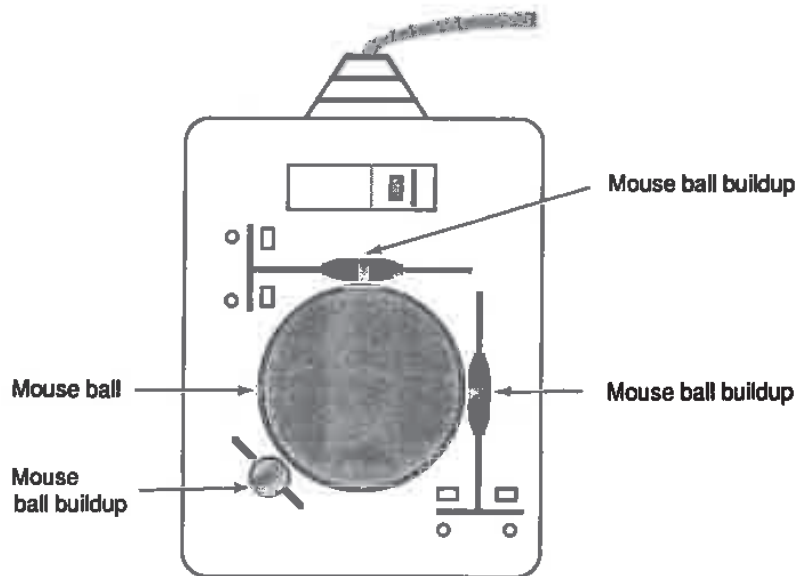

Figure 12-4 Mouse ball buildup. The gray stripes are not supposed to be there!

To check your work, reach inside the mouse ball cavity and spin the three parts. They should rotate freely, like bicycle wheels, through several revolutions. If not, if they barely make it through one revolution, there's probably a stubborn hair or two still trapped somewhere. Check behind the interrupter wheels. Under a good light, you may be able to spot whatever is causing the problem.

If you can't spot anything, and if you can resist over-lubricating, squirt a little WD-40 onto the head of a common pin and try a smidgen on the capstan shafts. Note that you'll have to hold the pin upside down to do this (the head acts like a ladle), so be careful not to stick yourself. Resist spraying WD-40 directly into the mechanism. It's terrific stuff, but it might cloud the photoelectric sensors.

The mouse ball can be cleaned with mild soap and tap water. Rinse it well, and let it air dry. If you try to wipe it dry, the ball will just pick up towel lint.

Reassembly Procedure

In most cases, the thorough cleaning just described is all you need to do to repair a misbehaving mouse pointer. If you've also got a button problem or a cord problem, these should be addressed before reassembling the mouse.

Skip ahead for more information. Otherwise, begin the reassembly procedure by repositioning the strain relief into or on top of the bottom cover. Next, reinstall or reposition the button spring into its retaining well. Note that the Mac Plus mouse button has 2 protrusions. One ends in a star tip. One ends in a point. The star tip goes over the switch. The point goes over the spring. The Lisa 2/5 button is made differently and can go only one way. Lay the mouse button over the switch/spring assembly. Everything will be wiggly, but this is the only way to do it. Now angle the top cover over the strain relief so that the tabs align with the slots. On the Lisa mouse there are no front mounted slots, so all you have to do is engage the strain relief, then poke through the top cover with your finger to adjust the button position, and simultaneously rotate the cover a little towards the back. With the Mac Plus mouse, you have to adjust the button position first. When the tabs on this model interlock, the top cover will snap itself into place. These are precision instructions. If you follow them exactly, you shouldn't have any trouble. Finish up by tightening the cover screw (or screws) with a #1 Phillips-head screwdriver.

When reattaching the cover screws, bear in mind that the covers are made of breakable plastic. To avoid snapping the plastic, always hold the screwdriver between your thumb and index finger. Bear down just enough to snug the screws.

Intermittent Mouse Button—Switch Replacement

A thorough cleaning will almost always cure erratic mouse pointers, but it can't mend worn switch contacts and broken plastic. If the mouse button starts to act up, you'll need to replace the switch. OEM part information is listed in Table 12-1. Note that the Mac Plus mouse is designed for PC (printed-circuit) mounting, while the Lisa 2/5 mouse has solder tabs. This physical difference is illustrated in Figure 12-5.

Table 12-1 Mouse Switch Replacement Data

OEM	Part No	125 V AC	Force	Type
Omron	SS-01-FD	0.1 A	1.8 oz	SPDT PC mount - MO100
Omron	SS-01-FT	0.1 A	1.8 oz	SPDT solder tab - A9M0050
Radio Shack	275-016	5.0 A	5.3 oz	SPDT solder tab - General Purpose
Radio Shack	275-017	5.0 A	5.3 oz	SPDT solder tab - General Purpose

Electrically, either type can be used to replace the other, but the solder tab type needs to be trimmed as shown in Figure 12-5 for use on a Mac Plus mouse board. Take care to do the job right. If the trimmed tabs are the least

bit too wide, they'll damage the traces when you force them through the circuit board. If they're the least bit too tall, the switch will mount too high and after you get everything back together, the mouse button will be permanently depressed. Take a few extra minutes to trim and file the tabs so that they're exactly the same height and width as the original type. Use precision, and you'll only have to do the job once!

After trimming the contacts, the mouse button will be slightly off-center relative to its original location. That's OK. It'll still work exactly the same as before.

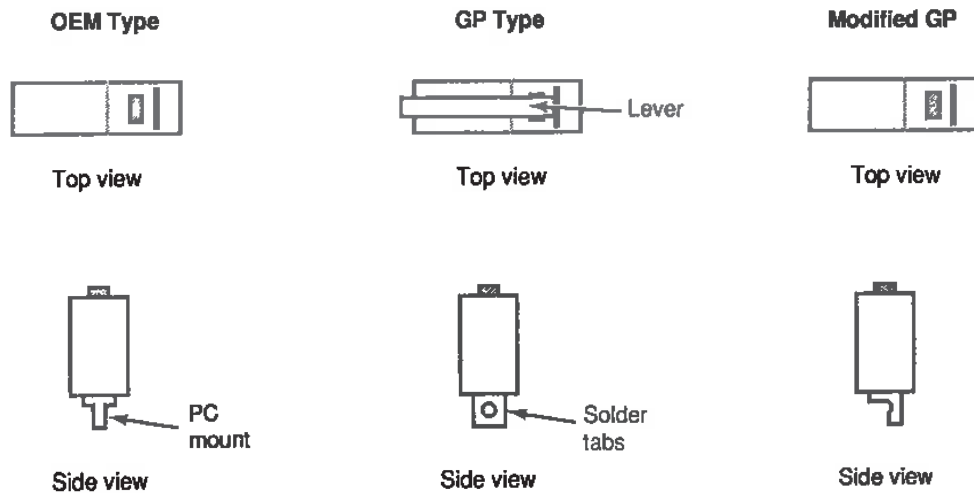

Figure 12-5 Replacement mouse switches. Modify GP (general purpose) types by removing the lever and trimming the solder tabs.

Note that some GP (general purpose) replacements have a higher contact rating and a higher actuation force. You have to press these a little harder, but otherwise they work fine. If there's a lever on the GP switch, remove it by squeezing the hinge.

With inexpensive GP switches readily available, it's not really necessary to test the old switch before replacing it, but since trimming and filing the solder tabs is a spot of work, you may want to confirm that the old switch is bad before buying a new one. Here's how to do it:

Testing the Mouse Switch

1. Turn on your analog multimeter and set it to the $R \times 1K$ scale. Touch the probes together, and zero the needle. If you have a digital meter, turn it on, and set it to read K-ohms.
2. Clip the red probe to one of the active switch tabs and clip the black probe to the other. Ignore the tab that's not wired. Since the mouse

switch is normally open, analog meters should show infinite resistance. Digital meters should indicate overrange.

3. Depress the mouse button. Since that closes the switch, both meters should immediately indicate zero resistance.
4. Now, very, very slowly, release the mouse button. If the switch is good, no matter how slowly you release it, the circuit will always break cleanly. At that point, needle pointers will immediately swing back to infinity; digital readouts will indicate overrange.

If the switch is bad, there'll be a gray area between the two extremes (zero and infinity). Within the gray area, both meters will typically fluctuate between 500 and 5000 Ω .

When that happens during a mouse-down event, the Macintosh (expecting zero ohms) thinks the button is up. The user, of course, still has his finger on the button so he thinks the button is down. To further complicate matters, the slightest lateral pressure can reclose the switch. The result is a generally erratic mouse button. Replace the switch, and the button will be good as new.

Intermittent Mouse Functions

When you intermittently lose all or some mouse functions (no pointer movement, no button response), and you're sure it's not software related, the chances are you've got an intermittent or permanently open wire in the mouse cable. If so, you should be able to make this problem come and go at will by wiggling the ends of the cable. If you can't make this problem come and go by wiggling the cable, try substituting a known good mouse before attempting repairs. It's not that cable repairs are difficult. It's just that more often than not, frozen pointers indicate buggy software. If the substitute mouse fails, that proves the software is at fault. All the cable repairs in the world aren't going to do you any good.

If by wiggling the wire you're able to establish that there's a break at the DB-9 end of the cable, the fix involves cutting the cable 2 inches away from the connector, stripping the wires, and soldering on a new connector. The reason that you have to shorten the cable by 2 inches is to make absolutely sure that you eliminate the break. Experience shows that most breaks occur a short distance away from a stress point, not precisely at the stress point. Cutting away 2 inches of cable with the old connector is standard procedure.

When the intermittent wire is at the mouse end, not the DB-9 end, it's best to shorten the cable by 8 inches. Long before you buy them, typical mouse cables are tightly bound with one or more tie wraps, and stuffed into a styrofoam shipping compartment. This practice results in metal fatigue which is indicated by a permanently creased mouse cable. As a result of the way the mouse is moved, breaks occurring at the mouse end of the cable are generally associated with the first crease occurring 5 to 6 inches from the

mouse body. Since the stressed area generally extends 2 inches from the crease in both directions, at least 8 inches of cable have to be cut away or the mouse will just break again, in very short order.

The wiring diagram for a new 128K to Mac Plus mouse connector is shown in Figure 12-6. The wiring diagram for a new Lisa 2/5 mouse connector is shown in Figure 12-7. For general soldering information, refer to Chapter 11, "Keyboard Repairs."

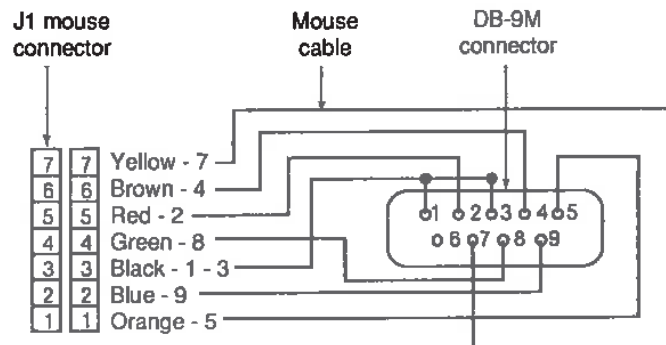

Figure 12-6 Wiring diagram for the Lisa 2/10, Mac XL, and 128K to Mac Plus mouse connector. Diagram shows the outside view of a molded cable, just as it would appear when making a continuity test.

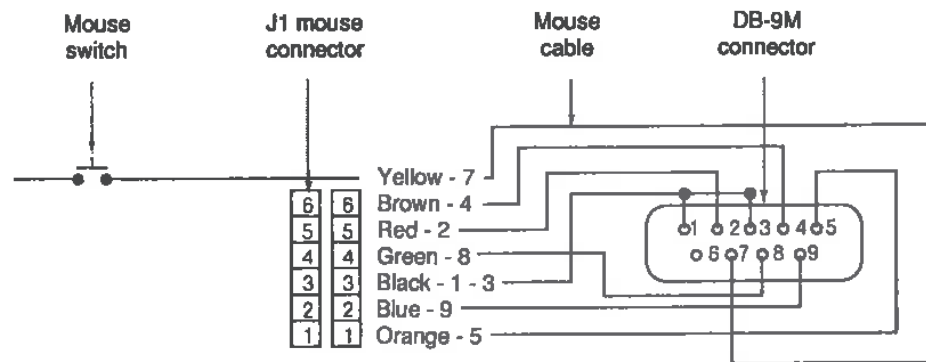

Figure 12-7 Wiring diagram for the Lisa 2/5 mouse connector. Diagram shows the outside view of a molded cable, just as it would appear when making a continuity test.

Dead Mouse

To assist in troubleshooting specific mouse failures, the mouse cable color codes are given in Table 12-2. In the case of a dead mouse, you'd suspect either

the red (+5.00 V) or the black (ground) wire. By testing each wire for continuity, you can easily determine which of the wires, if any, is broken.

Table 12-2 Mouse Cable Color Codes

DB-9 pin	Wire Color	Function	J1-Mouse Pin
1	Black	Ground	3
2	Red	+5.00 V	5
3	Black	Ground	3
4	Brown	Left	6
5	Orange	Right	1
6	N/C	N/A	N/C
7	Yellow	Switch	7 (hard-wired on Lisa 2/5 mouse)
8	Green	Down	4
9	Blue	Up	2

Testing the Mouse Cable for Continuity

1. Turn on your analog multimeter and set it to the R \times 1K scale. Touch the probes together, and zero the needle. If you have a digital meter, turn it on, and set it to read K-ohms.
2. Insert the black probe into pin-1 of the J1-mouse connector, and touch the red probe to pin-1 of the DB-9 connector. If the wire is good, both meters should indicate zero resistance. If either meter indicates infinity or overrange, there's a break in the wire. In that case, you found the problem!
3. If not, repeat step two for all the remaining wires.

If none of the wires tests open, use the same techniques described in Chapter 4 to treat the J-1 mouse connector. If it's tarnished, just disconnecting and reconnecting it may scrape the metal enough to reestablish contact. If so, polish the pins, treat them with stabilant, and that intermittent will be gone.

Rough, Unstable Tracking—Worn Mouse Feet

As shown in Figure 12-8, the mouse is designed to ride on two plastic pins otherwise known as mouse feet. These pins keep the front end elevated. As the feet wear down, the front end gets lower and lower, and eventually the mouse begins to ride on the edge of the mouse ball retaining ring. This results in rough, wobbly tracking. The fix is to apply a set of commercial stick-on

mouse feet. These are made from Teflon, a registered trademark of E. I. Dupont, and measure approximately 69 mils thick by $\frac{13}{32}$ inch in diameter.

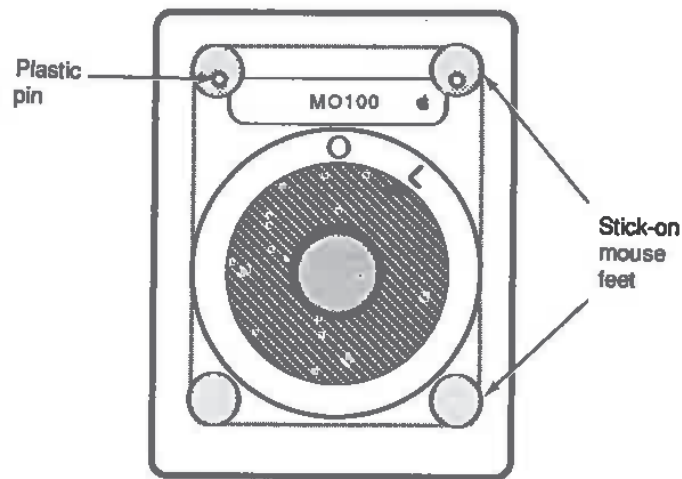

Figure 12-8 Replacement mouse feet measure approximately 69 mils thick by $\frac{13}{32}$ inch in diameter. Lower two feet should be skipped on the Lisa 2/5 mouse.

To give yourself some idea of how well they work, you can cut a makeshift set from stick-on felt or from the loop end of a stick-on hook and loop nylon fastener. You can even use double-sided foam tape, provided that you leave the waxed paper in place on one side. None of the makeshift sets work nearly as well as the commercial product, but they might tide you over a few days and get you past a rough spot. With a new set of feet, the mouse will track better than ever.

Summary

OEM Lisa 2/5, Mac XL, and 128K to Macintosh Plus mice have rotating plastic capstans. These have to be kept clean or the mouse pointer becomes erratic. Clicking problems are related to the button switch. Intermittent cables can usually be repaired with a new DB-9 connector. Rough or unstable tracking can easily be corrected with a set of stick-on mouse feet.

That's it for mouse repairs. In the next chapter we'll take a close look at the Lisa and the Mac XL.

CHAPTER

13

Lisa/Macintosh XL Repair Secrets

Many people believe that Lisas and Macintosh XL's are exactly the same computer. In truth, Lisas and XL's only look the same. There are three different models in the series. The Macintosh XL (a.k.a. Lisa 2/10) is simply the newest model. Since there are major differences between the models, it's important to determine which Lisa/Mac XL you own before beginning any upgrade or repair work.

Identifying the Models

This section lists the official hardware configurations. Hardware means a specific combination of drives, boards, and so on. By identifying what hardware is inside the box, you can easily determine which model of the Lisa you own. Table 13-1 provides a checklist. The next section provides illustrated disassembly instructions so that you can match your particular hardware configuration against the list.

Lisa 1: The Lisa 1 has two DS 5.25-inch disk drives but no internal hard drive. There are two 5.25-inch disk drive openings in the front panel. The Lisa 1 is easy to spot. If you have 5.25-inch floppy disks and two disk drive openings in the front panel, yours is definitely a Lisa 1.

Lisa 2: The Lisa 2 has one 3.5-inch 400K disk drive, different disk drive controller circuitry, and a redesigned front panel to accommodate the

single 3.5-inch drive opening. A 400K floppy controller, labeled the "Lisa Lite Adapter," is mounted inside the disk drive cage. The System I/O board is socketed for an AMD 9512 arithmetic processor. It has nickel-cadmium battery backup for the real time clock. One 512K memory board is standard. The mother board has a mouse connector, two serial connectors, and an external parallel connector. The power supply is rated 1.2 A. The required operating system is called Lisa OS. The official disks generally have violet labels. If you have 3.5-inch disks and one floppy drive opening, yours is at least a Lisa 2.

Lisa 2/5: The Lisa 2/5 was bundled with a 5MB external hard drive or at dealer option, a 10MB external hard drive. Otherwise, it's a Lisa 2, bundled with Lisa OS, exactly the same as above. If you have one or more external hard drives, but no internal hard drive, yours is probably a Lisa 2/5, even if your external drives are 10MB models.

Lisa 2/10: The Lisa 2/10 has a completely different mother board. The mouse connector is different. There's no external parallel connector on the back of the computer. Instead, there's an internal parallel connector and a 10MB internal hard drive. An interrupt switch has been added. The system I/O board is also different. There's no socket for the AMD 9512 coprocessor. There's no nickel-cadmium battery backup for the real time clock. The disk drive controller is different. An extra chip on the I/O board replaces the Lisa Lite Adapter which was formerly located in the drive cage. The disk drive cabling is different. The wiring harness is different. The power supply is different. One megabyte of RAM is standard. If you have Lisa OS disks, a 10MB internal hard drive, no Lisa Lite card, no external parallel connector, and a 1.8-A 110/220-V power supply, yours is at least a Lisa 2/10.

Macintosh XL: The Macintosh XL is exactly the same as a Lisa 2/10. Only the sticker on the box, the operating system, and the instruction manuals are different. Instead of Lisa OS, the bundled OS is Macintosh System software and MacWorks XL, a Lisa program which allows 64K Macintosh ROM emulation. If you have MacWorks XL instead of Lisa OS disks, a 10MB internal hard drive, no Lisa Lite card, and a 1.8-A power supply, yours is probably a Macintosh XL.

Regardless of which model you own, all three Lisa/XL's are easily repaired. The next two sections show how to get a dead Lisa going again. The section after that shows how to turn it into a super deluxe, big-screen Macintosh Plus.

Table 13-1 Hardware Configuration Checklist

This sample table reflects a fully upgraded Lisa 2/5

Item	Check	Model#/Notes
400K internal floppy		
800K internal floppy	✓	Sony# MPF-51W
Lite adapter	✓	Apple# 620-149
Internal hard drive	✓	Miniscribe/Sun 20MB
1.2-A power supply		
1.8-A power supply	✓	Jumpered for 110 V AC
System I/O board	✓	Apple# 620-0117 (Lisa 2/5)
CPU board	✓	Apple# 620-0119
Memory 1 board	✓	Apple# 620-0112 (512K)
Memory 2 board	✓	Apple# 620-0112 (512K)
Screen kit transformer	✓	Properly installed
ROM version	✓	3A/A8 (XL screen kit)

Lisa/XL Disassembly Procedure

All Lisa/XL models are built on the same chassis and come apart the same way, without tools. Before beginning, shut down the Lisa (if it's on) and physically disconnect the power cord from the back of the computer. To remove the front panel place your hands along the bottom edge, feel for the two finger grips, and push up gently as shown in Figure 13-1. Pushing up disengages two plastic tabs, swings the front panel forward, and opens a safety switch in the upper left corner of the chassis. If the computer is on, removing the front panel will immediately turn it off. Since this is not the recommended way to power down, always remember to *Save* your work and *Shut Down* before removing the panel.

The disk-drive assembly is held in place by a spring-loaded knurled nut as shown in Figure 13-2. To remove the entire disk-drive cage, loosen the nut until it springs free and then pull straight back. The cage slips out easily. Normally, the wiring harness is just long enough to allow you to set the assembly down in front of the computer. Take care not to snag or overextend the drive cables. As shown in Figure 13-3, there's not much slack!

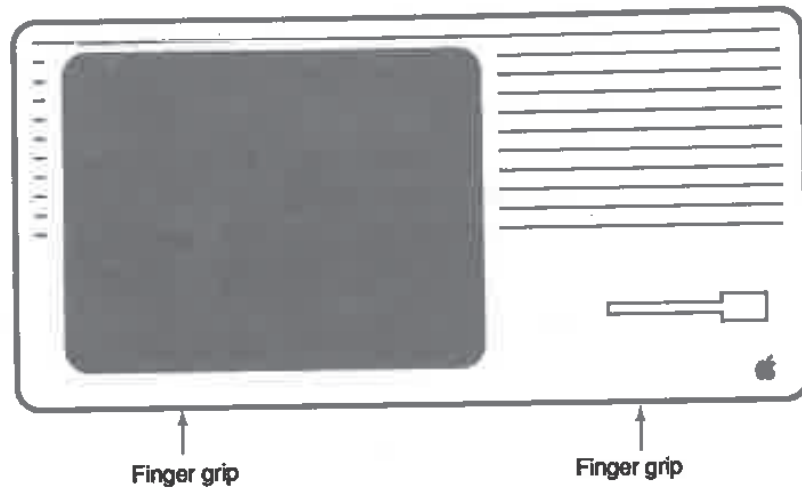

Figure 13-1 To remove the front panel, feel for the finger grips at the bottom edge and push up gently.

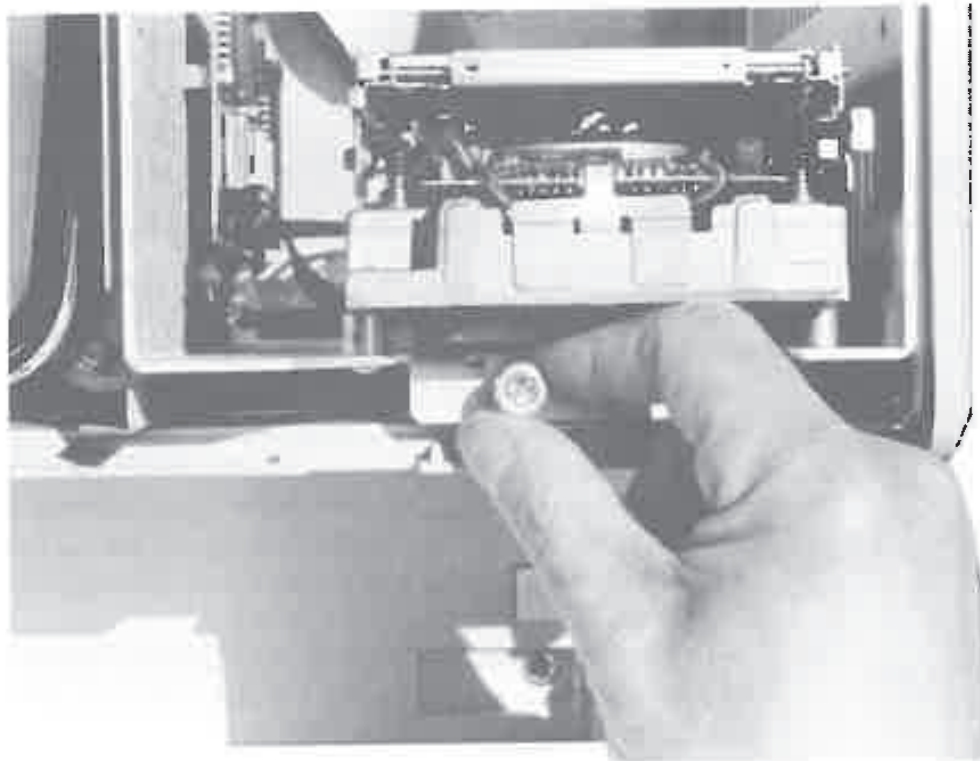

Figure 13-2 To remove the entire disk drive cage, loosen this retaining nut until it springs free and then pull straight back.

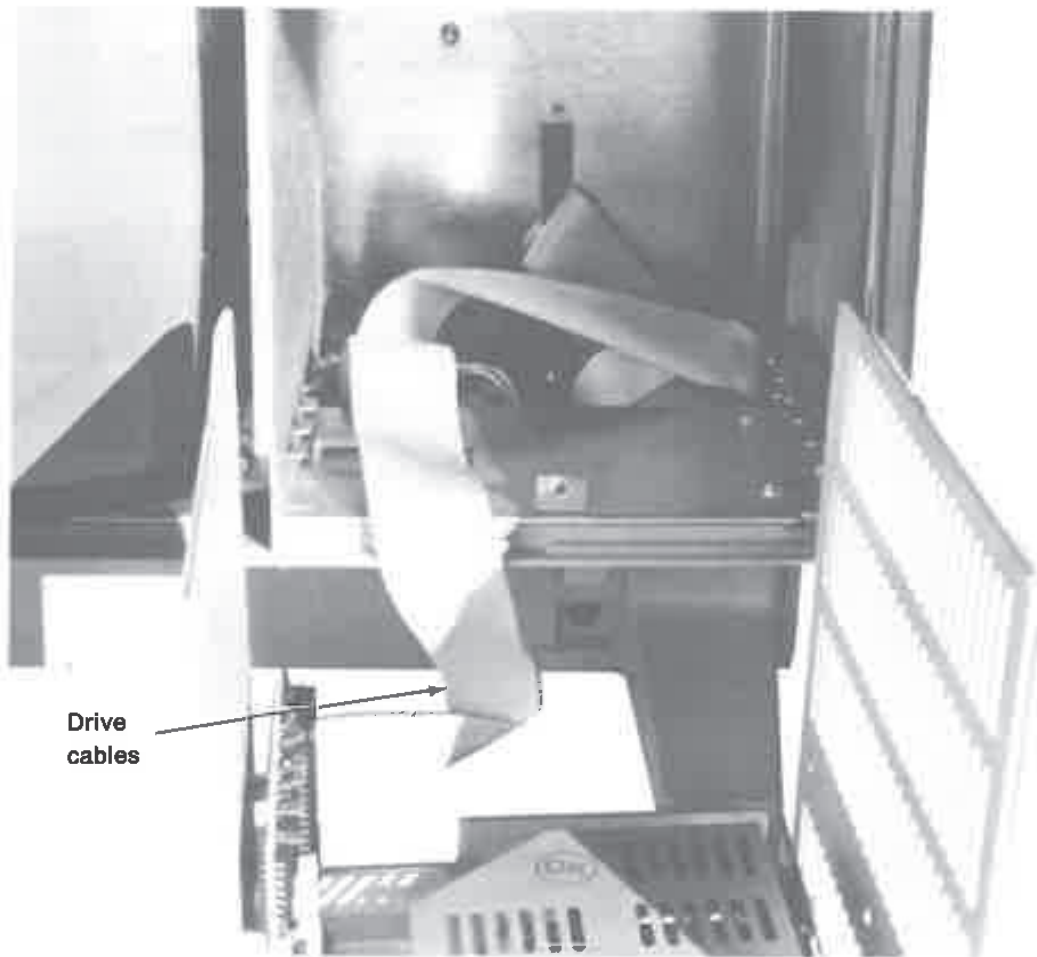

Figure 13-3 When removing the disk drive assembly take care not to snag or overextend the drive cables. There's not much slack!

Once the drive cage is out, note whether the floppy drive ribbon cable is routed to a connector at the back of the cage or whether it's connected to a Lisa Lite Adapter as in Figure 13-3. A Lite Adapter indicates that the computer is either a Lisa 2 or a Lisa 2/5. Direct connection suggests a Lisa 2/10 or a Mac XL.

You can remove the internal disk drive by tilting the drive cage forward and loosening four screws at the bottom. Hard drives, when present, are held by five or six screws along the side.

400K Sony drives are identified by part numbers beginning with OA-D34V. 800K Sony drives are identified by part numbers beginning with MPF-51W. You might also find an 800K Chinnon drive in a Lisa. These will clearly be marked "Chinnon."

Original 10MB Widget drives are marked "Apple computer." Other internal hard drives might be marked "Fujitsu," "Kalok," "Miniscribe," or "Seagate." For reference, write down the make and model numbers of whatever drives you find.

The rear panel is held on by two thumbscrews. Turning the thumbscrew counterclockwise disengages a metal retaining tab. Note that it's not necessary to remove the thumbscrews. With a little loosening, you can pull the rear panel back and lift it away. This procedure is shown in Figure 13-4.

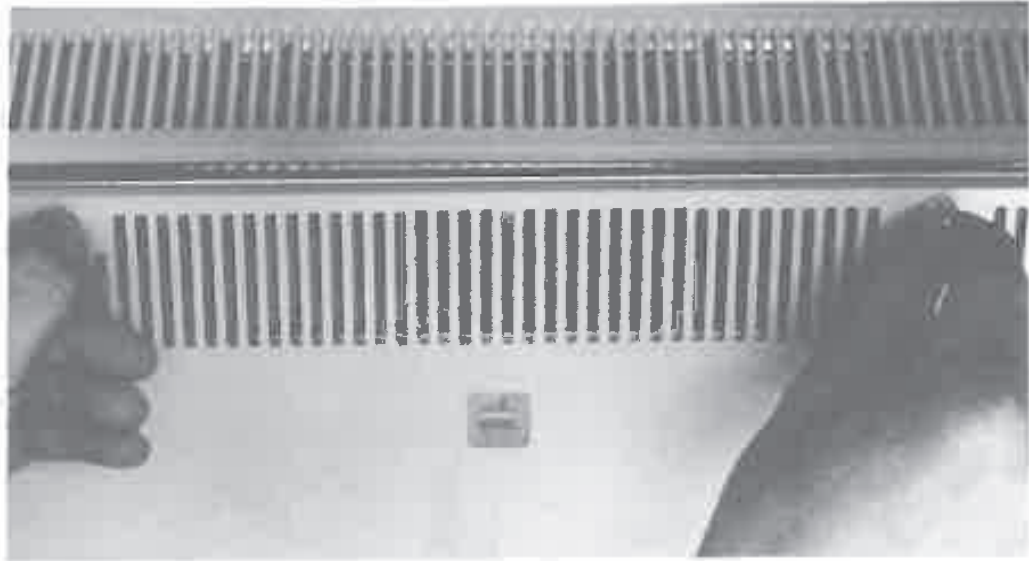

Figure 13-4 To remove the rear panel, first disconnect the power cord and all peripheral cables, then turn the thumbscrews counterclockwise, pull slightly, and lift at an angle.

Removing the rear panel opens a second safety switch in the upper right-hand corner of the chassis. If the computer is on, removing the rear panel also turns it off. Safety switches protect the computer as well as the operator. It's possible to defeat safety switches (the cap of a ball point pen works well) but be careful. Removing cards without turning the power off first is a surefire way to destroy them.

Note that pressing the on/off switch or removing the covers (engaging the safety switches) does not remove all power to the computer. The only way power can be completely removed is by unplugging the line cord.

The power supply is attached by a second spring-loaded, knurled nut as shown in Figure 13-5. Once you loosen the nut it may take considerable force to remove the supply. Because of a tight-fitting tongue and socket connector, that's normal. If the connector fits loosely, the operating voltages might fluctuate and the computer would be subject to intermittent operation.

Fortunately, it's very well made. When you need to remove the power supply, loosen the finger nut (until it springs free) and pull straight back. When you need to replace the power supply, push it in $\frac{1}{4}$ inch past the resistance point, until the center of the nut is located approximately $\frac{1}{2}$ inch from the edge of the chassis.



Figure 13-5 To remove the power supply, loosen the finger nut and pull straight back. Note that the nut is located approximately $\frac{1}{2}$ inch from the edge of the chassis.

As shown in Figure 13-6 to 13-7, 1.8-A (ampere) power supplies are identified by part number 699-0189. 1.2-A power supplies are identified by part number 620-6103. Both supplies are marked "120 V AC 150 W," but the 1.8-A model is actually a dual voltage (110/220-V AC) model, and it's also 50% stronger!

Here are the figures: Power = Voltage \times Current. Substituting Lisa 2/10 to Mac XL power supply values: 120 V AC \times 1.8 A = 216 W (44% over specification). Substituting Lisa 2/5 power supply values: 120 V AC \times 1.2 A = 144 W (4% under specification).

So how can both models be marked 150 W? The acceptable input voltage specified in the Lisa 2 literature is 90 V AC to 130 V AC. Substituting 90 V AC (the low limit) into the Lisa 2/10 to Mac XL supply's formula (90 V AC \times 1.8 A) lowers its relatively high rating to 162 W. Substituting 130 V AC (the high limit) into the Lisa supply's formula (130 V AC \times 1.2 A) raises its relatively low rating to 156 W. Since both figures exceed 150 W, that presumably explains the identical ratings. Nevertheless, the Lisa 2/10 to Mac XL supply is notably superior.



Figure 13-6 Lisa/Mac XL power supplies—external views. 1.8-A Lisa 2/10 to Mac XL power supply (left), and 1.2-A Lisa 2/5 power supply (right) are both marked “150W,” but the 1.8-A model is actually a dual voltage model, and it’s 50% stronger!

When the original 1.2-A Lisa 2/5 supply is used with an internal hard drive and a Macintosh XL Screen Kit (described at the end of this chapter), audible transformer ringing results, horizontal retrace lines become noticeable, and a slight screen flicker is introduced. Installing the 1.8-A Lisa 2/10 to Mac XL supply eliminates all of that.

The 1.8-A Lisa 2/10 to Mac XL supply is also a dual voltage model. 110- to 220-V AC conversion is made by moving two jumpers at the bottom of the board, as shown in Figure 13-8.

These differences make a very important point. If you only remember one thing from this book, it should be this: Always confirm specifications by making your own calculations.

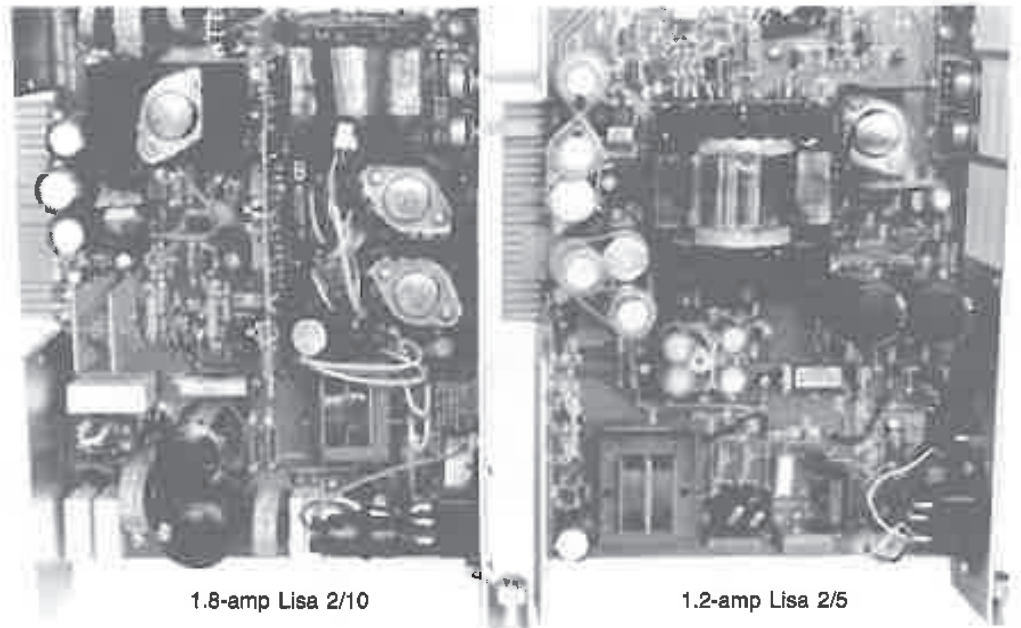

Figure 13-7 Lisa/Mac XL power supplies—internal views. 1.8-A Lisa 2/10 to Mac XL power supply is shown on the left. 1.2-A Lisa 2/5 power supply is shown on the right. Note the three power transistors and the extra large filter caps in the Lisa 2/10 to Mac XL model.

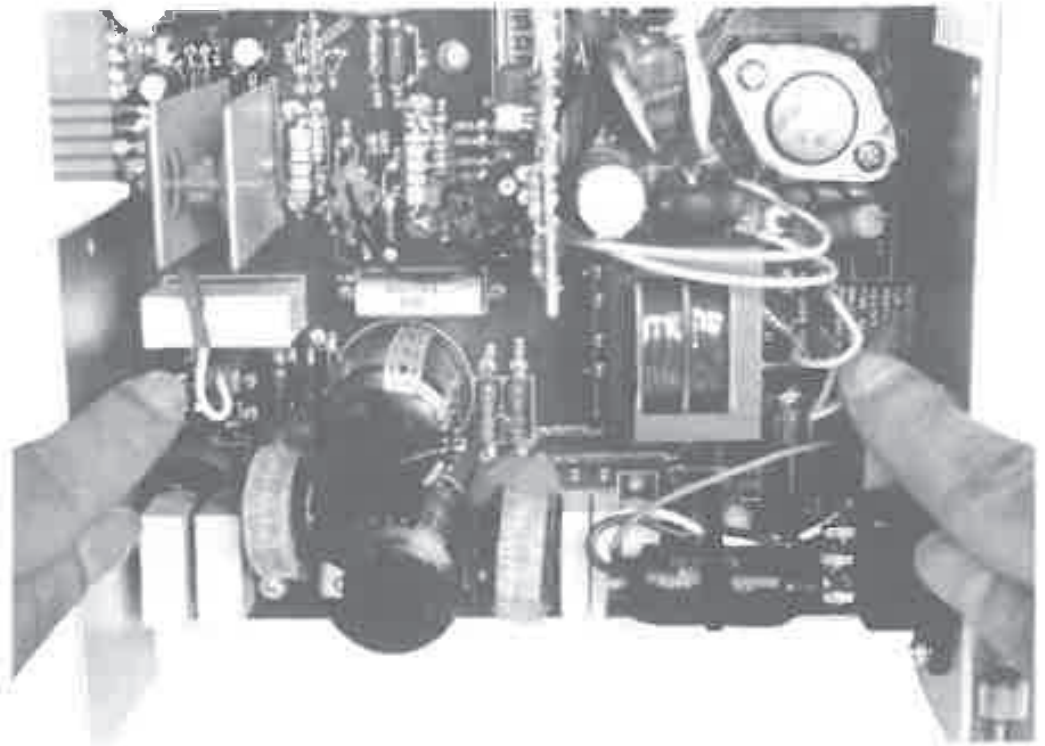

Figure 13-8 Lisa 2/10 to Mac XL power supply—110- to 220-V AC conversion (1.8-A model, only) is made by moving two jumpers at the bottom of the circuit board.

The card cage is a removable rack for the Lisa's circuit cards. It's also held by tight-fitting tongue and socket connectors. To remove it, disconnect all peripheral cables from the back of the computer, brace your thumbs underneath and pull straight back as shown in Figure 13-9.

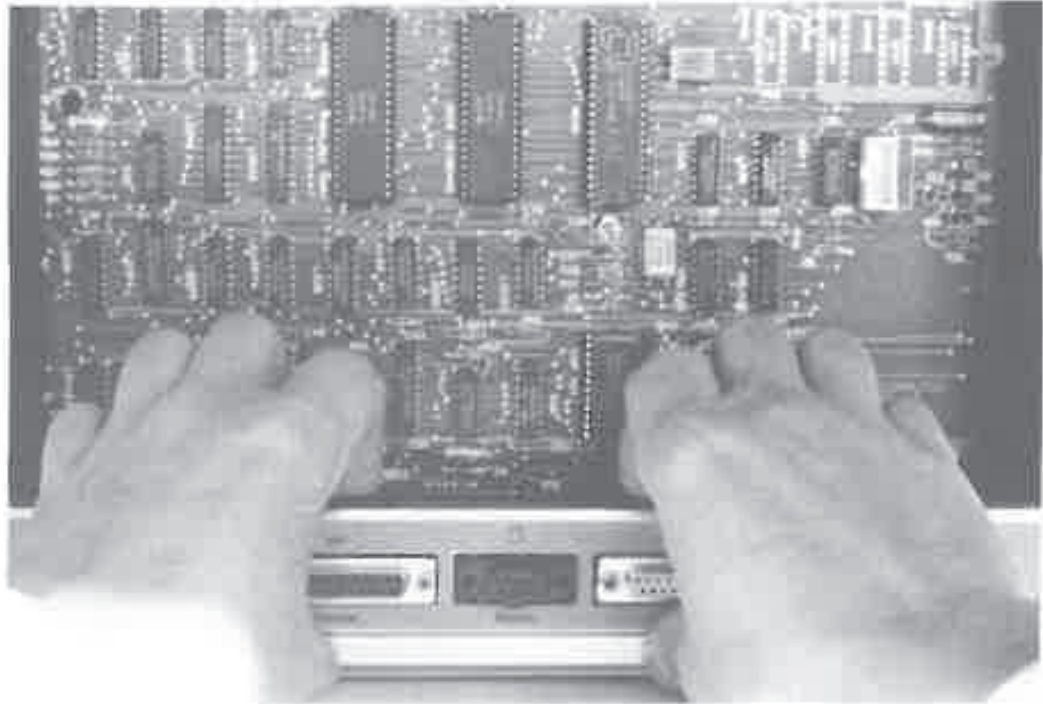

Figure 13-9 To remove the card cage, brace your thumbs and pull straight back.

The mother board is fixed to the bottom of the cage and there may be three or four removable cards (depending on how much memory you have) arranged vertically, from back to front, as shown in Table 13-2.

Table 13-2 Replaceable circuit cards

Card	Lisa Part#	XL Part#	Color Code
System I/O	620-0117	620-142	Red & brown
CPU	620-0119	620-0119	Blue & brown
Memory 1	620-0112	620-0112	Yellow & brown
Memory 2	620-0112	620-0112	Yellow & brown

Note that part numbers beginning with 620 refer to a complete circuit card (defined as a plug-in circuit board with all the parts on it), not an empty board, which is always referred to by another number beginning with 820. All four cards fit into tongue and socket connectors on the mother board. To remove a card, loosen the color coded bails and pull straight up. The four cards slip in and out easily, and the design makes it impossible to reinstall them backwards; although, it's very easy to get confused. Note that the CPU card faces backward, while the System I/O card faces forward. If the CPU card offers the least bit resistance when you try to put it in, it means you're holding it wrong. Don't force anything! Check the color codes as illustrated in Figure 13-10.

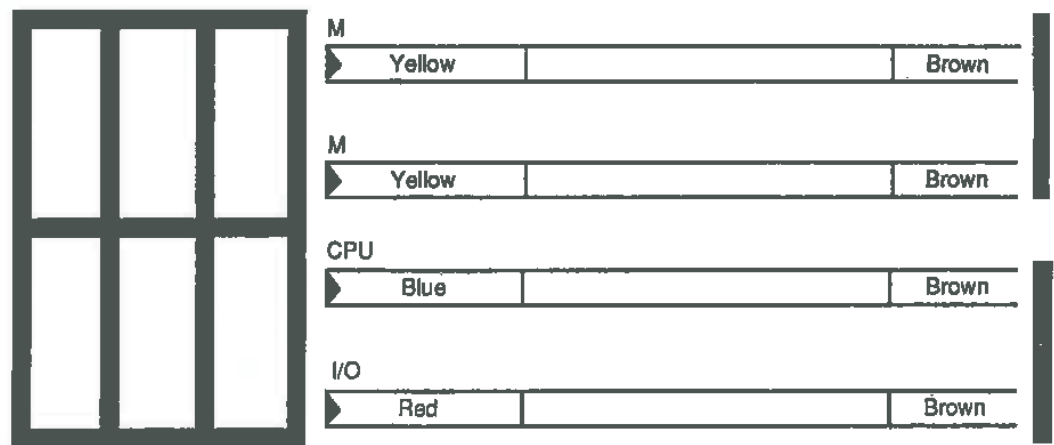

Figure 13-10 Top view of the Lisa/XL card cage.
Bail colors indicate proper orientation.

The Memory cards and the CPU card on Lisas and Mac XL's are interchangeable. The System I/O cards are not. Physically, they fit, but electrically there are problems with disk-drive control. If you just bought a used Lisa, or if you're restoring a Lisa and can't seem to get it going, it's important to check for the correct System I/O card. The differences are shown in Figures 13-11 and 13-12.

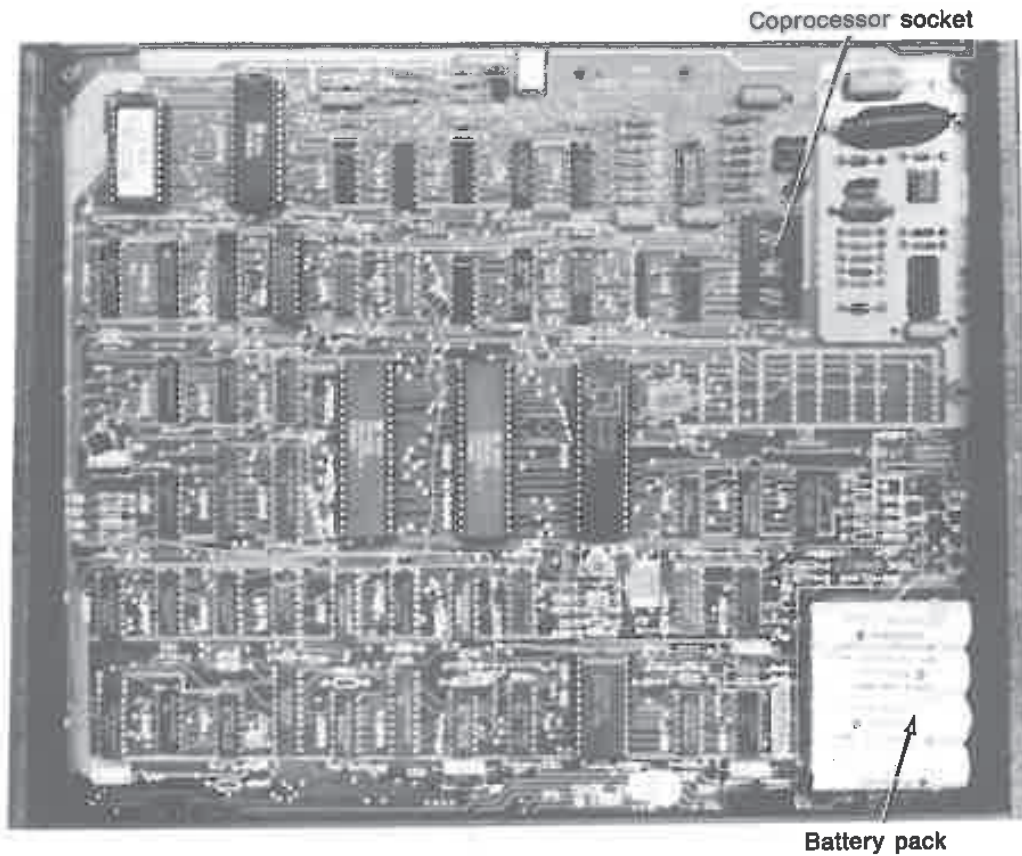

Figure 13-11 The Lisa I/O card. Note the battery pack (lower right) and the AMD 9512 coprocessor socket (upper right).

While the card cage is out, peek inside the chamber and find the two hidden screw holes on the underside of the top cover as shown in Figure 13-13. When you need to remove the top cover, use a #2 Phillips-head screwdriver to loosen the screws until they dangle, then slide the cover forward and lift straight up. Both screws are permanently attached to the chassis. You don't have to worry about them falling out.

Once you've determined that the hardware configuration is correct, the Lisa's automatic startup tests will tell you if everything is working OK. It's important to verify the hardware setup before proceeding, because if the wrong boards are in your machine, the test results may be invalid.

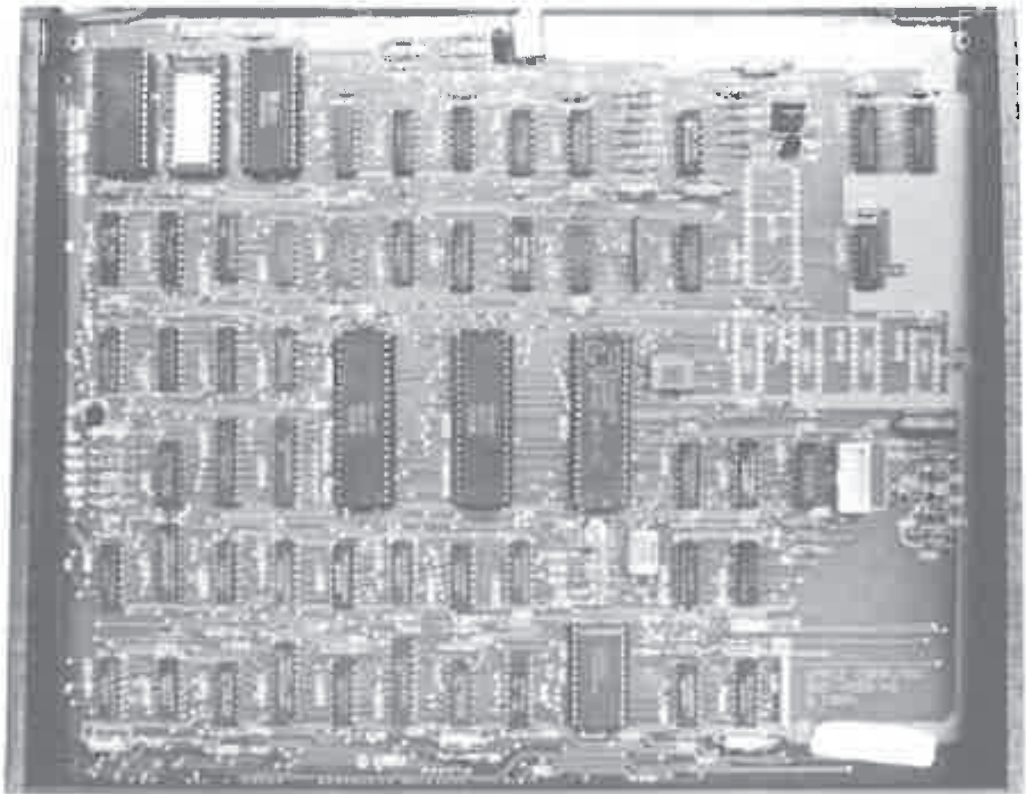

Figure 13-12 The Mac XL I/O card. There's no battery pack (lower right) and no socket for the AMD 9512 coprocessor (upper right)!

Automatic Startup Tests

Every time you turn on the Lisa, it runs an exhaustive series of tests in the following sequence:

ROM Checksum

If the ROM Checksum fails, the computer hangs. When the CRT warms up, the screen may appear blank or it may display random patterns. These symptoms indicate a problem with the ROM chips, which are on the CPU board at locations D13 and D14. There are several things to check before ordering new ROMs:

1. Make sure the chips are oriented correctly. The notches should be pointing up. There were several ROM versions. Someone could have tried to install new ROMs, put them in backwards, and given up at that point.

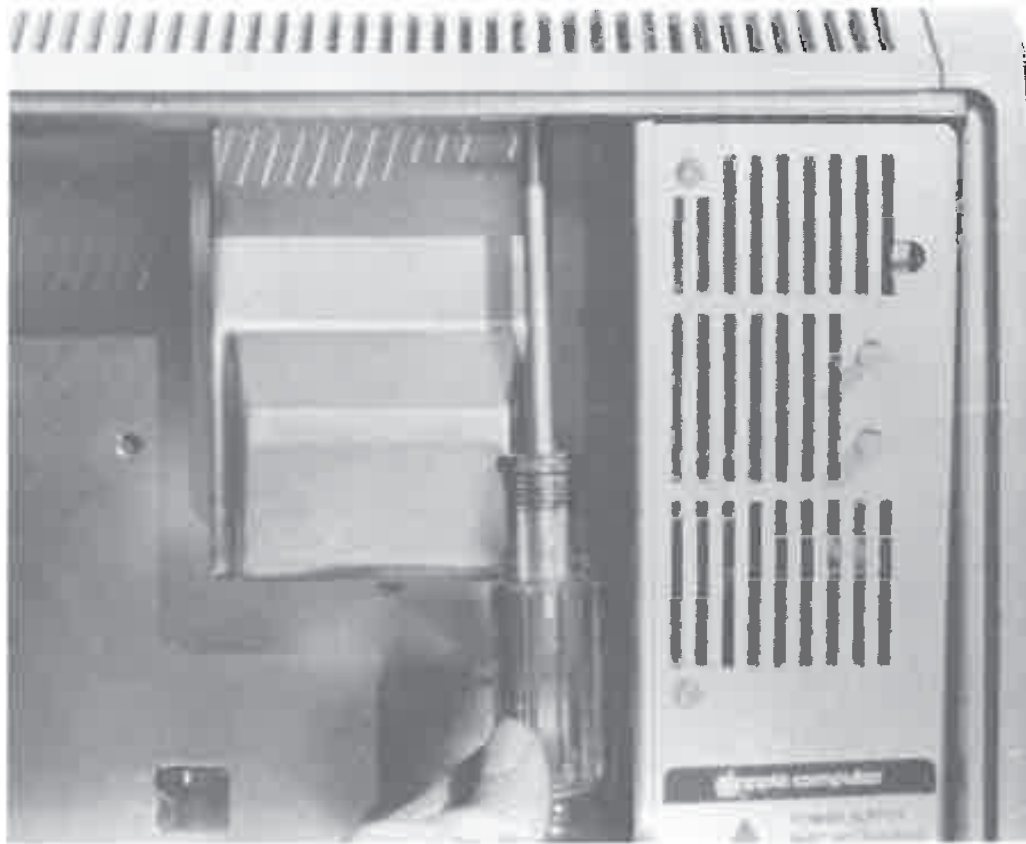

Figure 13-13 The top cover is removed by loosening two hidden screws attached to the roof of the chamber. Both screws are permanently attached to the chassis. They won't fall out!

2. Make sure they're in the right sockets. If you have a stock Lisa with "H" ROMs, part number 341-0176-H should be in the socket at D14, part number 341-0175-H should be in the socket at D13. If you have a modified Lisa with "3A" ROMs, part number 341-0346 should be in the socket at D14, part number 341-0347 should be in the socket at D13. Any other part numbers indicate old (buggy) ROMs. Replace these on principle. It's usually not necessary to buy ROMs separately. The latest 3A ROMs are included with the XL Screen Kit, a video upgrade described later in this chapter.
3. Make sure there are no bent pins on the ROMs.
4. Make sure both chips are fully seated.

If you find any one of the above problems, pull the chips, replace them, reorient them, and/or straighten the pins as necessary.

MMU Register Test

An initial failure of the MMU Register Test causes an endless loop. When the CRT warms up, it'll be blank. Other failures display error code 40 and show a cross over the CPU board icon. (Refer to Table 13-3.) Both symptoms indicate a problem in the memory management unit, which is made up of various static RAM chips. Each of these components is soldered in place which makes substitution very difficult.

When the MMU Register Test fails, make sure the CPU board is seated firmly, check for any obvious bad solder joints, and if that doesn't turn up anything, replace the board.

Memory Sizing

This test counts the installed memory. Errors are pretty much ignored, but if the memory can't be accessed at all, say both cards are missing, the speaker beeps, and the computer hangs with a series of alternating black and white stripes. The pattern is shown in Figure 13-14.

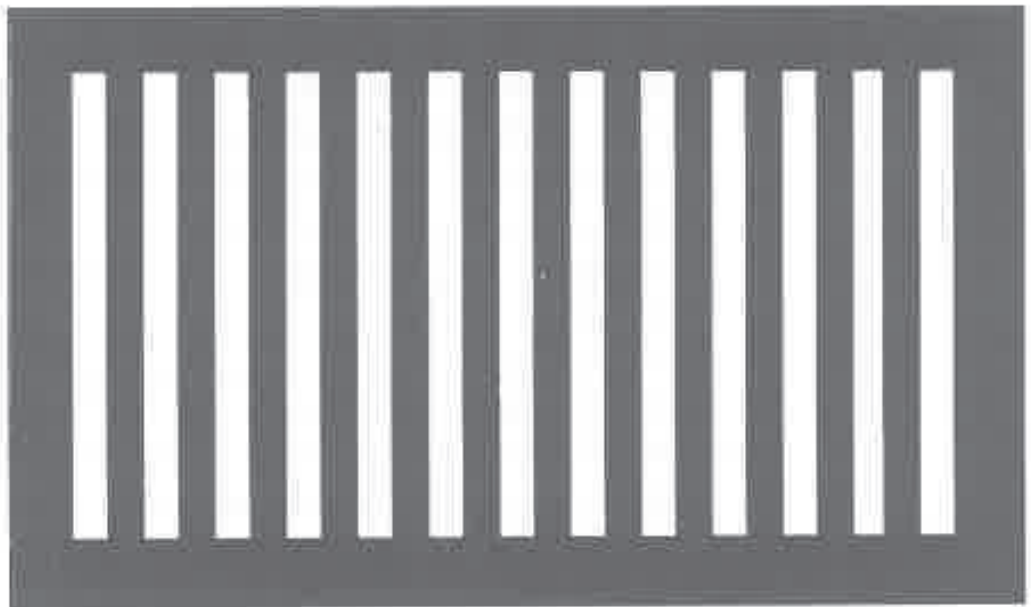

Figure 13-14 This pattern indicates total RAM failure. On the Lisa, Mac XL, Mac Plus, and Mac SE it generally means the cards and/or SIMMs are missing. On the 128K to 512Ke with certain memory upgrades, it generally indicates a problem with the 68000 chip.

The fix is to install or reset the cards. If necessary, clean the contacts with a pencil eraser. They're gold plated so they should be nice and shiny. Try not to touch the contacts with your fingers. It's best to keep them oil-free.

Preliminary Memory Test

The startup ROM uses the first 2K of memory. If there's a problem with the first 2K, the speaker beeps twice and the computer hangs with a random display on the screen. This indicates a problem with the memory card in slot 1, the slot closest to the middle of the card cage. Verify by removing the card and trying again. So long as there's a second card in slot 2, the slot closest to the edge of the card cage, the computer will still boot, and, assuming that card's OK, testing will continue.

VIA Test

VIA is an acronym for Versatile Interface Adapter. The Lisa uses two 40-pin 6522A chips, the same chip used on other Macs. The chip at D7 (marked "keyboard") provides keyboard logic, a real time clock, and mouse control; the chip at D5 (marked "parallel port") controls the parallel port. Both chips are labeled and socketed.

If this test fails with a cross over the I/O board icon and error code 50 (keyboard VIA problem) or error code 51 (parallel port VIA problem), here's what to do:

1. Make sure the suspect VIA chip is installed. On a used or surplus Lisa, someone might have pulled it!
2. Make sure it's oriented correctly. The notch should be pointing up.
3. Make sure there are no bent pins on the chip.
4. Make sure the chip is fully seated.
5. If that doesn't turn up anything, it's worth trying a new VIA chip before scrapping the board.

The VIA test may also fail with a cross over the I/O board icon and error code 58, indicating an I/O access problem or with a cross over the I/O board icon and error code 41, indicating an I/O decode problem. In either case:

1. Make sure the CPU board is seated firmly.
2. Check for any obvious bad solder joints.
3. Make sure the 68000 is oriented correctly. The notch should be pointing up.
4. Make sure there are no bent pins on the 68000.
5. Make sure it's fully seated.
6. Make sure it's an 8-MHz 68000. Someone may have tried substituting a faster CPU. The OEM part is marked MC68000G8.

If that doesn't turn up anything, it's worth trying a new 68000 before scrapping the board.

I/O Board Tests

I/O is an acronym for Input/Output. If both input devices (the keyboard and mouse) are connected, the speaker emits a single click. Otherwise, you're alerted (by an icon and a series of tones) that they're not connected. The click or the input device alert completes the kernel tests. Up to this point, only two or three seconds will have passed since the power button was pushed. Next, the Lisa runs module tests. When the screen warms up, you'll see a Startup Module Test Display as shown in Figure 13-15.



Figure 13-15 The Startup Module Test Display.

As each module passes, it's marked with a check mark. Errors result in a cross over the module with an error code underneath. A complete list of error codes is given in Table 13-3.

Table 13-3 Startup Error Codes

Code	Icon	Symptom	Solution
N/A	Drive opening	No diskette	Insert disk
23	Diskette	Unreadable diskette	Reformat disk
38	Diskette	No startup file on diskette	Install system
39	Diskette	Drive ROM can't keep up	Wrong drive ROM?
40	CPU card	Memory management problem	
41	CPU card	Selection logic problem	CPU card missing?
42	CPU card	Video circuit problem	
43	CPU card	Parity circuit problem	
44	Lisa	Unexpected NMI interrupt	
45	Lisa	Bus error	
46	Lisa	Address error	
47	Lisa	Unexpected exception	
48	Lisa	Illegal instruction	
49	Lisa	Line 1010 or 1111 trap	
50	I/O board	Keyboard VIA error	6522A chip?
51	I/O board	Parallel VIA error	6522A chip?

Table 13-3 (cont.)

Code	Icon	Symptom	Solution
52	I/O board	I/O COPS error	COPS chip?
53	I/O board	Keyboard COPS error	COPS chip?
54	I/O board	Clock error	
55	I/O board	Serial port A problem	Z 8530 chip?
56	I/O board	Serial port B problem	Z 8530 chip?
57	I/O board	Disk controller problem	Lite Adapter?
58	I/O board	I/O board access error	
59	I/O board	I/O COPS error	
60	I/O board	I/O or keyboard error	
70	Memory board	Read/write error	
71	Memory board	Parity error	
75	Internal HD	System files are damaged	Reinstall System
75	External HD	System files are damaged	Reinstall System
75	Floppy disk	System files are damaged	Reinstall System
75	Expansion card	System files are damaged	Reinstall System
80	Internal HD	Drive cable is disconnected	Check cable
80	External HD	Drive cable is disconnected	Check cable
81	Internal HD	No response from drive	Adjust solenoid?
81	External HD	No response from drive	
82	Internal HD	Drive doesn't answer	
82	External HD	Drive doesn't answer	
83	Internal HD	Other drive problem	
83	External HD	Other drive problem	
84	Internal HD	Boot blocks are damaged	Low level format?
84	External HD	Boot blocks are damaged	Low level format?
85	Internal HD	Drive can't keep up	
85	External HD	Drive can't keep up	
90	Expansion card	No card in that slot	
91	Expansion card	Can't start from that card	
92	Expansion card	Problem with the card ROM	
93	Expansion card	Other card problem	

ROM Identification

Another function of the startup module test is to identify which versions of the ROMs are installed. The version numbers appear in the upper right corner of the screen. The letters and numbers to the left of the divisor refer to the boot

ROM. The letters and numbers to the right of the divisor refer to the drive ROM. A list of what you should see is given in Table 13-4.

Table 13-4 Acceptable Lisa/XL ROM Versions

Version	Computer	Meaning
H/A8	Lisa 2; 2/5	Stock screen—90 × 60 dpi
3A/A8	Lisa 2; 2/5	Modified screen—72 × 72 dpi
H/88	Lisa 2/10; XL	Stock screen—90 × 60 dpi
3A/88	Lisa 2/10; XL	Modified screen—72 × 72 dpi

H/A8 indicates a stock Lisa 2. 3A/A8 notes the presence of an XL screen kit, indicating a modified Lisa 2. H/88 indicates a stock Lisa 2/10 or a Mac XL. 3A/88 indicates the presence of an XL screen kit, indicating a modified Lisa 2/10 or a Modified Mac XL. Watching the ROM codes is the easiest way to determine whether an XL screen kit is installed. For reference, write down whatever codes are displayed.

Booting the Operating System

The next step is to boot an operating system (OS). One of the biggest problems veteran Mac owners have with Lisas and Mac XL's is understanding (conceptually) why this step is necessary. On the Macintosh, half of the OS is loaded transparently from ROM, and the other half loads from a startup disk, defined as any disk containing System and Finder files. It's simple.

The Lisa/Mac XL boot procedure is more complicated, because Lisas were designed to run multiple operating systems (Lisa Office System, Lisa Pascal Workshop, MacWorks XL, MacWorks Plus, etc.). That capability precludes putting half of any particular operating system in ROM. Instead, 100% of whatever OS you choose to run has to be loaded from disk. In practice, the allowable operating systems are permanently installed on one of seven partitioned hard disks, where they load automatically, according to modifiable startup preferences, upon completion of the module tests.

If there's no hard disk connected, or if it's powered down, two buttons appear on the Lisa/XL screen instead. To load MacWorks from a floppy (as might be necessary on the repair bench), click the "Startup From..." button, insert a MacWorks 3.0, MacWorks XL, or MacWorks Plus disk, then click the disk drive icon. If you boot MacWorks 3.0 or MacWorks XL, 64K ROM emulation will load into RAM. If you boot MacWorks Plus, 128K ROM emulation will load into RAM. Upon completion, the MacWorks disk kicks out, and the familiar blinking 3.5-inch floppy disk icon appears. From that point forward, the machine will operate just like any other Macintosh.

One Caveat: Following through with inappropriate versions of the System and Finder will crash the machine. Acceptable System/Finder

combinations for use with MacWorks 3.0 and MacWorks XL include 2.0/4.1 and 3.2/5.3. These are the exact same limitations that 512K Macs have. Additionally, you must load the System and Finder from an MFS (Macintosh File System) disk. HFS (Hierarchical File System) disks are not recognizable on any Mac under the 64K ROMs.

MacWorks Plus requires at least System/Finder 4.2/6.0. In this case, previous versions of the System and Finder result in a crash. The important thing to remember is that system crashes of this nature have nothing to do with the hardware. Once you get to the blinking floppy disk icon, you can assume that the machine is OK.

Built-in Service Mode

In addition to the automatic startup tests, the Lisa has built-in service mode. The built-in service mode is top secret. Very few people know it exists. No one I've spoken to, not even the most knowledgeable Lisa owners and technical support people, has ever seen the documentation. Whether the documentation was lost, or whether it was ever written, remains a mystery. Still, some tests are easy to figure out. Adjust Video, for example, puts up a 1/2-inch reverse video crosshatch.

Here's how to enter the built-in service mode:

1. If the computer is on, turn it off. Wait a few seconds, then without inserting a startup floppy disk, turn the computer on again.
2. At the end of the kernel test (when you hear the first click), hit any key except Caps Lock. Hitting a key interrupts the normal startup procedure and turns on the Startup From mode.
3. At the end of the module test (when you hear the second click), hold down the Apple key and press the 2 key.
4. Since there's no floppy disk in the disk drive, the Lisa beeps three times and presents you with an error box. Ignore it!
5. Hold down the Apple key and press the s key. S presumably stands for service. Case is irrelevant. Pressing S, or s, will engage the service mode as shown in Figure 13-16.

Note that the numerical shortcut keys for the menu items don't require pressing the Apple key. If you'd rather not use the mouse, just press the numerical keys (all by themselves) to engage the tests. Press and, if necessary, hold down the Return key to return to the main menu. Press 7, not Apple Q, to Quit. Press the Reset button at the back of the computer to exit an endless loop.

Without more information, I can only speculate as to the purpose of these tests. My best guess is that they were used on the assembly line for quality control.

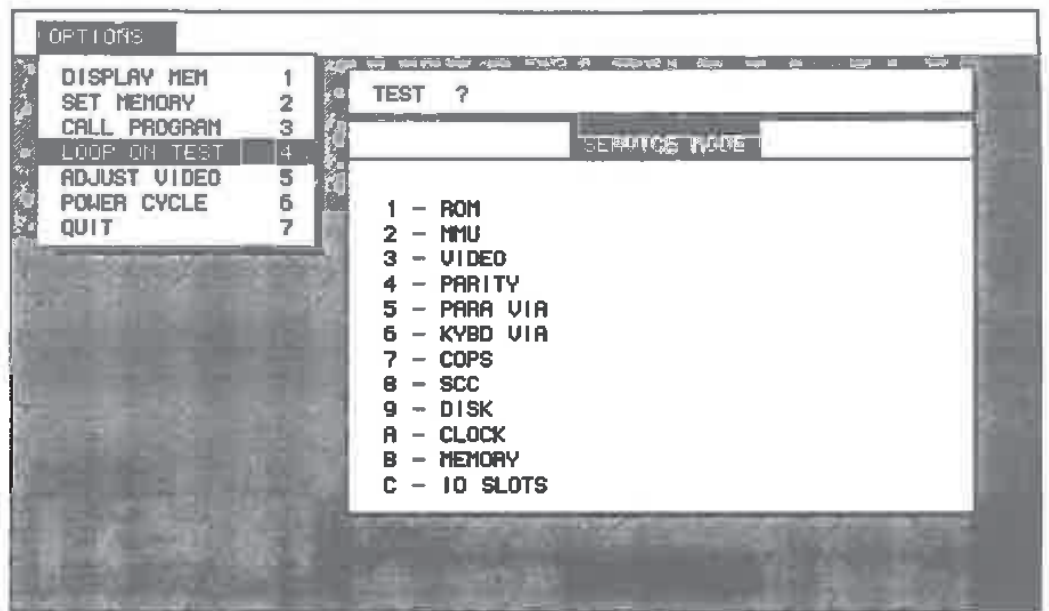

Figure 13-16 The Lisa's built-in service mode. Use with caution!

Warning! The Power Cycle & Loop On Tests presume a stock hardware configuration. They should not be used with a modified Lisa 2 or a Macintosh XL. Running the Power Cycle test with an 800K disk drive upgrade will cause the disk drive test to fail. Running the Power Cycle test on a Lisa 2/S with an internal hard drive upgrade could wipe out the boot blocks on the hard disk. On startup, you'll get a cross over the hard disk icon with error code 84. You'll still be able to boot from a floppy, and the hard disk will mount, but in order to boot from the hard drive again, you may have to remove it, and send it out for a low level format. Use with extreme caution!

Summary of the Diagnostics Routines

The Lisa's built-in diagnostic routines display various icons accompanied by error codes pointing to particular electronic components. In practice, electronic failures are seldom seen. The most common problems result from mechanical failures, especially with the disk drives. The next section tells how to deal with them.

Mechanical Problems with the 3.5-Inch Disk Drive

Just like its Macintosh counterpart, the Lisa's 400K 3.5-inch disk drive is subject to the following failures:

1. Eject mechanism makes eject noises but disks don't come out.
2. Eject mechanism fails to operate (doesn't make any eject noises at all) when rebooting after a System crash.
3. Grinding noises get louder and louder. Disks become unreadable.

The first failure indicates a lubrication problem. The second failure indicates the presence of an OEM 400K Mac drive. The third failure indicates a dirty stepper cam, a dirty head, and/or a clogged pressure pad.

Drive Makes Eject Noises but Disks Fail to Eject

When the drive makes eject noises but the disks don't come out it usually means that the grease on the eject mechanism has solidified. To fix it, all you have to do is disassemble the eject mechanism and change the grease. Here's the complete procedure:

1. Disconnect the computer's power cord from the wall outlet.
2. Remove the disk drive cage as shown in Figures 13-1 to 13-3.
3. Disconnect all data and power cables from the installed drives.
4. Remove the internal disk drive by tilting the drive cage forward and loosening four Phillips-head screws at the bottom. Use a #1 Phillips-head screwdriver. Support the drive with one hand as shown in Figure 13-17.
5. Use a small 1/8-inch slotted screwdriver to remove the C-ring shown in Figure 13-18.
6. Rotate the drive such that the disk opening is facing down and the eject motor is facing up. Use a small 1/8-inch slotted screwdriver to remove a single black flat-head screw behind the eject motor. Remove the top cover.
7. Rotate the drive such that the circuit board is facing up. As shown in Figure 13-19, use a small 1/8-inch slotted screwdriver to remove four gold-colored flat-head screws mounted *beneath* the circuit board.

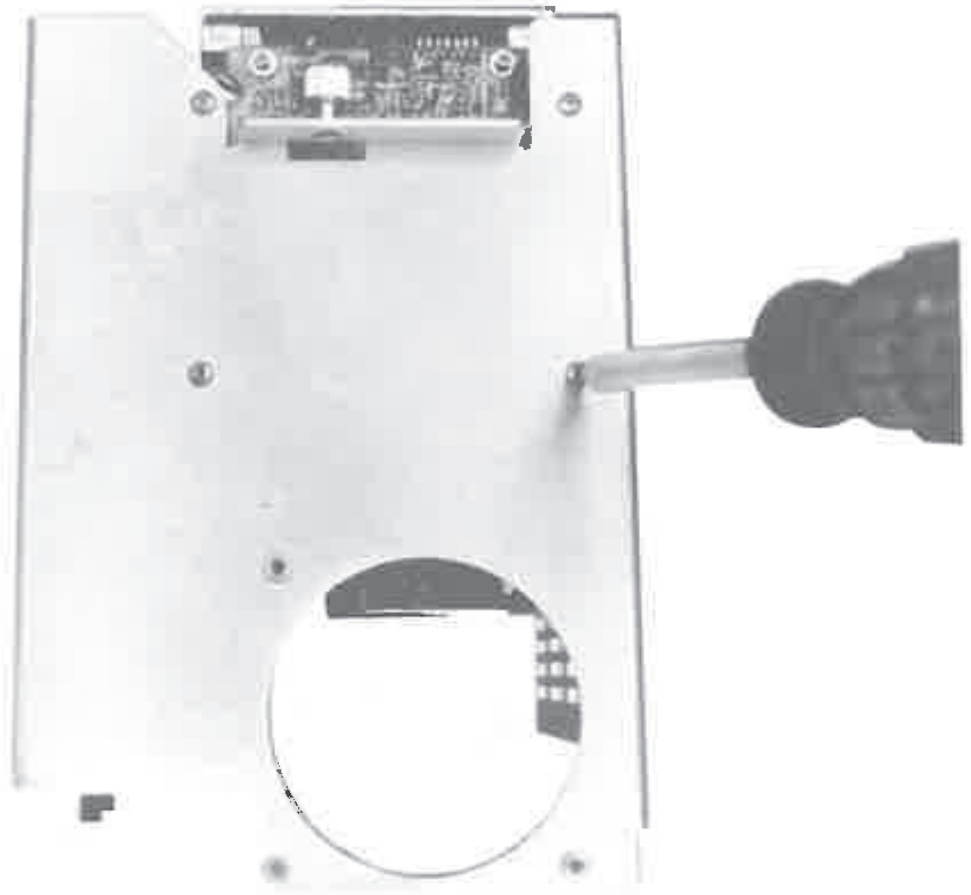

Figure 13-17 Lisa disk drive removal.

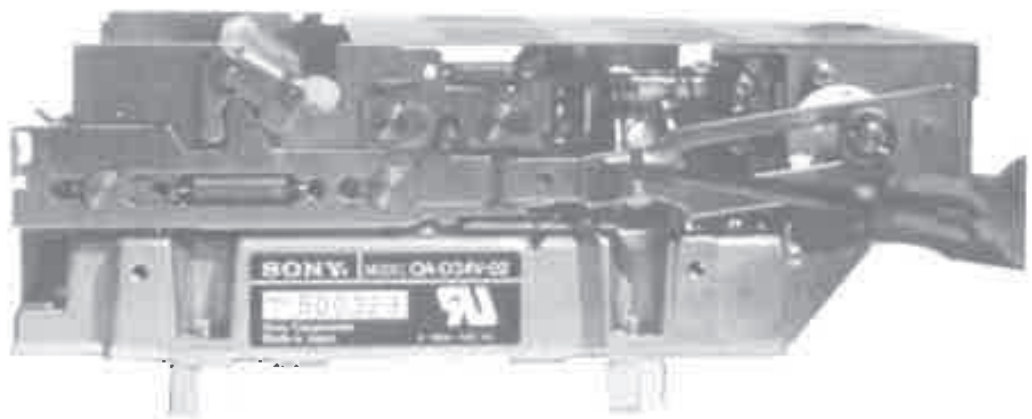

Figure 13-18 C-ring removal.

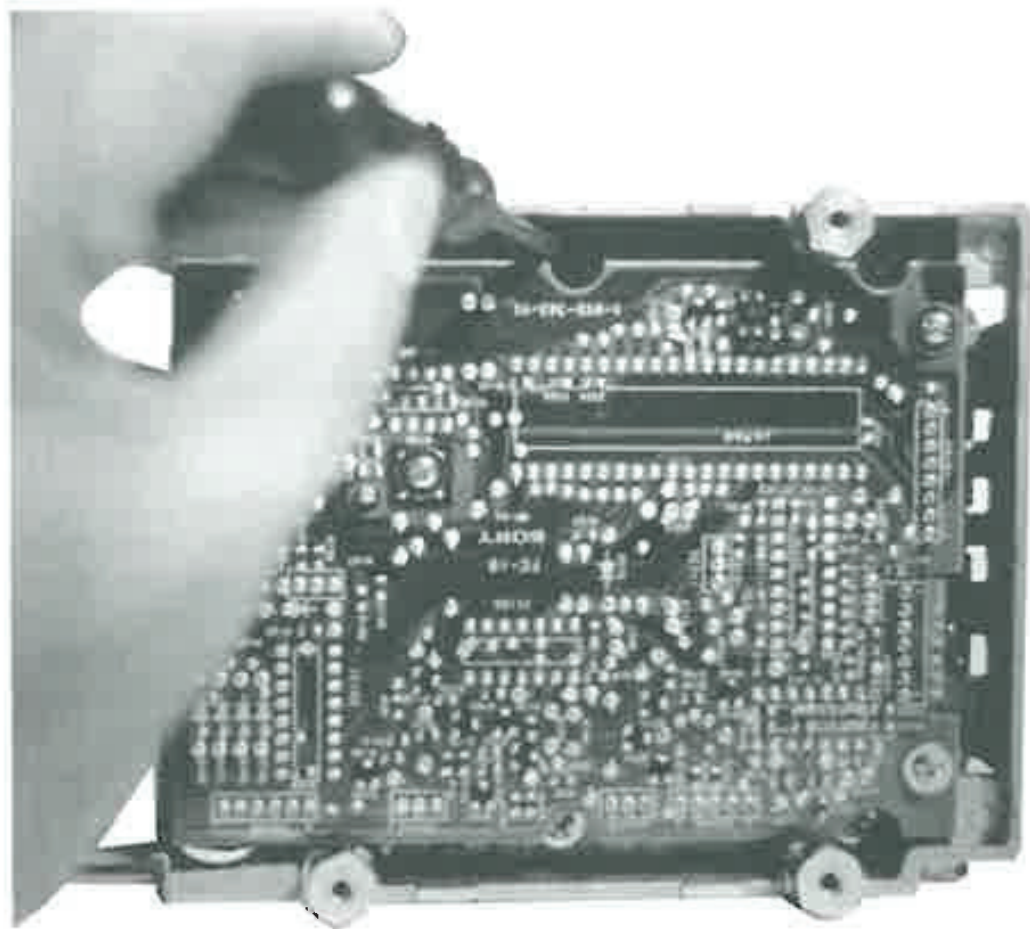

Figure 13-19 Carrier mechanism screw locations.

Note that three additional gold-colored screws on top of the circuit board do not have to be removed.

8. As shown in Figure 13-20, disengage the disk carrier mechanism from the chassis.
9. With clean paper towels, wipe up as much of the old sticky grease as you can. The more you wipe up now, the less you'll have to dissolve later.
10. Set up a disposable aluminum tray as shown in Figure 13-21. Hold the eject mechanism over the tray and spray the remaining grease away with WD-40.
11. Work the levers back and forth as shown in Figure 13-22. Thumbs are shown on the release points. Work these points back and forth and respray as necessary until all of the old grease is gone.

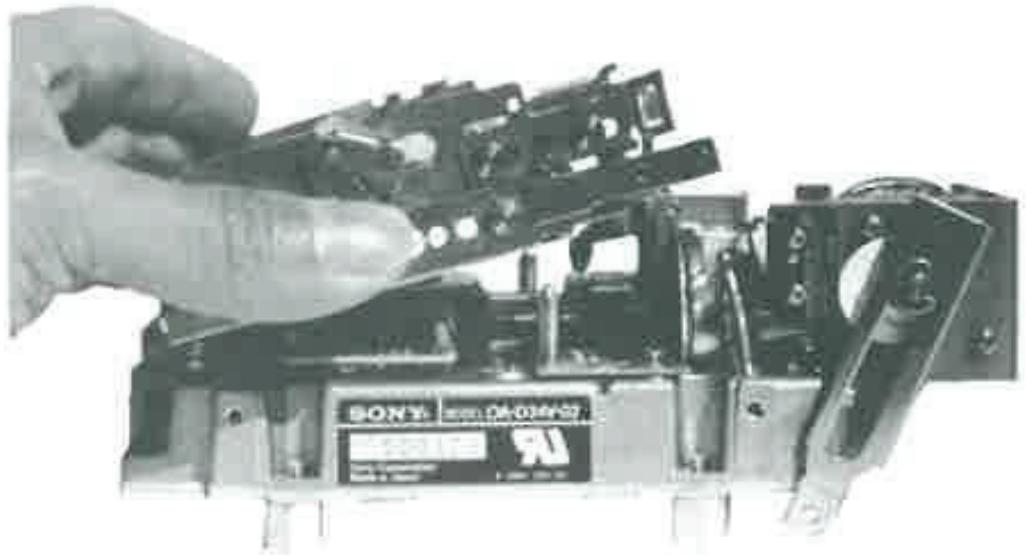

Figure 13-20 Carrier mechanism removal.



Figure 13-21 Spray away the old grease with WD-40.

12. WD-40 both removes the old grease and relubricates the drive. No additional lubrication is necessary. Reverse steps 8 through 1 to reassemble the repaired disk drive.

Relubricated carrier mechanisms work as good as new. Repairs last indefinitely because, unlike grease, WD-40 can't solidify.

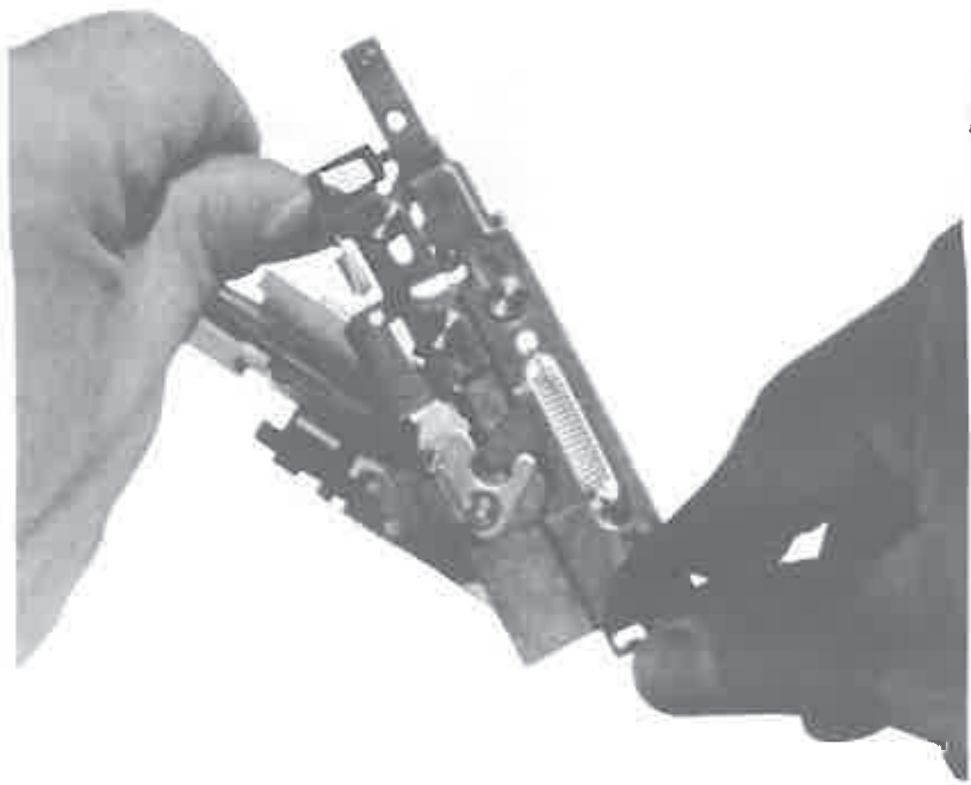

Figure 13-22 Work the sliders back and forth until all of the old grease is gone.

This same procedure works for 400K Macintosh disk drives as well. The lubrication principles also apply to 800K Mac drives. Unless you operate in a hermetically sealed environment, all auto-eject drives eventually develop problems with the carrier mechanism. Tiny eject motors don't have nearly the same strength as a human finger on a push button. Periodic relubrication is (or at least it should be) part of routine maintenance.

Drive Does Not Make Eject Noises and Disks Get Stuck

Occasional eject failures which are not accompanied by eject noises indicate that the OEM Lisa drive has been replaced with an OEM Mac drive. Despite the mechanical similarity between 400K drives (right down to the part numbers!), the OEM Lisa model has a different eject mechanism. It's always triggered on shutdown, whether there's a disk in the drive or not. The OEM Mac model is not triggered, unless there is a disk in the drive. Since the Lisa can't do a disk check after a System crash, Mac drives fail to eject them when you restart the computer. Inserted disks remain in the drive, and the Lisa's boot ROM doesn't know what to make of them. There are three possible fixes.

One is to drill a 1/16-inch hole to the right of the drive opening (just like small Macs) and use a straightened heavy-duty paper clip to eject the disks. The second is to repair and reinstall the original Lisa drive. The third is to install MacWorks Plus version 1.0.6 or later. Because MacWorks Plus includes 800K drive support, and since the only difference between a 800K Lisa drive and an 800K Mac drive is the mounting hardware, this problem was (and had to be) taken care of, or the 800K Lisa disk drive would malfunction exactly the same way. MacWorks Plus cures many long-standing Lisa problems. We'll be taking a very close look at it at the end of this chapter.

Grinding Noises

Grinding from the disk drive indicates a dirty stepper cam, a dirty head, and/or a clogged pressure pad. Clean the cam shaft with cotton swabs and WD-40, but don't loosen the cam retaining screw. Dirty heads should be cleaned the same as tape recorder heads. For easier access, pull back the pressure pad assembly as shown in Figure 13-23. Use a cotton swab moistened with tape head cleaner.

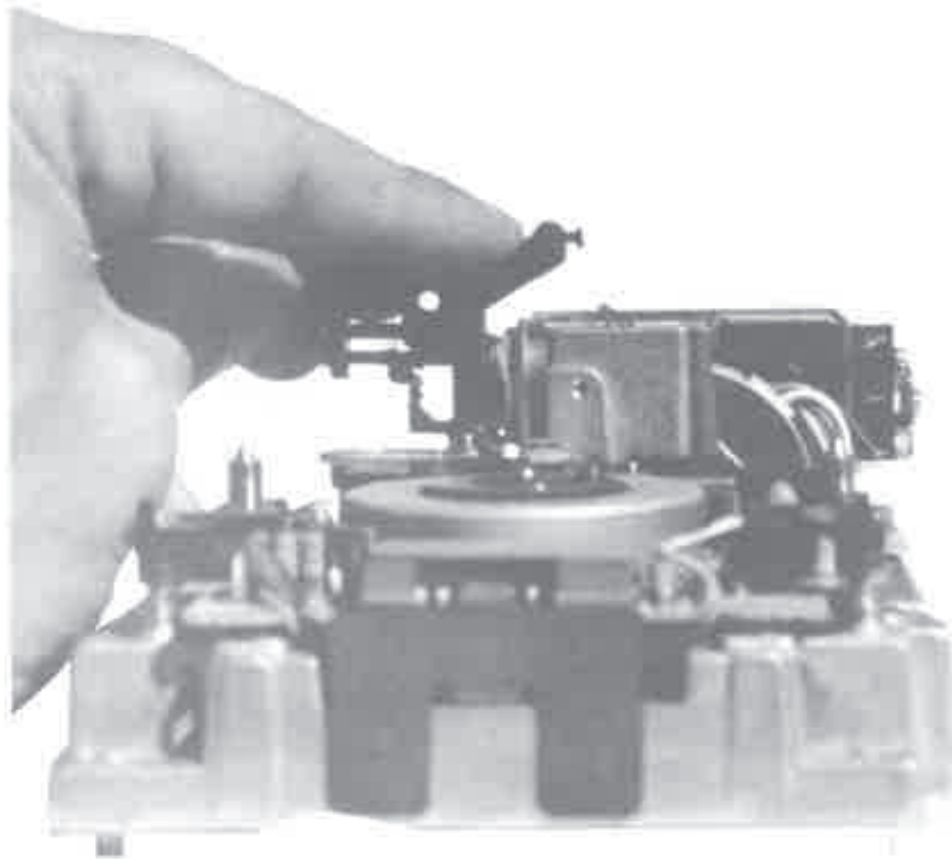

Figure 13-23 For easy access to the 400K drive head, pull back the pressure pad assembly.

The pressure pad is made of a cotton-like material. Brush it clean with a small lint brush. If none is available, flick the surface with your fingernail. Depending on the age and condition of the drive, be prepared for a surprising amount of disk dust! Cleaning fluids should be avoided; they tend to be absorbed.

Hard Drive Repairs

The Lisa's OEM parallel hard drives (external Profile drives and internal Widget drives) are subject to three common problems:

1. Startup error code 81—pertains to 10MB Widget drive.
2. Startup error code 84—pertains to all Lisa hard drives.
3. Sad Mac error code 0F0064—pertains to all Lisa hard drives formatted under MacWorks 3.0 or MacWorks XL.

Startup Error 81

Startup error code 81 pertains primarily to the Lisa 2/10 and the Macintosh XL. Both models have a 10MB internal hard drive equipped with an electric brake. On startup, immediately after completion of the module tests, the electric brake makes a distinct clunk. If there's no clunk, it means the brake froze (didn't release). If the brake freezes, the hard disk can't spin; the result is a cross over the internal drive icon with error code 81 as shown in Figure 13-24.

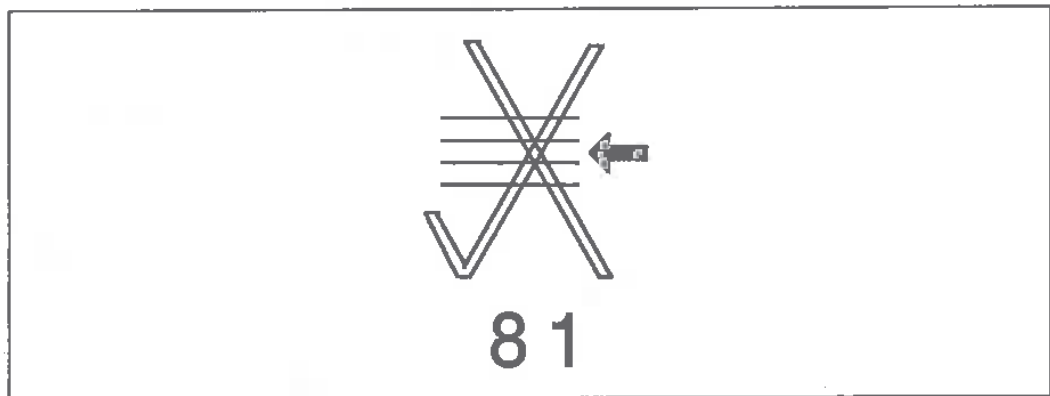

Figure 13-24 Error code 81 indicates a problem with the brake solenoid.

Without further information, many people assume that they need a whole new hard drive. Rather than spend the money, they shelve the computer. Well, it's time to dust them off! Error code 81 simply means the

brake is out of adjustment. You can fix it, easily, in under an hour, with a #1 Phillips-head screwdriver and a .012-inch feeler gauge. Here's the complete procedure:

1. Disconnect the computer's power cord from the wall outlet.
2. Remove the disk-drive cage as shown in Figures 13-1 to 13-3.
3. Disconnect all data and power cables from the installed drives.
4. Turn the cage upside down. This puts the relatively light disk drive on top and the relatively heavy hard drive on the bottom.
5. Use a #1 Phillips-head screwdriver to remove six screws (three on each side of the cage) which hold the hard drive in place.
6. Lift the drive cage straight up. This leaves the hard drive upside down on the table.
7. Use a #2 Phillips-head screwdriver to remove four screws from the sheet metal support bracket as shown in Figure 13-25. Lift the bracket away and put it aside.

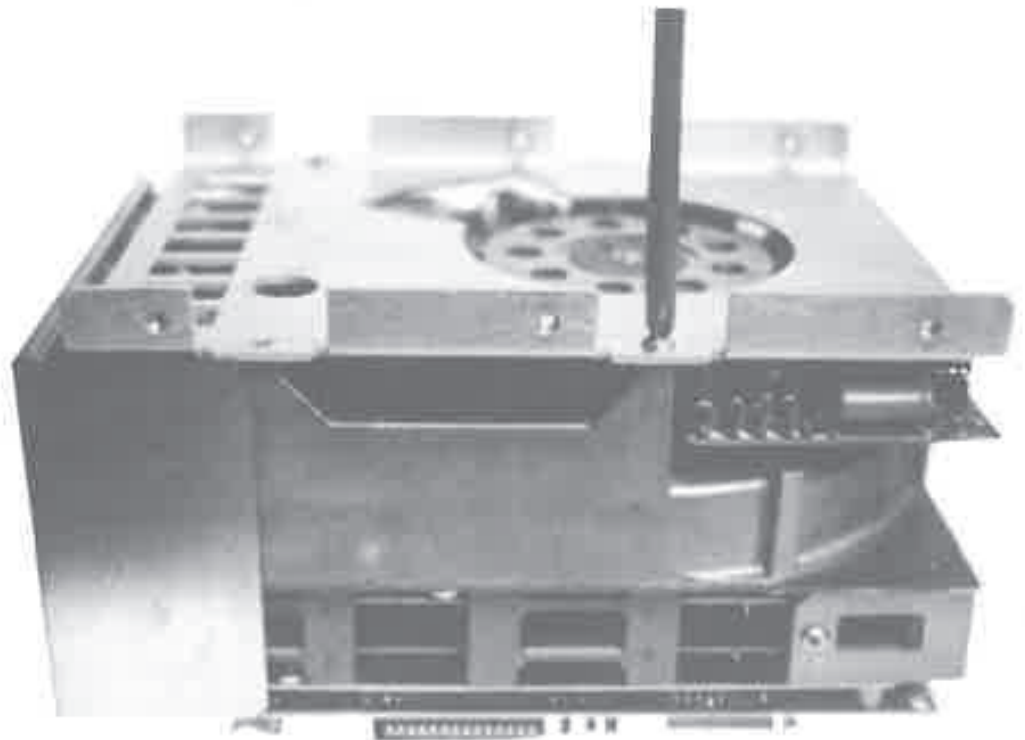

Figure 13-25 Four screws hold the sheet metal support bracket.

8. Locate the solenoid marked "Inertia Dynamics, Collinsville, CT USA." Insert a 0.012-inch feeler gauge as shown in Figure 13-26.

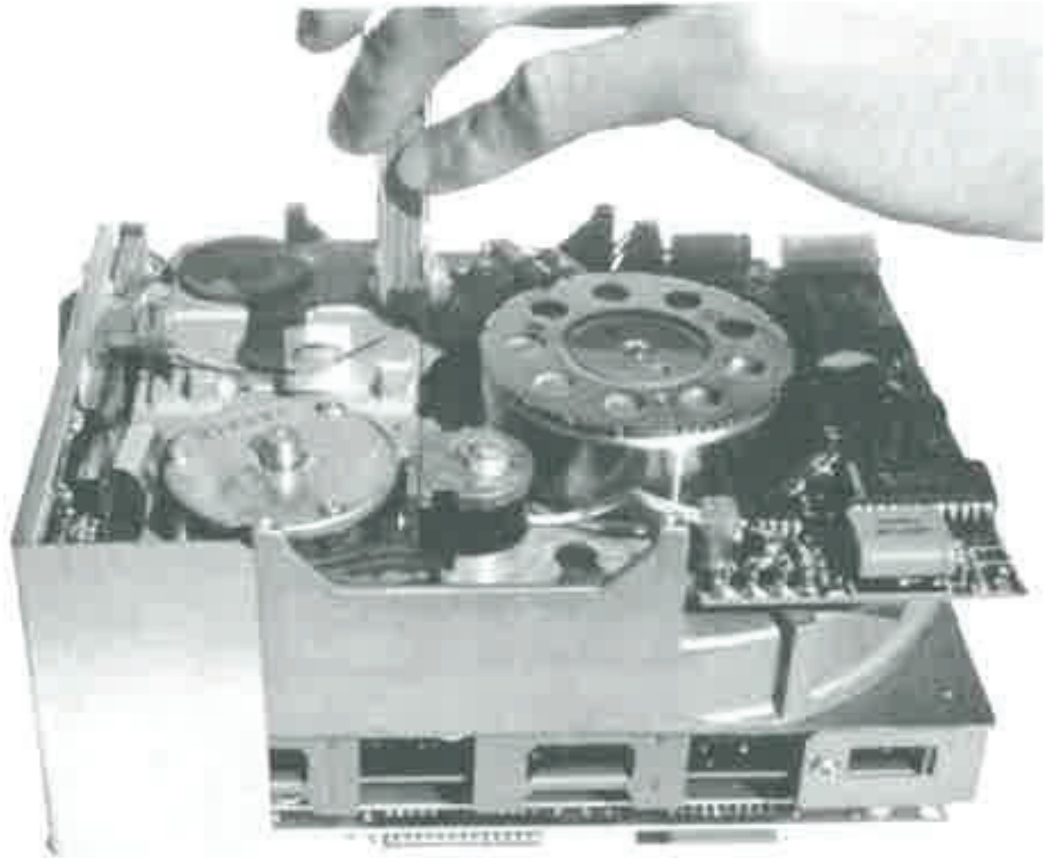

Figure 13-26 Adjust the brake with a 0.012-inch feeler gauge.

9. At the time of failure, clearance might be as much as 0.075 inch. Loosen the solenoid holding screw and adjust for 0.012-inch clearance.

Tighten the screw, reverse steps 7 through 1, and everything should be OK! If not, repeat steps 1 through 9, allowing a little more or a little less clearance, until you get the brake working again.

Startup Error 84

Startup error code 84 pertains to Profile and Widget drives. It means the boot blocks are damaged. There are three possible fixes.

Fix one involves double-reformatting the drive—first under Lisa OS, then under MacWorks XL. Double-reformatting the drive is time-consuming and it only applies to unmodified computers. You can't use this method with a Macintosh XL Screen Modification Kit unless you pull the 3A ROMs and reinstall the old ROMs. Also, double-reformatting doesn't *always* work. In fact, it's never worked for me! Still, other people I respect have been successful with this method so, for what it's worth, I'm mentioning it here.

Fix two involves reformatting the drive with MacWorks Plus version 1.0.14 or later. Holding down the Apple and the left Option keys while double clicking the MW_Install icon opens the program in the expert mode. Expert mode recognizes most unmountable drives and gives the option to you to reinitialize them. Afterwards, the drive may or not be bootable.

Fix three involves sending your drive to Sun Remarketing. Using a special machine, Sun technicians can do a low level format, which rewrites the boot blocks, then a high level format, which installs the latest version of whatever operating system you've been using (Lisa OS, MacWorks XL, or MacWorks Plus). This method always works and it's a lot less painful than having to buy a whole new drive.

Sad Mac Error Code 0F0064

Sad Mac error code 0F0064 pertains to any Lisa hard drive formatted under MacWorks 3.0 or MacWorks XL. At the time the original MacWorks was written, other Macs weren't equipped with hard drives. The old System software, written to 400K floppy disk specifications, has trouble dealing with big disk directories. If over 100 files accumulate, everything slows down and eventually fails. Error code 0F0064 generally indicates an irreparable problem with the System & Finder. There are three possible fixes. The first fix involves rebooting from the hard drive while holding down the Option key. If MacWorks itself is OK, you'll get a floppy disk icon with a blinking question mark. At that point, insert the MacWorks System disk. It'll load, you'll get the standard "Welcome to Macintosh" sign-on message, and, shortly thereafter, both disk icons (the floppy disk icon and the hard disk icon) should appear. Now all you have to do is replace the System files. To do that, open the System folder on the MacWorks System disk, select the System & Finder and drag them to the hard disk. A dialog box asking whether to "Replace items with the same names with the selected items?" will appear. Click OK and that's all there is to it.

The second fix applies when the hard drive icon doesn't appear. In that event, you need a special disk called Hard Disk Mount. Here's the complete repair procedure:

1. If the computer is on, reach around the back with your right hand and press the reset button. If the computer is off, turn it on.
2. Immediately after hearing the first click, tap any key but Caps Lock.
3. When the STARTUP FROM menu appears, insert the HD Mount disk and click the disk drive icon or hold down the Apple key and press the 2 key (the one on the keyboard, not the one on the keypad) to proceed.
4. When the HD Mount disk ejects, you'll see a floppy disk icon with a blinking question mark. "Hard Disk Mount" will be written under it.

From here on, the repair is the same as above. Insert the MacWorks System disk, and shortly thereafter, both the floppy disk icon and the hard disk icon will appear. Replace the System files and that's all there is to it.

Note: Hard Disk Mount is for repair purposes only. It's not an upgrade! Replacing regular MacWorks with Hard Disk Mount (using the Hard Disk Install utility) is not recommended.

The third fix is to replace MacWorksXL with MacWorks Plus. MacWorks Plus provides full 128K ROM emulation, including the HFS file system, support for hard drives, support for SCSI drives, and it lets you use later versions of the Macintosh System and Finder. Install MacWorks Plus and you'll never see error code 0F0064 again.

MacWorks Plus

MacWorks Plus was developed by Sun Remarketing in full cooperation with Apple Computer. It's an official upgrade, supplied on disk, either 400K or 800K (you have to specify which) so you can use it with both the old and the new style 3.5-inch disk drives. As of version 1.0.6, the hard disk installer program required a megabyte of standard RAM (two 512K cards). If you have a memory upgrade, the upgraded card has to be in slot 2, and a stock 512K card has to be inserted in slot 1, or the installer won't run. The important point is, you need 1Mb of memory and at least one 512K card to run the MacWorks Plus Installer program. So if you're planning to buy a memory upgrade, make sure you hang on to at least one of the original 512K cards!

What It Does

Other Macs contain two ROM (read only memory) chips packed with unique operating code. The Lisa doesn't. As soon as you turn on other Macs, portions of that code are read into RAM (random access memory). All Macintosh programs, including the System and Finder, rely on that code and presume it's going to be there. If it's not there, programs can't execute.

The MacWorks Plus Install program creates a file containing complete 128K ROM emulation on a read only portion of your hard drive. Immediately after the automatic startup tests, that code is read into RAM by the Lisa's boot ROM. From that point forward, the Lisa is, for all intents and purposes, a big-screen Macintosh Plus.

The initial installation of MacWorks Plus takes several hours. This summary will give you an idea of what's involved:

MacWorks Plus Hard Drive Installation

1. Since the installer program reformats (erases) the hard drive, an important preliminary step is to back up all important files. Skip old system files. MW+ 1.0.6 requires new Macintosh System software (System 4.2 or later), so backing up System files is needless. After the backup, shut down normally and wait for the power light to go out.
2. Once the power light is out, wait 15 seconds or so for the internal hard drive to wind down (if appropriate) and turn on the Lisa. At the first click, tap any key but Caps Lock. Tapping a key will engage the Startup From menu as soon as the startup tests are done.
3. When the Startup From menu appears, insert the MW+ Boot disk and press Apple 2 to proceed.
4. As MacWorks Plus loads, a horizontal bar indicates progress. At the end, there's a beep followed by an icon of a floppy disk with a blinking question mark.
5. Assuming you have an icon of a floppy disk with a blinking question mark on the screen, insert the MW+ 400K System disk.
6. Once the desktop appears, eject the 400K System disk by choosing Eject from the File menu or by pressing Apple Shift 1.
7. Insert the MW+ Installer disk and wait for the disk icon to appear. Open the disk icon (if necessary) and then double click the MW+ installer icon. Swap disks as necessary until the program loads.
8. Follow the on-screen instructions to install MacWorks Plus onto your hard disk.
9. Reinsert the MW+ System disk. Drag the supplied System Folder to your hard disk.
10. Choose Shutdown from the Special menu.
11. Reboot. After the self-test finishes, you should see the Loading... indicator, then a MacWorks Plus sign on message. Next you'll be in the Finder.
12. Restore the hard disk. Be sure not to restore old System Files! MacWorks Plus 1.0.6, HyperCard 1.1, and MultiFinder 1.0 all require at least System 4.2 and Finder 6.0. Later versions may require even newer System software. The correct version was transferred in step nine. It's already been installed.
13. Select the Chooser desk accessory from the DA menu. Select the correct printer and reset the printer port.
14. Select the Control Panel desk accessory to reset the time, mouse, and keyboard settings. Choose SunTrol to set contrast, screen dimming, and startup device.

Miscellaneous MacWorks Plus Information

Once installed, MacWorks Plus loads itself from the hard drive, then it usually boots the hard drive, but sometimes it shows you a floppy disk icon with a blinking question mark instead. When that happens, the Lisa is waiting for you to insert a Macintosh System/Finder disk. If you meant to start from the hard drive, press the right option key to proceed.

To reboot from a startup disk, hold down the Apple key and push the power switch. If you keep the Apple key down, you'll see the floppy disk icon with a blinking question mark. Insert a startup floppy disk, then let the Apple key up. The System file on the floppy disk (assuming it's version 4.2 or later) will now be in control of the computer. Once you get to the desktop, the floppy disk icon will be on top. The hard drive icon will be underneath.

Upgrading to MacWorks Plus may be all you need to do to bring an old Lisa/Mac XL up to the newest specifications. It's part of the 800K disk drive upgrade. It comes with internal hard drive upgrades, and it's available separately.

800K Disk Drive Upgrade

The 800K disk drive upgrade includes a new 800K disk drive, exactly the same drive that comes in every other Mac, a new disk drive ROM chip, the latest Macintosh System software, and the latest version of MacWorks Plus. All you need is a #1 Phillips-head screwdriver to install the drive and a small flat-head screwdriver to install the ROM. Figure 13-27 shows an 800K drive installed in a Lisa 2/5.

Here's the step by step 800K disk drive installation procedure:

1. Disconnect the computer's power cord from the wall outlet.
2. Remove the disk drive cage as shown in Figures 13-1 to 13-3.
3. Disconnect all data and power cables from the installed drives.
4. Remove the internal disk drive by tilting the drive cage forward and loosening four Phillips-head screws at the bottom. Use a #1 Phillips-head screwdriver. Support the drive with one hand as shown in Figure 13-17.
5. Swap drives. Support the new drive the same way. Screw it into the exact same holes.
6. Reconnect the data cables. Replace the drive cage. Reattach the front cover.
7. Remove the rear panel as shown in Figure 13-4.

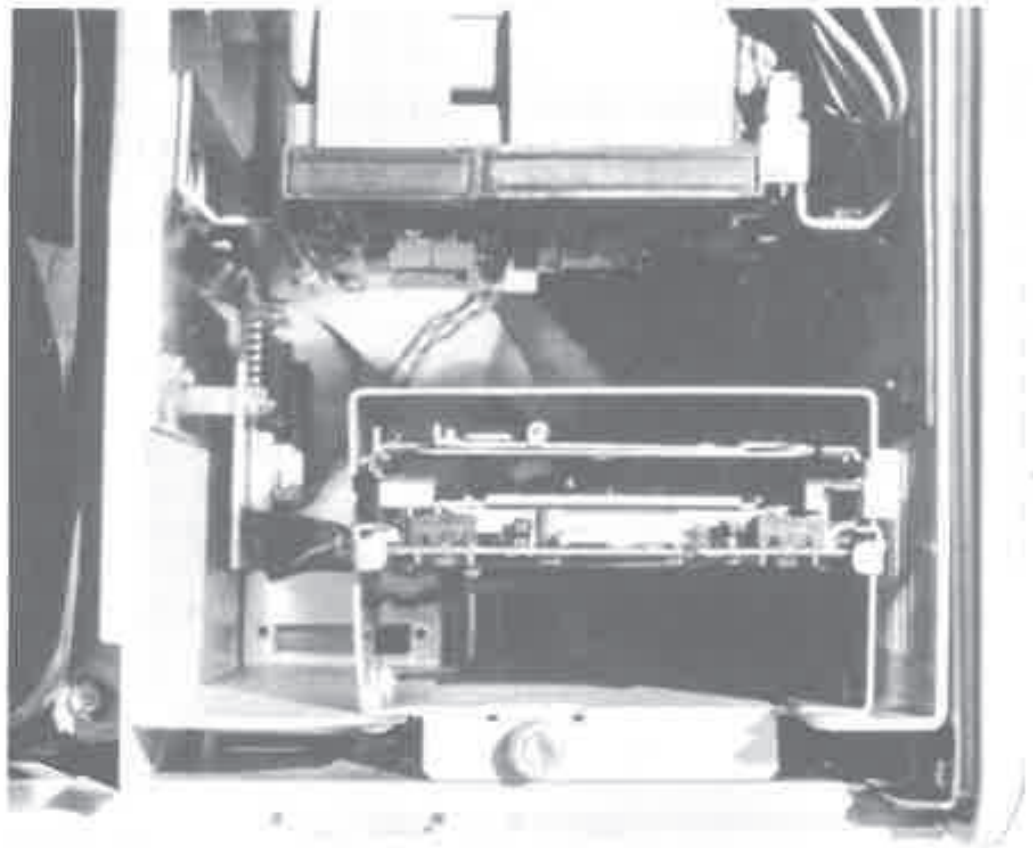

Figure 13-27 Apple-brand 800K disk drive shown here in a Lisa 2/5 is the same model used in every other Mac. 20Mb Miniscribe is the same OEM hard drive used in the Macintosh SE.

8. Refer to Figures 13-11 and 13-12. The disk drive controller circuit is on the upper left corner of the board. The disk drive ROM chips are marked with white stickers. On a Lisa, the ROM to pull is part# 341-0290 at position A1. On an XL, it's part# 341-0281D at position A2. Carefully pry both ends of the chip with a small flat-head screwdriver. Be sure to work from both ends. If you work from just one end, you'll bend and possibly break the pins.
 9. Orient the new chip so that the notch is pointing upward. Plug it into the socket. On a Lisa, the chip fits the socket perfectly. On a Macintosh XL, the socket is larger than the chip. Start from the bottom of the socket. The top of the socket is not used.
 10. Replace the rear cover, reattach the power cord, and that's it.
- Lisa 1's can also be fitted with an 800K disk drive upgrade. You'll need to replace the front cover; otherwise, the procedure is identical.

Internal Hard Drive Upgrades

Internal hard drive upgrades vary, but if you specify, you can buy the exact same OEM drives that come in a Macintosh SE. Here's the step by step internal hard drive installation procedure:

1. Disconnect the computer's power cord from the wall outlet.
2. Remove the disk-drive cage as shown in Figures 13-1 to 13-3.
3. Disconnect all data and power cables from the installed drives.
4. If there is an existing hard drive, turn the cage upside down. This puts the relatively light disk drive on top and the relatively heavy hard drive on the bottom. Use a #1 Phillips-head screwdriver to remove six screws (three on each side of the cage) which hold the hard drive in place. Support the drive as necessary. Lift the drive cage straight up. This leaves the hard drive in your hand or upside down on the table.
5. Swap drives. Support the new drive the same way. Screw it into the exact same holes.
6. Reconnect the cables. Replace the drive cage. Reattach the front cover.

Figure 13-27 shows a 20MB Miniscribe, the same OEM model that comes in a Macintosh SE, installed in a Lisa 2/5. Since there's no internal hard drive connector on a Lisa 2/5, the data cable is plugged into an external connector as shown in Figure 13-28.

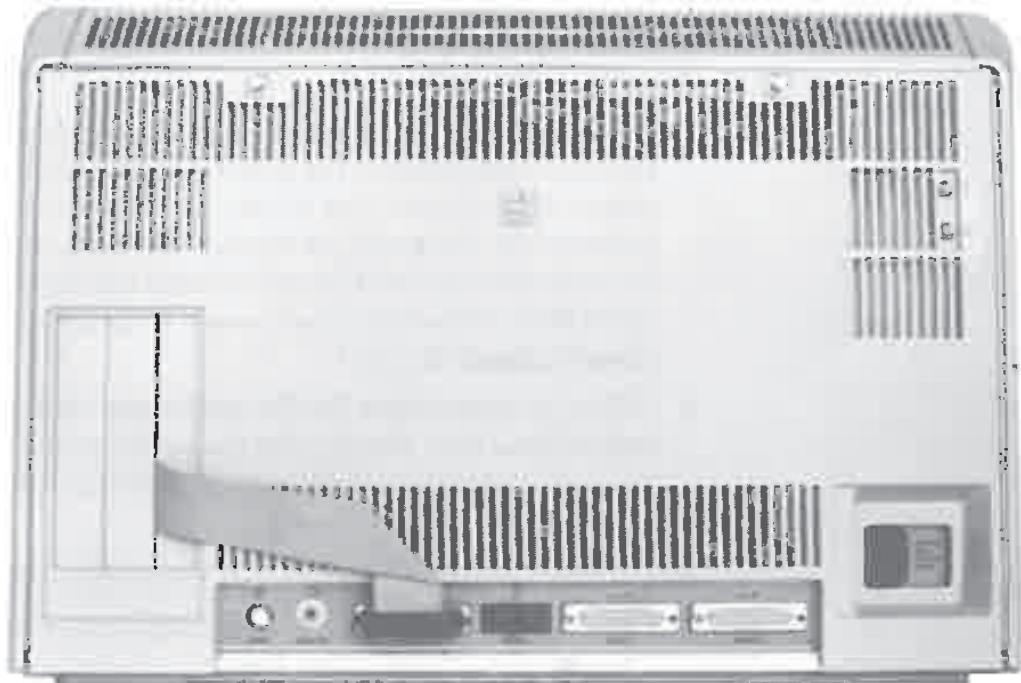

Figure 13-28 On the Lisa 2/5, internal hard drive upgrades plug into an external connector.

Noisy Hard Drives

Some hard drives tend to be intermittently noisy, like an annoyingly loud refrigerator. This problem isn't unique to Lisa/Mac XL internal hard drives, it occurs with other Mac hard drives as well. The fix is to remove the drive and check for a static discharge button. Intermittent strange noises often mean the discharge piece is too close to the media. Bend it back with a soldering aid as shown in Figure 13-29 and the noise will be gone. Be careful when you're doing this, but don't be overly concerned about bending it back too far. Some vendors advise removing the static button altogether. Generally, all you have to do is bend it back a little.

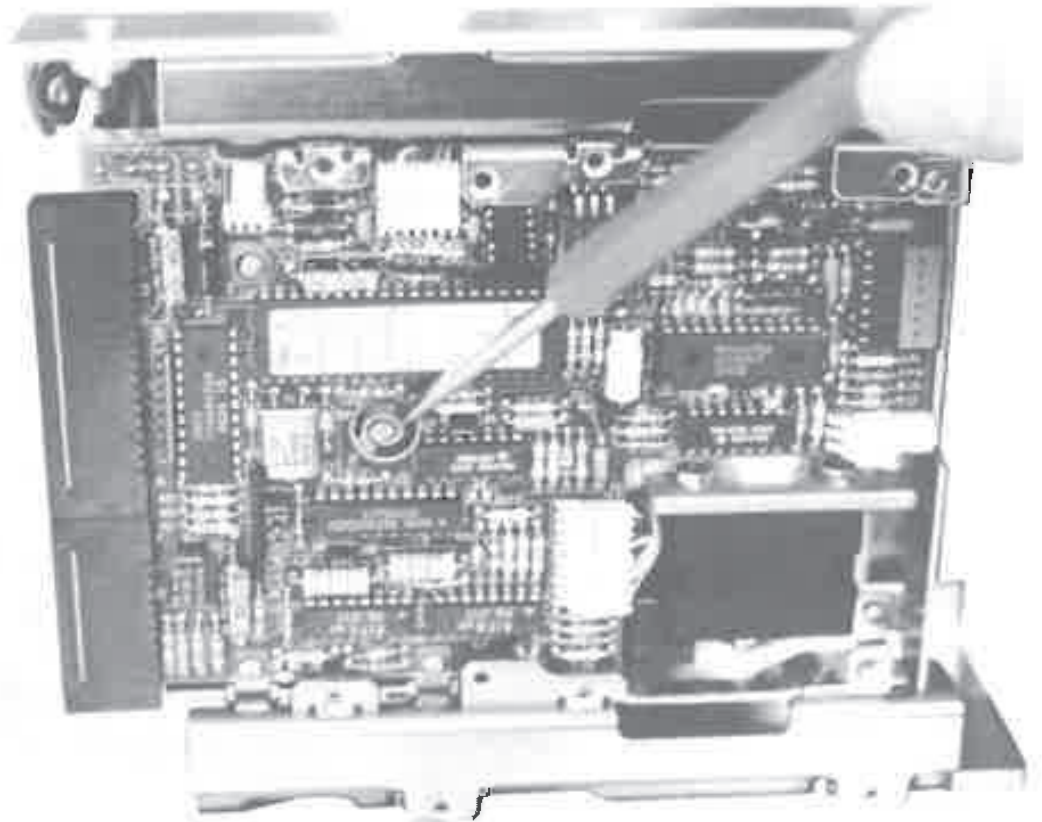

Figure 13-29 Intermittent strange noises often mean the discharge piece is too close to the media.

Expansion Card Upgrades

As shown in Figure 13-28, the Lisa has three PC-like expansion slots to the left of the rear panel. Recently developed expansion cards that simply plug into these slots include the multivoice sound processor (with audio output jack) shown in Figure 13-30 and the external SCSI port shown in Figure 13-31. Together with an 800K disk drive upgrade, these cards essentially turn any 1Mb Lisa/XL into a big-screen Macintosh Plus.

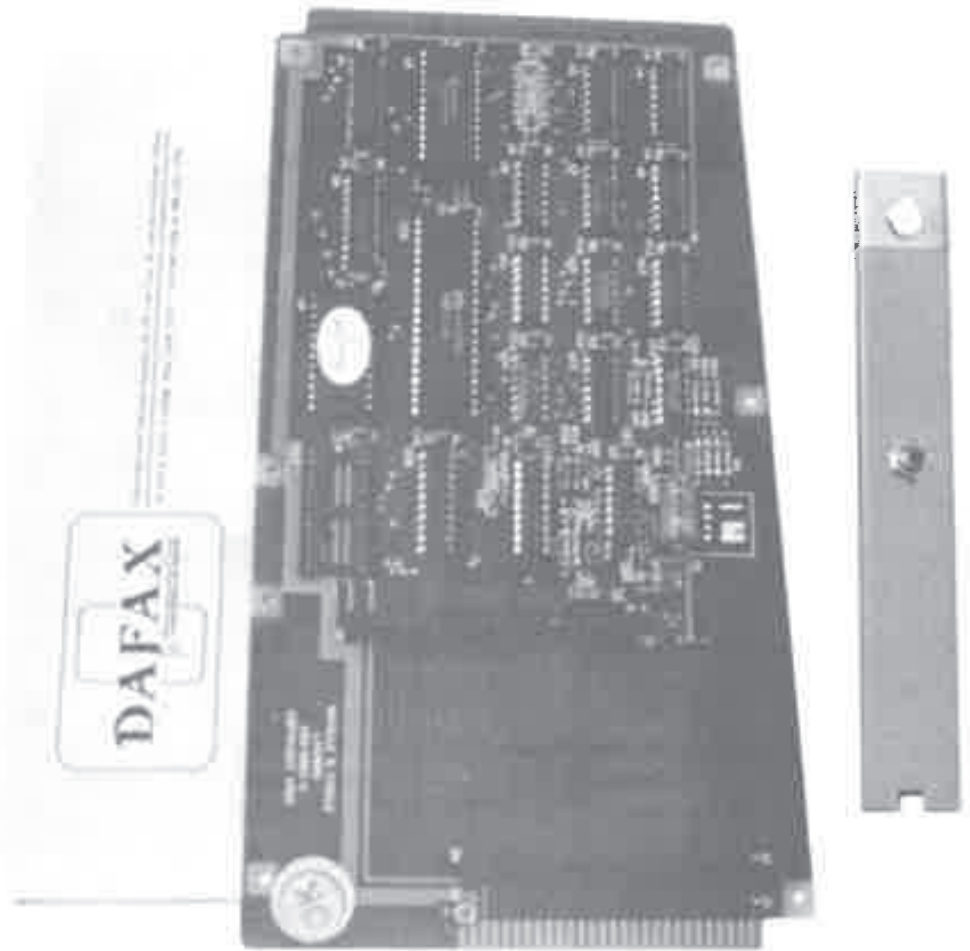

Figure 13-30 Multivoice sound card for the Lisa/Mac XL.



Figure 13-31 SCSI card for the Lisa/Mac XL.

Memory Upgrades

Early AST Ramstack upgrades (long since discontinued) took the Lisa/XL to 1.5Mb or 2.0Mb. RAM cards recently developed for the Lisa/XL use PC-style 256K \times 9 single inline memory modules (SIMMS). Upgrading beyond 2Mb requires CPU board modifications as well. Although the MC68000G8 processor can logically address 16 Mb, the original design of the Lisa/XL CPU board contains only enough physical address lines for 2Mb. By contrast, the 128K to 512K Mac CPU board contains just 0.5Mb of physical address lines, and the Mac Plus CPU board contains physical address lines for 4Mb. The necessary CPU board modifications add extra memory addresses, allowing you to populate the Lisa SIMM card all the way to 4Mb.

Video Upgrades—External Monitors

All Lisa/Mac XL computers are equipped with a composite video out connector. As shown in Figure 13-28, the video connector is a standard RCA jack located just to the right of the reset button, at the rear of the computer. This connector accepts ordinary RCA phono cables, defined as shielded 2-conductor wire with an RCA phono plug on each end. Unlike the Macintosh 128K to Macintosh II, it's not necessary to buy or build an add-on video card to use an external monitor on the Lisa/Mac XL. All you need is an external monitor with *autosynchronous multiscanning capability* and a matching *composite video in* connector.

One inexpensive multiscanning monitor that works very well on the Lisa/Mac XL (and just about every other computer, including Apple II's, Mac SE's, Mac II's, and PC compatibles) is the Princeton Max 15. Since the Max 15 is an autosynchronous multiscanning monitor with both composite video and TTL connectors, all you have to do to use it on a Lisa/Mac XL is plug it in via the composite video connector. By comparison, inexpensive TTL monitors designed for PC compatible computers don't work at all on the Lisa/XL; nor do NTSC compatible composite monitors designed for Apple II's and Apple III's.

Video Upgrades—Internal Monitor—Macintosh XL Screen Kit

No recently restored Lisa/Mac XL is complete without a Macintosh XL Screen Kit. Unlike the standard 9-inch Macintosh which has square pixels, the stock Lisa/XL has rectangular pixels. With rectangular pixels, circles look like footballs, squares look like spaghetti boxes. The purpose of the Macintosh XL Screen Kit is to square up the pixels. Proportions become exactly the same as on other Macs (1 to 1), but the overall display area (608 pixels \times 432 pixels) is made roughly the same as a 12-inch Macintosh II WYSIWYG monitor (640 \times 480). Standard 9-inch Macs only display 512 \times 342 pixels.

The complete screen modification kit includes new 3A boot ROMs, a new video ROM, a new yoke transformer, MacPaint 1.5, Macintosh System Software Update 2.0 and MacWorks XL version 3.0, just about everything you need to run early Macintosh software on a Lisa. (Newer software requires System Update 5.0 and MacWorks Plus as well.) Conscientious installation of the complete screen kit requires one to two hours. This summary will give you an idea of everything that's involved:

1. If the set is on, power down normally and switch off the power.
2. Physically disconnect the power cord from the wall outlet. If you're the least bit hesitant about discharging the CRT, leave the set disconnected overnight. By the next morning, most, if not all, of the high-voltage charge will have dissipated.

3. Disconnect all peripheral cables, and remove the rear cover from the back of the computer. Refer to Figure 11-4.
4. Remove the card cage and the CPU board. Refer to Figures 13-9 to 13-10.
5. Remove the existing 20-pin video ROM from location C6 on the CPU board. Replace it with part number 341-0348.
6. Remove the 28-pin boot ROM from location D12 on the CPU board. Replace it with part number 341-0347.
7. Remove the boot ROM from location D14. Replace it with part number 342-0346.
8. Replace the CPU board and put the card cage aside. Don't reinstall it just yet.
9. Remove the top cover. Refer to Figure 13-13.
10. Remove all rings, watches, and jewelry. Put on safety goggles.
11. With one hand behind your back, discharge the CRT through a 10-meg resistor as suggested in Figures 1-13 to 1-15.
12. Unplug the green and yellow CRT (yoke) to P2 cable from the video board. As illustrated in Figure 13-32, P2 is located approximately halfway down the left side of the board.

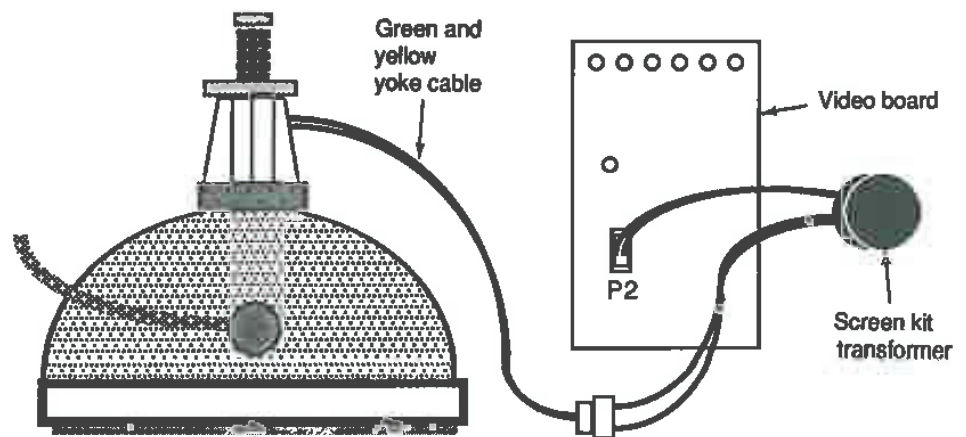

Figure 13-32 XL screen kit wiring details.

13. Plug the yoke cable into the new screen kit transformer. Plug the new transformer into P2.
14. The new transformer attaches to the outer wall of the disk-drive chamber with double-sided tape. Clean the area, and attach the transformer as shown in Figure 13-33.



Figure 13-33 The new transformer attaches to the outer wall of the disk-drive chamber with double-sided tape.

15. Locate the six adjustment potentiometers labeled "CONT.," "HOR. PHASE," "HEIGHT," "V. HOLD," "WIDTH," and "V. LIN" which are at the top of the video board. As shown in Figure 13-34, these adjustments have been sealed at the factory and will have to be unsealed and readjusted for use with the screen kit.
16. With a sharp razor knife, carefully remove all of the sealant. The key word here is *all*. It's not enough just to break the sealant. Any glob that remains may artificially limit the adjustment, making it impossible to properly realign the screen. For best results, every glob of sealant must be removed!
17. Refer to Figure 13-9. Slide the card cage back into the Lisa, and reconnect the power cord. Turn on the Lisa/XL.
18. Adjust an accurate VOM meter to the lowest DC volt scale capable of measuring 5.0 V DC. Attach the black probe to the Lisa chassis. Locate the HOR. PHASE potentiometer, labeled R34, which is second from the left as you face the front of the video board. Turn around and face the rear of the video board. Find the point where R34 is soldered to the printed circuit. Insulate the red VOM probe with a piece of shrink tubing. Carefully touch the tip of the insulated, red probe to the rightmost of the potentiometer's three solder joints. (Note: if you do this while leaning over the front of the computer, the 5.0-V joint will be on your left.) Be careful not to short uninsulated probe tips to the steel card

cage. Observe the meter. It should read 4.95 to 5.0 volts. If the reading is out of range, go on to step 19. If it's in range, skip to step 21.

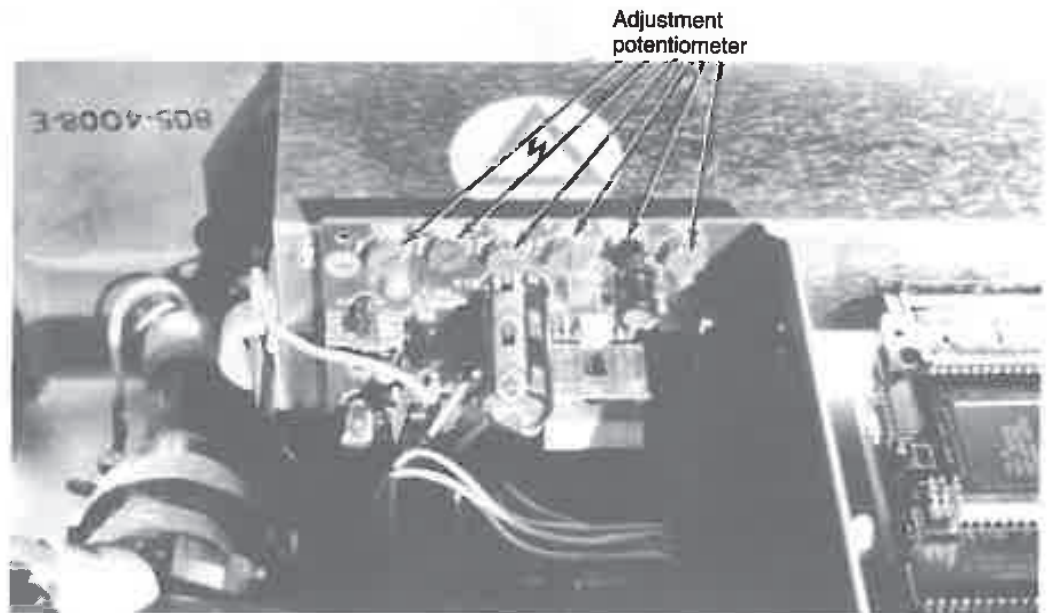

Figure 13-34 The CONT., HOR. PHASE, HEIGHT, V. HOLD, WIDTH, and V. LIN adjustments are at the top of the video board.

19. Refer to Figure 13-5. Turn off the Lisa/XL. Face the rear of the computer and unplug the power cord from the power supply. Unscrew the knurled knob and remove the supply by pulling straight back. New units may offer some resistance. Pull straight back.
20. As shown in Figure 13-35, find the access hole on the left side of the power supply. With a long-handled $\frac{1}{8}$ -inch slotted screwdriver, tweak the +5.00-V adjustment pot (R11) clockwise $\frac{1}{16}$ of a turn. Reinsert the supply and measure again (repeating step 18). If the meter still doesn't read +5.00 volts, repeat steps 18 through 20 until it does.
21. The Macintosh XL Screen Kit generally causes horizontal foldover which manifests itself as an annoying $\frac{1}{8}$ -inch to $\frac{1}{4}$ -inch white bar at the left edge of the screen. Turn the horizontal phasing control (at the top of the video board) counterclockwise until it's gone. Properly adjusted, the pointer on the HOR. PHASE pot will typically indicate eleven o'clock. If you can't adjust the HOR. PHASE pointer past twelve o'clock, check for excess sealant and remove it as noted in step 16. If the pointer turns fully counterclockwise and you still have a foldover problem, check the +5.00 voltage adjustment as noted in steps 18-20.

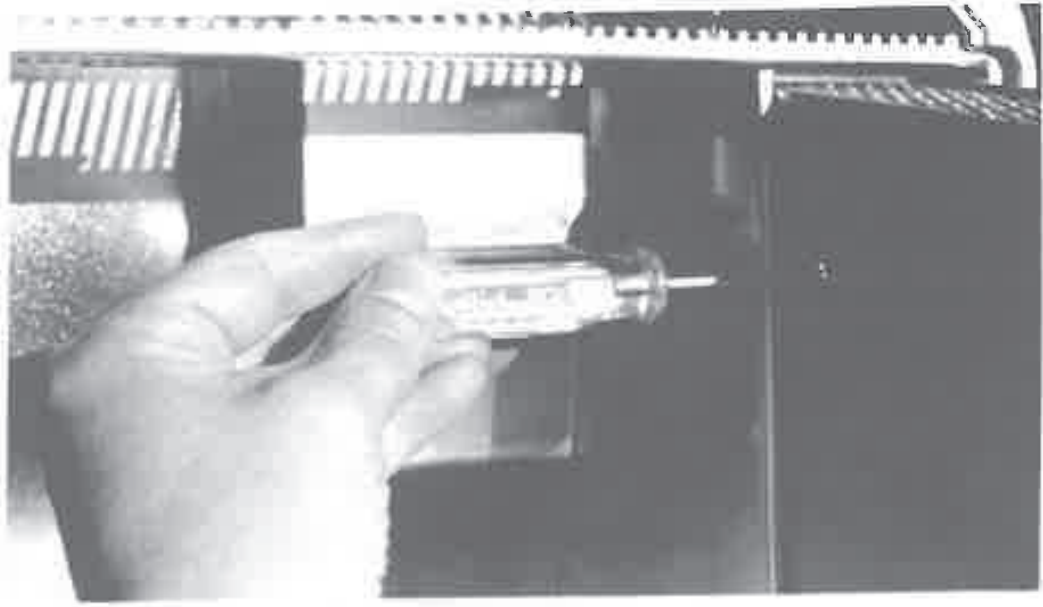

Figure 13-35 The +5.00-V adjustment can be reached through this access hole on the left side of the power supply.

The next step requires accuracy and involves the use of a soft cloth ruler (also known as a dressmaker's ruler). Use a good one. Because the edge protectors on cheap rulers are only haphazardly cemented to the tape, the first and last inches could be off by as much as $\frac{1}{8}$ inch! Attempting the final alignment procedure with an inaccurate ruler will prove futile. Choose a quality cloth ruler. Check it carefully for accuracy before proceeding.

22. Boot MacWorks or MacWorks Plus, and run 512K-TPG. Select 12-inch XL Screen Kit from the Screen Sizes menu, then choose Crosshatch from the Test Patterns menu. Hold a soft cloth ruler up against the screen. Measure the grid blocks. Typically, you'll find that the first few grid blocks will measure somewhat less than 1 inch and the last few grid blocks will measure substantially more than 1 inch. Adjust the HEIGHT and WIDTH controls on the video board until the grid blocks become squares, measuring exactly 1 inch \times 1 inch. Don't be surprised if you have to turn both controls fully counterclockwise (to approximately 8 o'clock). The final raster should measure exactly 8.44 inches in width

and 5.99 inches in height. If it's substantially larger than that, shut down the Lisa/XL and remove the power cord. Pull the card cage, observe the metal chassis and find the L3 (coarse width) access hole. As shown in Figure 13-36, L3 is located below the alignment pots and has to be tuned from the back side of the board. Insert a plastic hexagonal alignment tool through the access hole and turn L3 counterclockwise (in), one full turn. That should do it. Reinstall the card cage, reboot, and repeat the HEIGHT and WIDTH adjustments for best linearity.

23. Hold down the left Option key and select Balance Test from the Test Patterns menu. Stand back and evaluate the screen. The five test patterns should be nice and round, not egg-shaped. The grid blocks should be square, not rectangular. The display should also be square to the frame, not tilted. If the screen displays any of these problems, go to step 24. If not, skip to step 28.
24. If the raster is intolerably off-center or tilted, shut down the Lisa/XL and remove the power cord. Remove jewelry, put on goggles, etc., and discharge the picture tube again.
25. Refer to Figure 3-12. Remove the sealant from the purity rings at the neck of the CRT until both rings move freely.
26. Refer to Figure 9-2. In the event the raster was also tilted, loosen the yoke retainer as well.
27. Plug in the Lisa and, while exercising all precautions, adjust the purity rings using just one hand, until the raster is centered on the screen. Next, adjust the yoke, if necessary, until the raster is square to the screen. With one hand still behind your back, carefully snug the yoke.
28. Complete the installation by relocking the adjustments to the PC board with fresh sealant.
29. Replace the top and the back cover. You now have a big-screen WYSIWYG Macintosh display.

One final note, as mentioned earlier in this chapter, when the XL Screen Kit is used with the Lisa's light duty 1.2-A power supply (Apple Part# 620-6103), audible transformer ringing may result, horizontal retrace lines may become noticeable, and a slight screen flicker may be introduced. The fix is to install the Lisa's heavy-duty 1.8-A power supply (Apple Part# 699-0189).

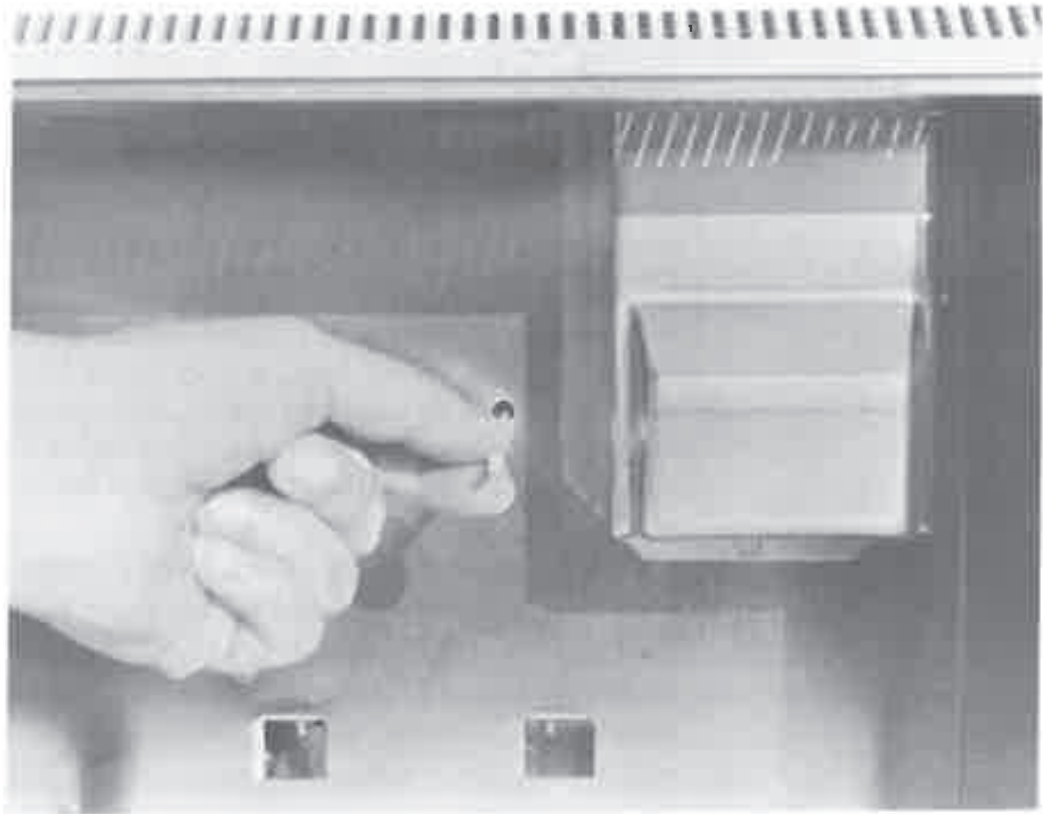

Figure 13-36 L3, the coarse width control, is located below the alignment pots and has to be tuned from the back side of the board.

Summary

Despite the implication, an XL Screen Kit is not something you buy to turn a Lisa into a Mac XL. It's something you buy to turn Lisas and Mac XL's into WYSIWYG big-screen Macintoshes. Combined with an 800K disk drive upgrade, the result is a big-screen 1024K Macintosh. Combined with SCSI and multivoice sound cards, the result is a big-screen Macintosh Plus. Combined with an internal hard drive, the result is a big-screen Macintosh SE. Add on an accelerator card, and what you've got is somewhere between a Macintosh SE and the Macintosh II.

Consider the similarities: All three computers have detachable, dual voltage, heavy-duty power supplies. All three computers accept internal hard drives. All three have built-in expansion slots. All three have internal boxer fans. All three have heavy-duty keyboards with integral numerical keypads. The Macintosh II is regularly matched to a 12-inch monochrome display. The Lisa/Mac XL is permanently matched to a 12-inch monochrome display. You could almost say that the philosophy has come full circle. We'll see how far it's come around when we look at the Macintosh SE in Chapter 14.

CHAPTER



Macintosh SE Repair Secrets

Some people are under the impression that the Macintosh System Enhanced (SE) is just an overpriced Macintosh Plus. Nothing could be further from the truth. The SE is a completely redesigned computer. At the same time, there are enough similarities to the older models, that much of the information in Chapters 1–12 still applies. SE-specific exceptions are described here.

The first part of this chapter recapitulates each of the earlier chapters, section by section. For the complete Macintosh SE repair procedure, read the original chapter first, then read the matching paragraph heading below.

The second part of this chapter documents unique Macintosh SE features. It looks at the expansion slot, shows what to look for in expansion cards, details the installation of internal hard drives, and shows how to mount an existing internal hard drive into an external case for greater reliability.

Tools and Techniques—SE-Specific Supplement to Chapter 1

The Macintosh SE is held together by only four T-15 screws (not 5). As shown in Figure 14-1, there is no Mac Plus-style battery compartment and no hidden fifth screw.

The SE's aluminum-colored RFI (radio frequency interference) shield (part# 805 5060 REV E) is fully insulated and much larger, similar to the Mac Plus RFI shield. The SE does not have a grounding spider.

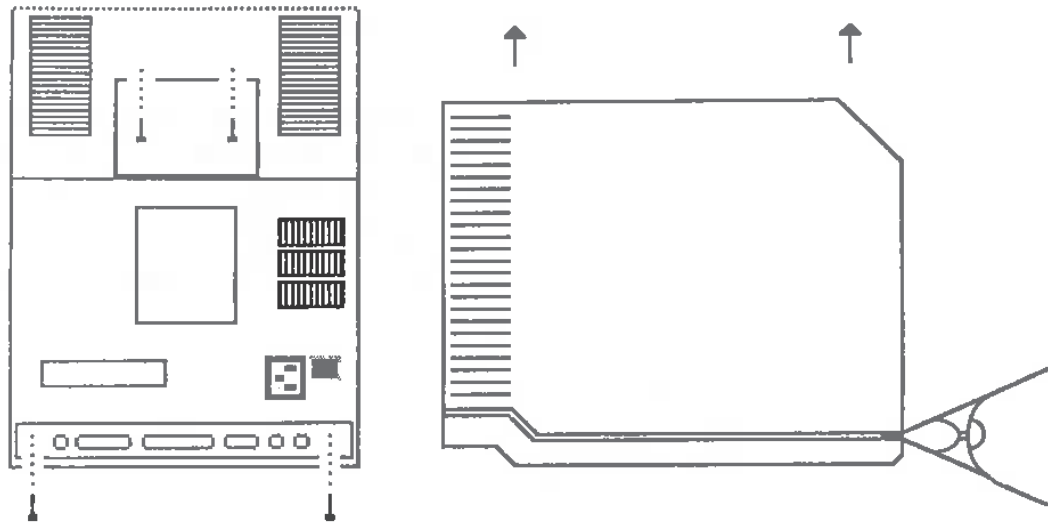

Figure 14-1 The Macintosh SE is held together by four T-15 screws.

The analog board is connected to the chassis by four #1 Phillips-head sheet-metal screws (not 3). Two screws are located at the lower left corner of the board. One screw is located 3 inches up from the lower right corner of the board. The fourth and final screw is 1 3/4-inches up from the lower right corner. This fourth location is also provided on the 128K to Macintosh Plus chassis, but the treads are not tapped and the extra screw is generally not used. See figure 14-2.

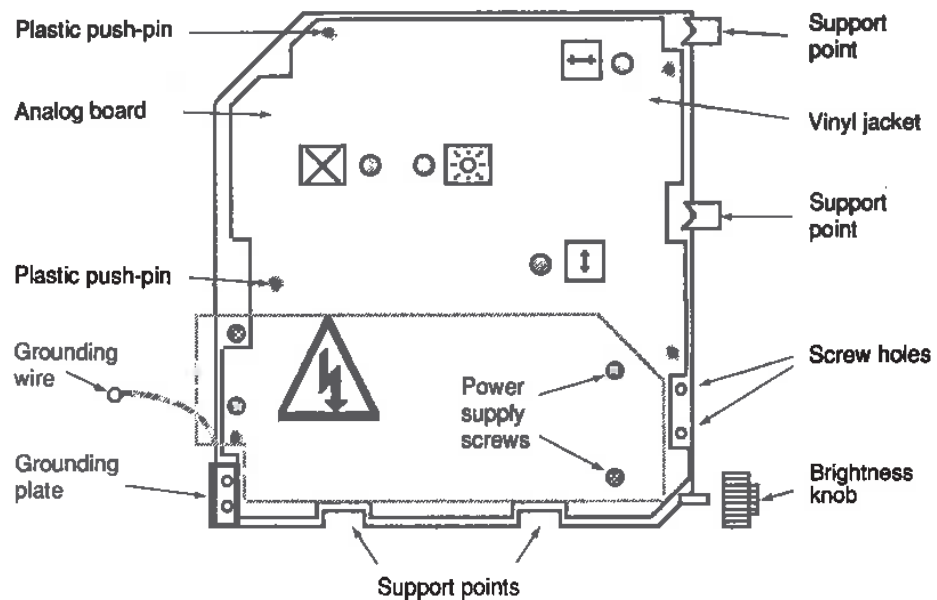

Figure 14-2 Mac SE— analog board mounting details.

As shown in Figure 14-3, the power supply is not part of the analog board! Instead, it's in a detachable metal case like the Lisa/Mac XL power supply.

The power supply's metal case is mounted to the analog board by four #1 Phillips-head machine screws. The power supply is electrically connected by plugging a short wiring harness into the analog board at reference P3.

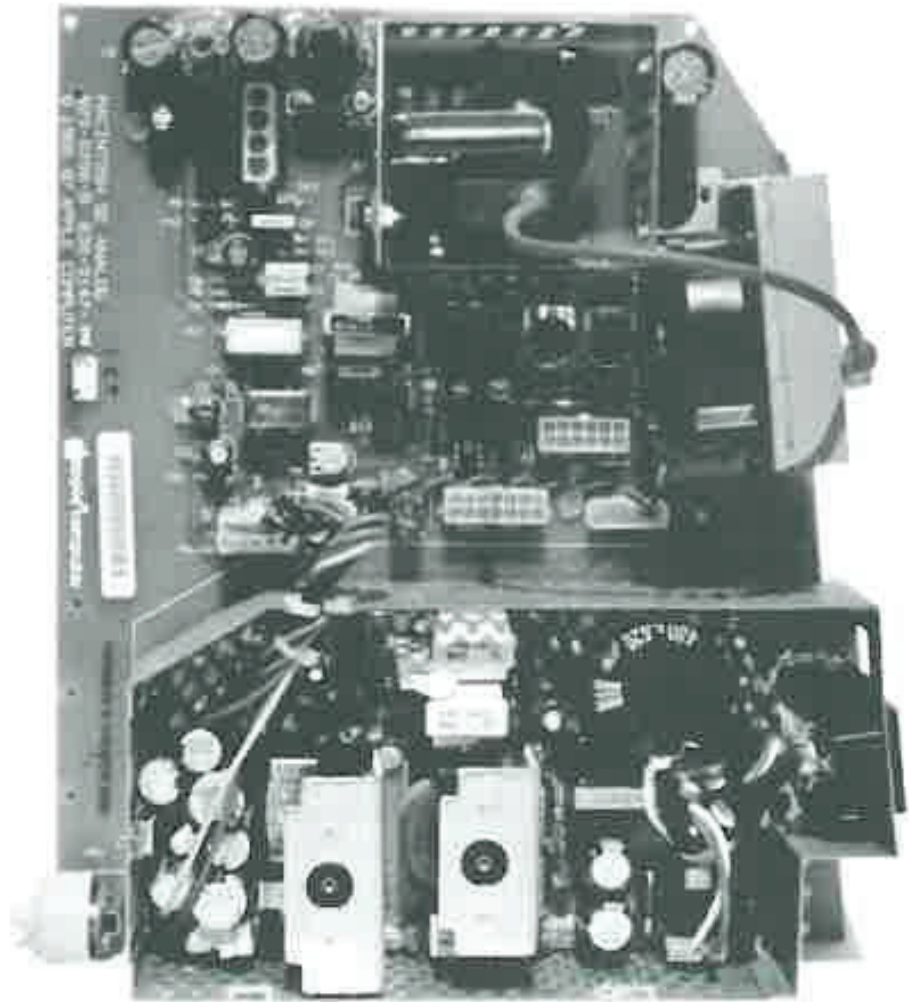

Figure 14-3 The Macintosh SE power supply (shown with the cover removed for clarity) is in a detachable metal case like the Lisa/Mac XL power supply.

As seen in Figure 14-3, a new high-voltage cage surrounds the flyback transformer. The transformer itself is the latest bleeder-resistor type. The function of the bleeder-resistor is to automatically discharge the picture tube on power down. Always discharge it again anyway, through a 10-meg resistor, just to be safe.

Preliminary Checks—SE Specific Supplement to Chapter 2

The preliminary check-up procedure for the Macintosh SE is exactly the same check-up procedure for other 9-inch Macs, but since the SE uses an Apple Desktop Bus-Mouse (described later on in this chapter) the voltage checking adapter is different. Instead of connecting to the mouse port, the SE's external voltage checking adapter connects to the external disk drive port as shown in Figure 14-4.

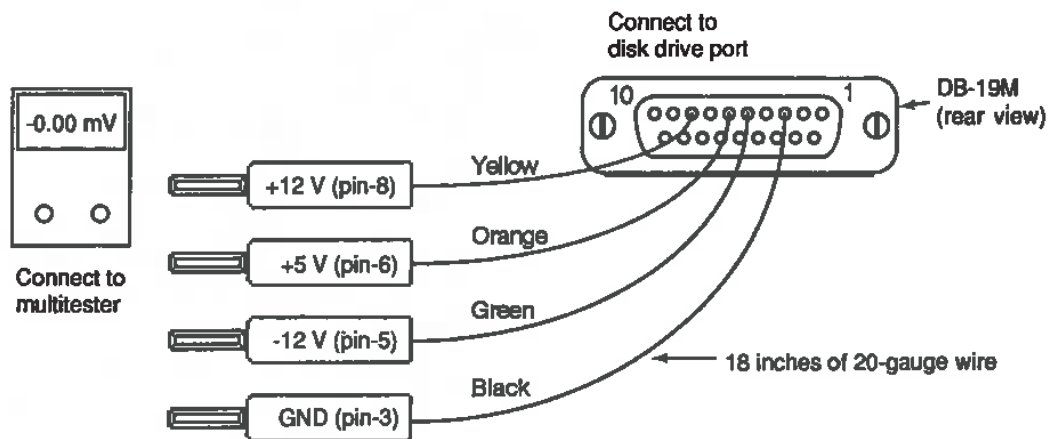

Figure 14-4 Voltage checking adapter for 128K to Mac SE.
Not for Lisas and Mac XL's.

To make this adapter, you'll need a DB-19M connector, a D-19 hood, 18 inches each of yellow, orange, green, and black 20-gauge wire, and four plugs (generally banana), one yellow, one orange, one green, and one black to fit your multimeter. You could substitute any color wire, but yellow, orange, green, and black match the color code of the Mac SE's integral power supply harness. For consistency, try to use the same colors. Specifications for the SE power supply are given in Table 14-1.

Table 14-1 Voltage Specifications—Mac SE Power Supply

Supply	Specification	Typical	Desired
+5 V	+4.85 V to +5.20 V	+5.00 V	+5.00 V
+12 V sweep	+11.50 V to +12.50 V	+11.94 V	+12.00 V
+12 V disk	+11.50 V to +12.50 V	+12.61 V	+12.00 V
-12 V	-13.20 V to -10.80 V	-11.63 V	-12.00 V

Note that there are two independent +12.00-V supplies. The external voltage checking adapter provides test points for the +5-V, -12-V, and +12-V disk supplies. +12-V sweep is not available at the disk-drive connector.

Adjustments—SE Specific Supplement to Chapter 3

As shown in Figure 14-5, there are three (not 2) circuit boards inside the Macintosh SE. The analog board stands vertically along the right side of the computer (as seen from the back), the CRT board is mounted to the CRT socket connector, and the logic board is mounted horizontally on rails underneath the disk drive.

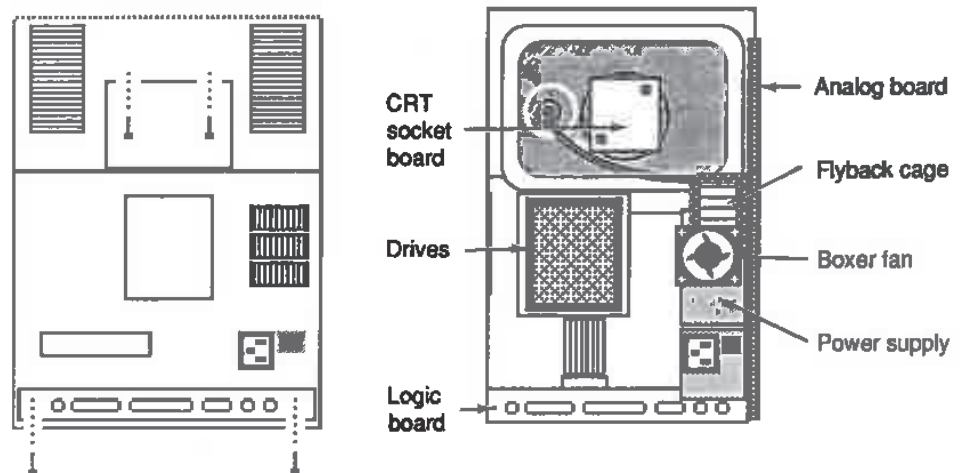

Figure 14-5 Inside Macintosh SE. The analog board stands vertically along the right side of the computer (as seen from the back), the CRT board is mounted to the CRT socket connector, and the logic board is mounted horizontally on rails underneath the disk drive.

The TPG tune-up procedure pertains strictly to the analog board. All work is done from the solder side, which is normally covered by a vinyl jacket, the same as other 9-inch Macs. The vinyl jacket provides a handy tune-up reference, plus it insulates you from exposed solder connections. In the event that the SE's vinyl jacket is missing, Test Pattern Generator contains a backup drawing of the jacket as shown in Figure 14-6.

To view the drawing on-line, simply choose Mac SE Video Alignment from the Reference menu. To print the drawing for posting over the workbench (which comes in handy), make sure there's a printer connected, turn it on, and choose Print... from the File menu.

Note that the directional arrow printed beside the height label on some SE board jackets is backwards. On these models, turning counterclockwise

does not increase the height as shown. It actually decreases the height. To avoid confusion, directional arrows are not shown on TPG's backup drawing.

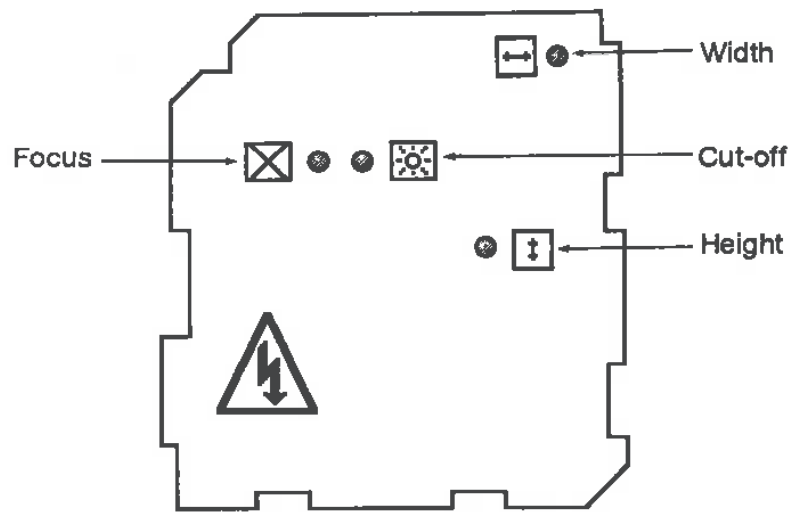

Figure 14-6 Mac SE video alignment. To view this backup drawing on-line, choose Mac SE Video Alignment from the Reference menu.

SE Tune-up Procedure

Not counting disassembly and reassembly, the entire tune-up procedure involves six (not seven) simple steps:

1. Adjust the cut-off.
2. Adjust the width.
3. Adjust the height.
4. Synchronize settings.
5. Center the results.
6. Adjust the focus.

The order of these steps is critical. When you do them out of sequence, each step cancels the other and you don't get anywhere! Plan on spending about an hour on your first tune-up. Once you've mastered the technique, subsequent jobs will take only take 10 to 15 minutes.

Adjusting the +5-V Supply The SE power supply is designed to monitor load levels and be self-adjusting within the voltage limits given in Table

14-1. Manual readjustment should not be necessary when adding memory modules and/or expansion cards. In the event that you do need to adjust the supply, a trimmer is located inside the case as shown in Figure 14-7.

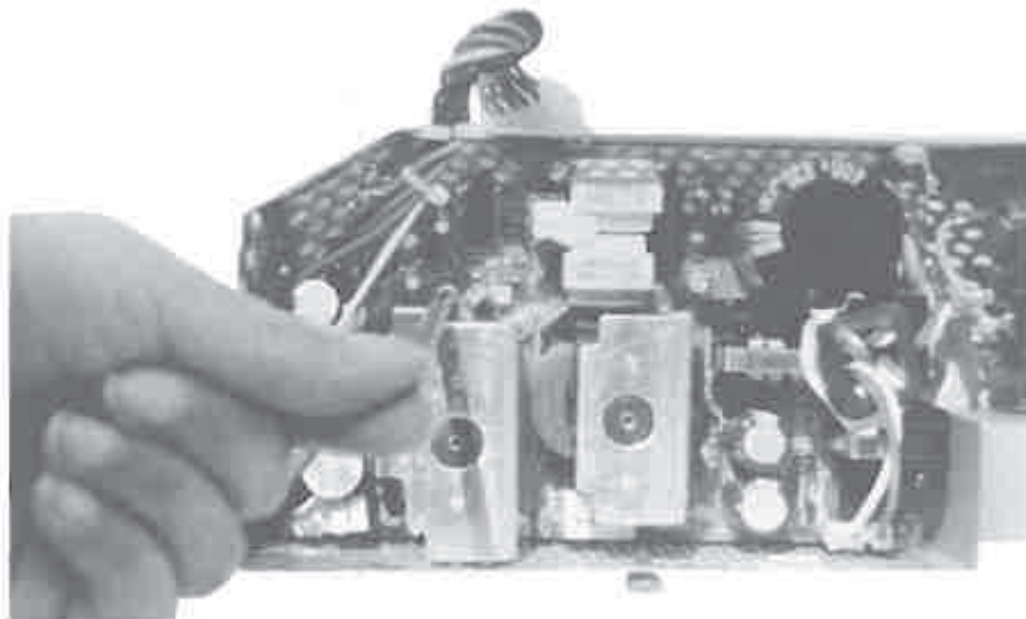

Figure 14-7 Mac SE internal power supply adjustment.

Normally, the access hole through the metal power supply case is blocked with heavy-duty tape.

Power Supply Problems—SE Specific Supplement to Chapter 4

The 2.5-A SE power supply is designed to accept any AC line voltage *within the ranges* given in Table 14-2.

Table 14-2 Acceptable Voltage Ranges for SE Power Supply

Voltage Range	Frequency
85 to 135 V AC	47 to 63 Hz
170 to 270 V AC	47 to 63 Hz

The input range is also self-setting. In this respect, the SE supply differs from the separate Lisa 2/10 to Mac XL power supply, and from the integral

power supply on the International 128K to Macintosh Plus analog board. Both units contain voltage jumpers that have to be set manually. Voltage conversion on the SE is instantaneous and fully automatic.

Dealing with the Vinyl Jacket

Thankfully, the SE's vinyl jacket is not attached with sticky pads. Instead, 5 plastic push-pins secure the jacket as indicated in Figure 14-2. Removing the pins takes only two seconds. There's no sticky mess to clean, which makes working on this board a pleasure.

Wiring Harnesses

All wiring harnesses in the Macintosh SE are 18 AWG. The connectors are also improved. As a result, voltage drop is minimized. Replacement harnesses are generally not necessary.

Focus Control Problems

When the focus control has absolutely no effect, the primary suspects are resistors R6 (100 k Ω) on the CRT Socket Board and R26 (1 M Ω) on the SE analog board. These resistors correspond to R16 and R9 on the 128K to Mac Plus analog board. Test them exactly as described in Chapter 4. A good in-circuit reading for R6 is typically 109.5 k Ω . A good in-circuit reading for R26 is 811 k Ω . In practice, neither R6 nor R26 is likely to fail because all SE's are supplied with an internal boxer fan.

Brightness Control Problems

When you can't turn up the brightness without causing excessive distortion (referred to as buckling and blooming), it's a sure sign of leaky electrolytic capacitors. On the SE analog board, the principal suspects are C7, C9, C13, and C24. Refer to Figure 14-8 for approximate locations. Set up an inspection light and test the caps exactly as described in Chapter 4.

Video Problems—SE Specific Supplement to Chapter 5

When the computer powers up normally (when it bongs on startup) but the display flickers and/or quits, it usually means trouble with one of the following parts:



Display Symptom	Solution
1. Collapses to vertical line	Resolder C15, P1, L2 Replace C15
2. Jitters and/or has worms	Replace T2
3. Makes a ringing noise	Replace T2
4. Makes an ozone smell	Replace T2
5. Distorts horribly/fades/darkens	Replace Q2, T2
6. Makes a burning smell/smokes	Inspect/replace C15, P1, L2 Replace Q2, T2
7. No raster, completely dark	Replace U1
8. Collapses to a horizontal line	Suspect U2
9. Collapses to a pinprick	Reconnect CRT yoke cable

In most cases, the problem is at the top of the analog board in the area of C15, P1, L2, Q2, and T2. The schematic relationship between these parts is shown in Figures 14-9 to 14-12, courtesy of Soft Solutions.

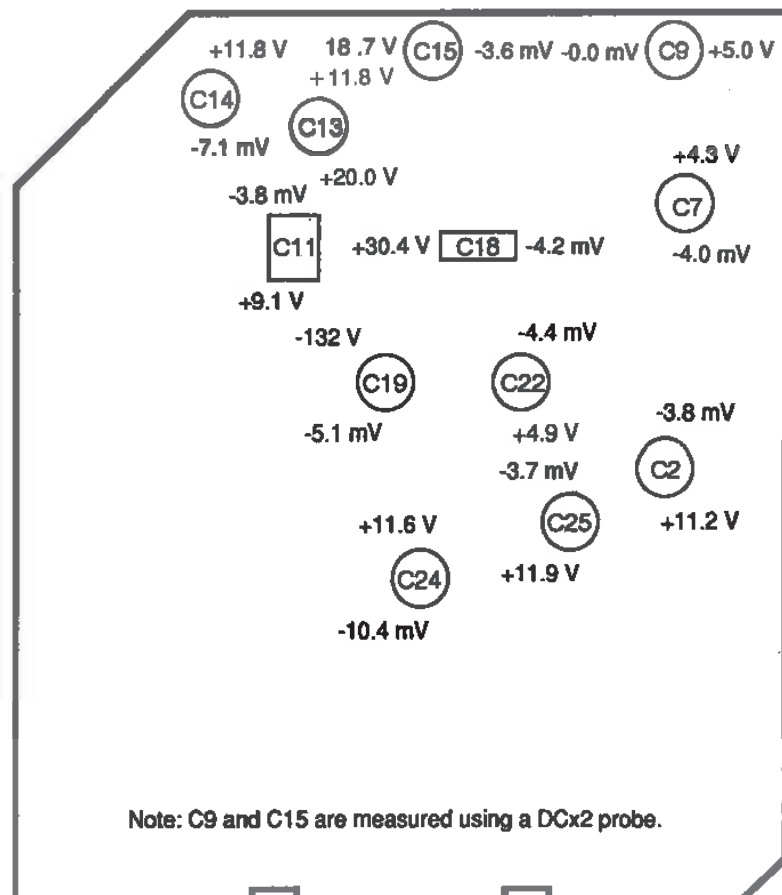

Figure 14-8 Mac SE. The approximate electrolytic capacitor locations as seen from component side of the analog board.

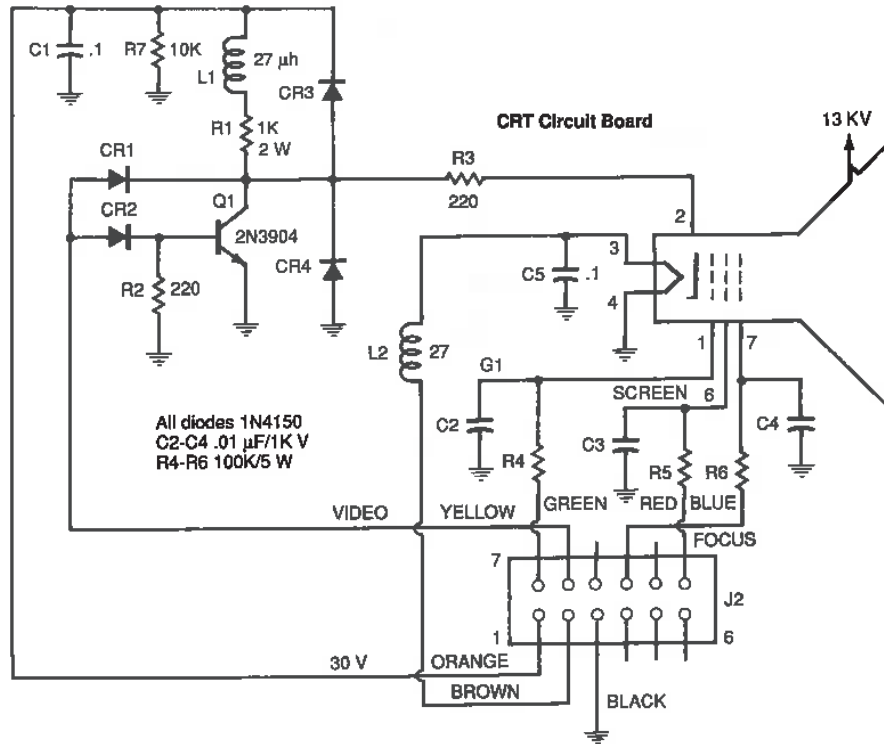

Figure 14-9 Macintosh SE CRT circuit board schematic. *Courtesy of Soft Solutions.*

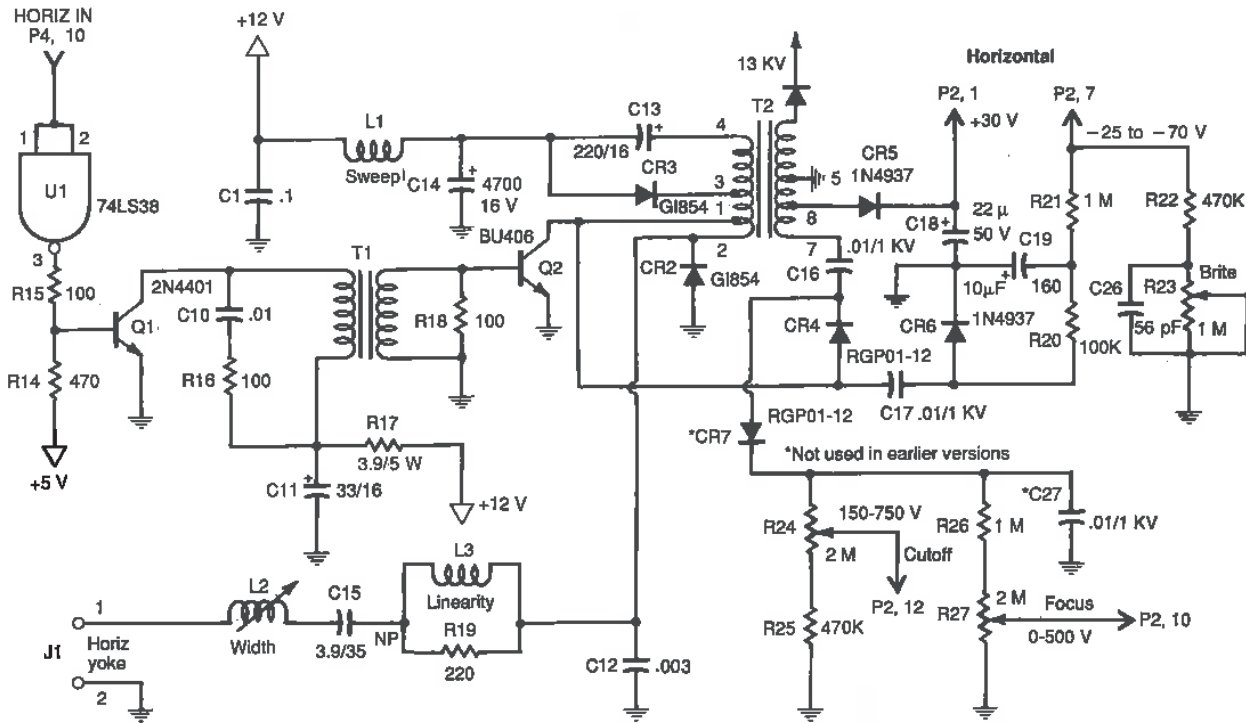

Figure 14-10 Macintosh SE analog board—horizontal schematic. *Courtesy of Soft Solutions.*

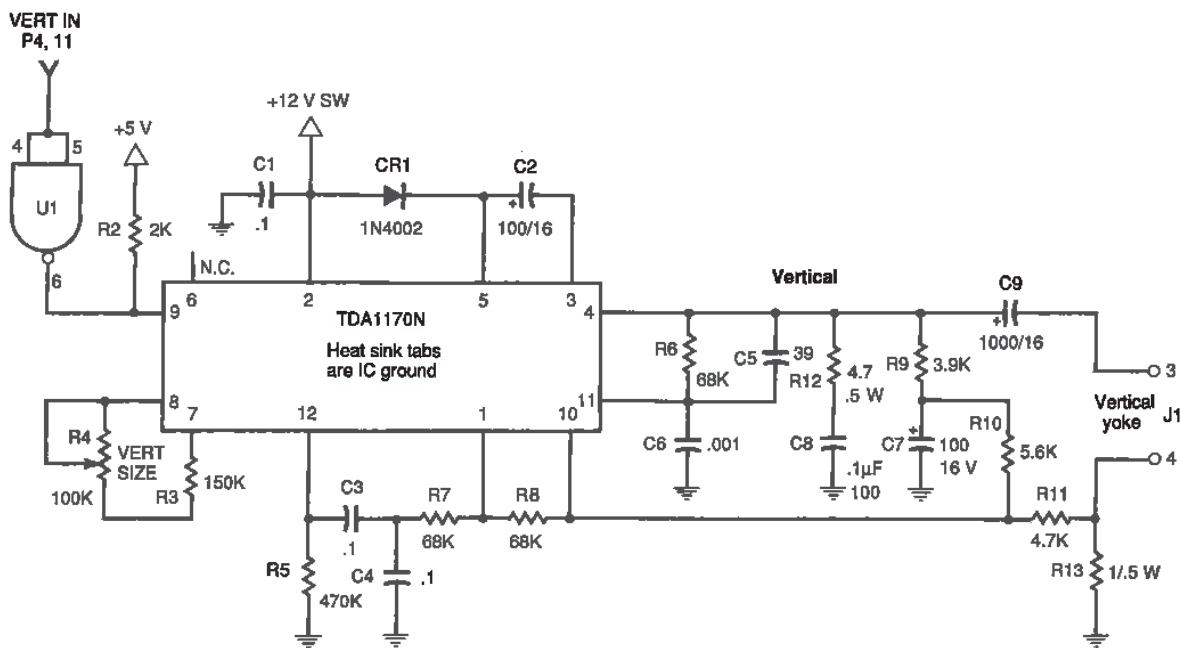

Figure 14-11 Macintosh SE analog board schematic—vertical circuits. *Courtesy of Soft Solutions.*

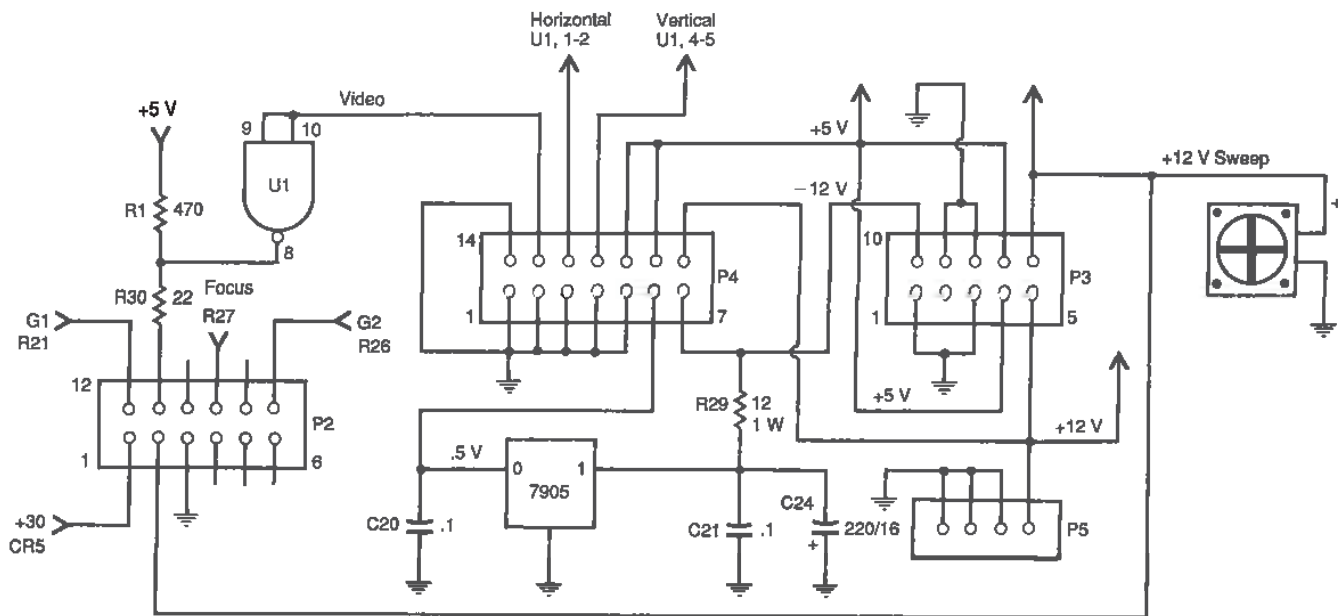

Figure 14-12 Macintosh SE analog board schematic—harness wiring and voltage regulation. *Courtesy of Soft Solutions.*

For use with these schematics, Table 14-3 identifies the wiring connectors. Table 14-4 gives the CRT yoke cable color codes. Table 14-5 provides a handy cross reference to both versions of the 128K to Mac Plus analog board. The video circuits on all three boards are virtually identical. If you need to know more about testing Q2 (OEM BU 406) for example, look it up in Table 14-5, find that it's the same as Q1 on the U.S. version of the 128K to Mac Plus board, then read up on Q1 in Chapter 5. Everything you need to know to repair the Mac SE analog board is contained in that chapter.

Table 14-3 Connector Assignments—Macintosh SE Analog Board

Connector	Pins	Function
P1	4	Analog board to CRT yoke
P2	12	Analog board to CRT socket board
P3	10	Analog board to power supply
P4	14	Analog board to logic board
P5	4	Analog board to hard disk

Table 14-4 Color Codes—P1 Connector to CRT Yoke Cable

P1-Pin	Color	Function
4	Green	Horizontal yoke
3	Yellow	Ground
2	Red	+5.00 V
1	Blue	Vertical yoke

Table 14-5 Analog Board Cross References

SE	U.S. 128K-Plus	International 128K-Plus	OEM
C15	C1	C2	3.9-mfd HF NP capacitor
CR2	CR5	CR5	GI854 rectifier
CR3	CR1	CR1	GI854 rectifier
L2	L2	L2	Width coil
P1	J1	J1	Yoke plug
Q2	Q3	Q2	BU 406 transistor
R6	R16	R20	100-k Ω resistor
R26	R9	R12	1-M Ω resistor
T2	T1	T1	Flyback transformer
U2	U2	U2	SN74LS38N IC

In addition, Appendix E contains a complete parts list for the SE analog board. A complete parts list for the SE CRT board is in Appendix F.

Dead Sets—SE Specific Supplement to Chapter 6

When troubleshooting dead SE's, bear in mind that the switching power supply is self-contained. For general service procedures, refer to *Macintosh II Repair and Upgrade Secrets*. The other usual problems, CR2, CR3, Q2, T2 and the 7905C regulator are serviced exactly the same as described in Chapter 6.

Power Supply Upgrades—SE Specific Supplement to Chapter 7

Many of the failure avoidance strategies outlined in Chapter 7 for the 128K to Mac Plus analog board have been incorporated into the design of the Mac SE analog board. As shown in Figures 14-13 and 14-11, the SE already has an internal fan, 18-AWG wiring harnesses, bigger rectifiers, heavier-duty filter caps, etc. The one *big* exception is C15 (3.9 mfd BP {HF} 35 V 85 °C) which remains at 35 V. For maximum reliability, this part can be upgraded to 3.9 mfd NP HF 100 V 85 °C, for all of the reasons previously explained.

A related improvement is the metal case which surrounds the disk drive. This case keeps the internal fan from pulling dust into the drive, as can easily be verified by placing a hand in front of the disk opening.

SE Analog Board—Removal and Installation

This summary reviews the complete analog board removal and installation procedure. It's generally not necessary to remove the board in order to repair it, but you may wish to do so if you decide to ship your board to a mail-order service center.

Removal Instructions

1. If the set is on, power down normally and switch off the power.
2. Physically disconnect the power cord from the wall outlet.
3. Remove all rings, watches, bracelets, and other jewelry. Open the case as shown in Figure 14-1.
4. Disconnect the P4 (analog board) to J12 (logic board) cable by squeezing the release lever at the J12 end and pulling straight up.
5. Put on safety goggles. Discharge the CRT through a 10-meg resistor as shown in Figures 1-13 to 1-15.
6. As shown in Figure 5-16, remove the high-voltage lead from the top of the flyback transformer to the anode well of the CRT.

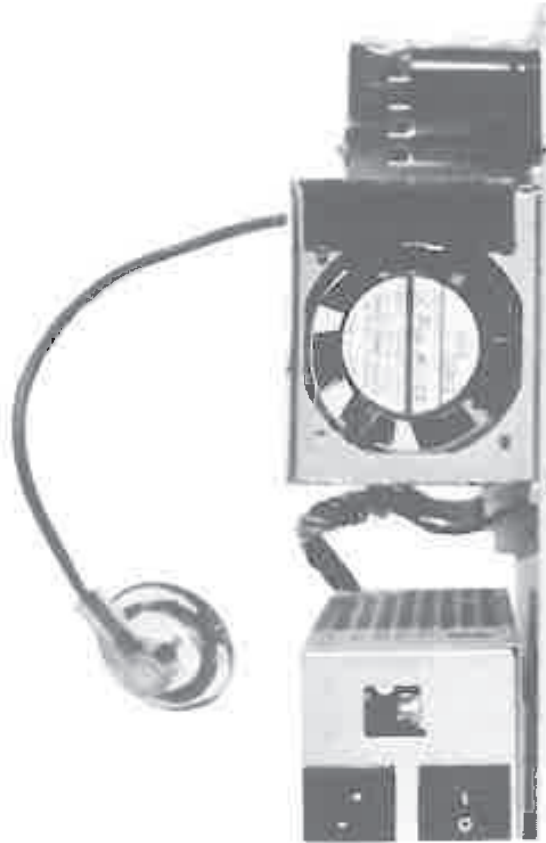

Figure 14-13 Mac SE internal boxer fan.

7. Disconnect the P1 (analog board) to CRT (yoke) cable. As shown in Figure 7-4, use a 6-inch to 8-inch long $\frac{1}{8}$ -inch screwdriver to pry back the connector lock and pull the wires straight back.
8. Disconnect the P2 (analog board) to CRT (socket) cable. Squeeze the release lever at the P2 end, and pull straight back.
9. Disconnect the internal hard drive to P5 cable (if applicable) at the P5 end.
10. Unscrew the ground wire. As shown in Figure 14-2, the ground wire extends from the power supply to the back of the frame.
11. Unscrew the analog board. As shown in Figure 14-2, there are two screws in the lower rear corner of the board and two screws on the right side of the board. All four screws hold the board to the SE's metal frame. Don't try to lift the analog board away just yet. The power supply has to be disconnected first.
12. Unscrew the power supply. As shown in Figure 14-2, there are two screws on the left side of the board and two screws on the right side of the board. All four screws hold the power supply to the analog board.

13. Separate the analog board from the power supply. Slide the analog board backwards $\frac{1}{4}$ inch or so (to clear the forward support points,) tilt it out enough to reach the power supply harness to P3 connector, and disconnect it at the P3 end.
14. Remove the analog board. Be careful that the loose wiring harnesses don't snag on the neck of the CRT.
15. If necessary, remove the power supply. With the analog board out of the way, the power supply will lift right out. While the two are screwed together, there's not enough room to remove either one.

If you intend to send the analog board out for service, remove the grounding plate from the lower back corner of the board, the brightness control knob from the lower front corner of the board, and the P4 (analog board) to J12 (logic board) cable from the P4 connector. That precludes the possibility of their getting lost at the service center. Keeping them at home, where they can't get lost, is a good failure avoidance strategy.

Installation Instructions

1. Install the brightness control knob. As shown in Figure 7-5, it fits over the brightness control shaft in the lower front corner of the board.
2. Plug the P4 (analog board) to J12 (logic board) cable into J12.
3. Install the grounding plate. As shown in Figure 14-2, it covers the two screw holes at the lower back corner of the board. If the grounding plate is missing, or if you never had one (because someone else lost it), fabricate a new one from aluminum step flashing or thin sheet metal. Cut up the top of a coffee can with tin snips if necessary. The approximate size is indicated on the board.
4. Check for the presence of a vinyl jacket. As shown in Figure 14-2, this jacket provides a handy tune-up reference and insulates you from exposed solder connections. If necessary, remount the vinyl jacket with five plastic push-pins.
5. If necessary, reposition the power supply by placing it on the chassis.
6. Join the power supply to the analog board. Rest the analog board on the chassis support points. Tilt the analog board towards you, and plug the power supply harness into P3. Screw the power supply and the analog board back together using four Phillips-head machine screws and four lock washers.
7. Remount the analog board. As shown in Figure 14-2, there are four support points for the board. The first two support points are along the front edge of the cabinet. The upper point looks like an upside-down toy clothespin. The third and fourth support points are metal tabs extending from the top of the chassis. Make sure the board is locked into all four

support points, then fasten the board using four sheet metal Phillips-head screws and lock washers. Two screws mount through the grounding plate at the lower left corner of the board. Two screws mount part way up the right side of the board.

8. Reattach the ground wire extending from the power supply to the back of the frame using a gray-metal Phillips-head screw and a lock washer. Tighten the ground screw firmly. If it loosens, the Macintosh SE will make a buzzing sound.
9. Plug the P4 (analog board) to J12 (logic board) cable into J12.
10. Plug the CRT (socket) to P2 (analog board) cable into P2. Gently slide the CRT socket board all the way home on the neck of the CRT.
11. Plug the CRT (yoke) to P1 (analog board) cable into P1.
12. As shown in Figure 5-16, reconnect the high-voltage lead from the top of the flyback transformer to the anode well of the CRT.
13. Reconnect the internal hard drive to P5 cable (if applicable) at the P5 end.
14. Perform a power up test: Plug the AC cord into an outlet and switch on the power. The Macintosh should bong. The usual floppy disk icon with a blinking question mark should appear. If the set bongs, but the display is dark, raise the brightness level by adjusting R23 with the front panel brightness control knob.
15. Realign the video (the height, width, centering and so on) as explained in Chapter 3.

Audio Upgrades—SE Specific Supplement to Chapter 8

The 63- Ω internal speaker in the Macintosh SE faces forward. It's mounted behind an integral speaker grill, located just above the brightness control knob at the lower left corner of the front cabinet. An additional speaker grill is not necessary.

In addition, even though the OEM speaker is exactly the same model used in older Macs, the electronics are different, and the Macintosh SE's frequency response is much better. You can easily hear TPO's 100 cycle test tone through the internal speaker. That same test is barely audible on older (128K to Macintosh Plus) models, even with a high-quality *external* speaker. TPG's audio tests will prove that SE's have substantially enhanced sound reproduction.

Video Upgrades—SE Specific Supplement to Chapter 9

The various video upgrades discussed in Chapter 9 apply equally well to the Macintosh SE. Figure 14-14 gives an SE specific wiring diagram for the TTL video adapter.

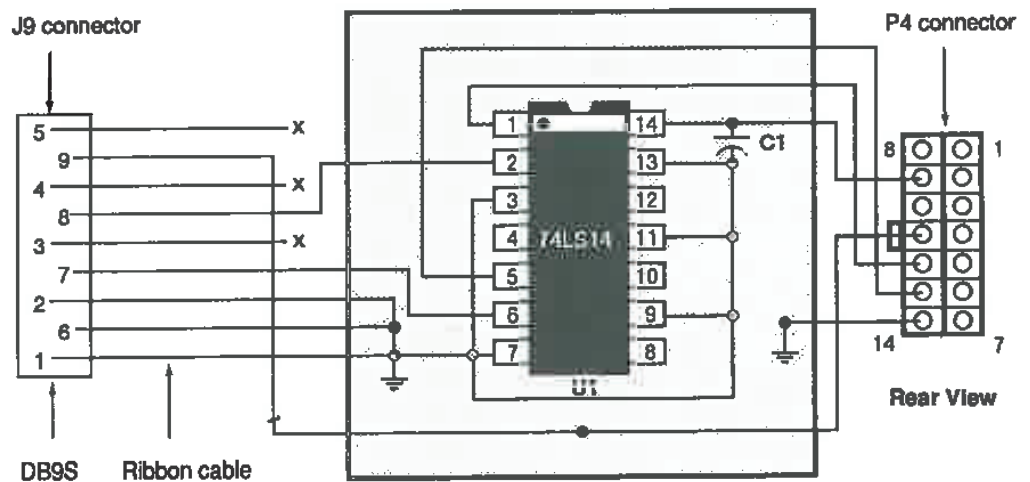

Figure 14-14 Wiring diagram for Macintosh SE TTL video adapter.

Note: If the Mac SE has an internal hard drive, stick the TTL video adapter to the chassis. Do not mount it on top of a hard drive controller card!

Logic Boards—SE Specific Supplement to Chapter 10

All Mac SE logic boards are mounted on discontinuous metal rails. Other than speaker cable, the analog to logic board (power/video) cable and the disk drive to logic board (disk drive data) cables, there's no mechanical connection. Once you've opened the set and disconnected as many cables as you can get at, lay the CRT face down on a towel such that the solder side of the board is toward your chest. As suggested in Figures 14-16 and 14-17, the side of the logic board on your right has been jigsawed to simplify removal. Slide the board up just enough so the saw cuts line up with the openings in the rails, then pivot the board on the left rail, and reach in with your right hand to disconnect the speaker cable from J11. After disconnecting the speaker cable, the board will be completely free, and it'll simply lift away.

Removing the SE logic board, especially upgraded SE logic boards, is much simpler than removing 128K to Mac Plus boards. Just remember that it swings out through the jigsaw cuts. It doesn't pull all the way out like older logic boards.

Static Electricity Warning: Macintosh SE logic boards are more sensitive to static electricity than older models. Be very careful when handling the board. Wear an antistatic wrist strap. Lay a sheet of aluminum foil on the workbench. Obtain a surge suppressor with an integral static discharge pad, mount it on the workbench, and tap it frequently, or stand on an antistatic mat. Take every reasonable precaution. Destroy the custom chips, and you may have to buy a whole new board!

SE Memory Upgrades

The Macintosh SE uses detachable plug-in memory modules (SIMMs), just like the Macintosh Plus. Memory upgrades are performed by unplugging the stock 256K modules and replacing them with higher capacity units. High-capacity 1Mb SIMMs are compared to stock 256K (1/4Mb) SIMMs in Figure 14-15.

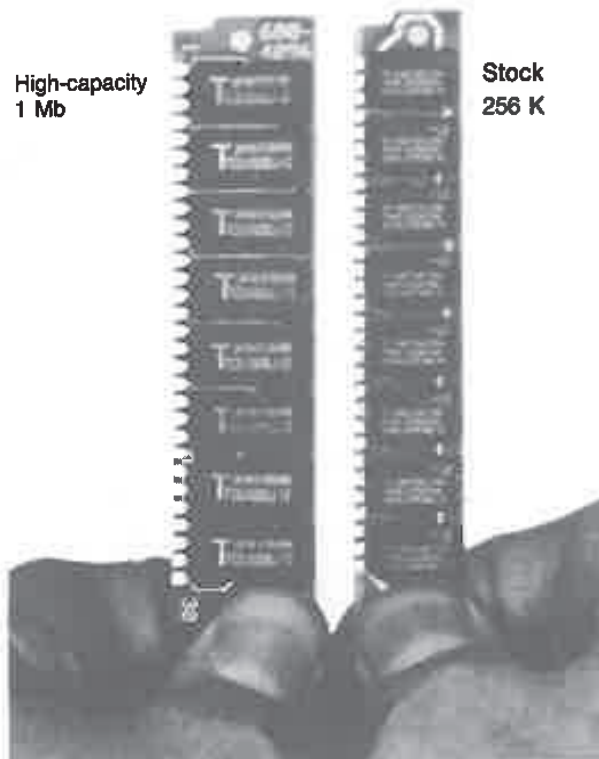

Figure 14-15 High-capacity 1Mb vs stock 256K (1/4Mb) single in-line memory modules.

SIMM Upgrades for the Original SE Logic Board

Original Macintosh SE logic boards are marked "820-0176-A" or "820-0176-B," just to the right of the MC68000 processor. As shown in Figure 14-16, SIMMs on the original logic board are arranged in pairs. The hierarchy starts from the middle of the board and works its way from left to right to the front of the board.

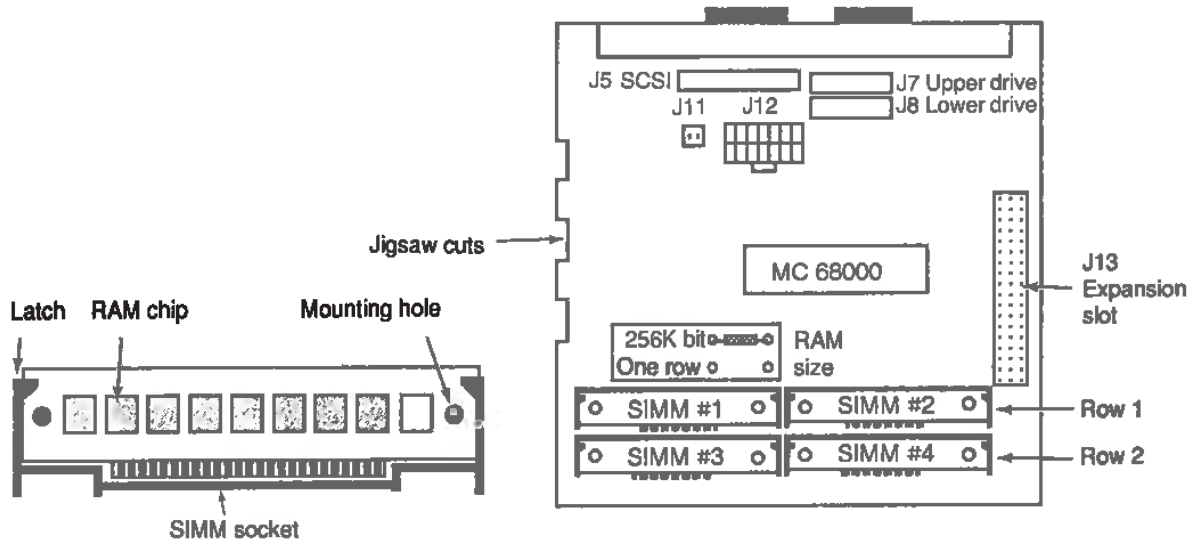

Figure 14-16 SIMM detail for original Macintosh SE logic board.

The 16 chips on SIMMs 1 and 2 are electrically connected in one row. The 16 chips on SIMMs 3 and 4 are electrically connected in another row. OEM references to "one row" on the original SE logic board actually refer to SIMMs 1 and 2. OEM references to "two rows" on the original SE logic board refer to all four SIMMs.

1Mb to 2Mb SIMM Upgrades for the Original SE Logic Board This upgrade involves removing all four of the stock 256K SIMMs, and installing megabit SIMMs in row 1. The remaining pair of 256K SIMMs is not used. Row 2 is left empty.

In addition, R35, a 150- Ω 5% carbon film resistor located at grid reference F4, has to be removed, and R36, a missing 150- Ω 5% carbon film resistor also at grid reference F4, has to be installed. New 150- Ω resistors are color-coded brown green black, gold. In practice, you can desolder R35, clean the holes at R36, and reinstall the very same part. A new resistor is generally not needed.

Note that R35 is labeled (only) "256 KBIT." As indicated by the addition of the word (only), that label is intended to be a true or false statement. If it's

not true that all of the installed SIMMs are 256K SIMMs, R35 has to come out. In this case, R35 has to come out, because one row contains 1024K (megabit) SIMMs.

The {only} "ONE ROW" label beside R36 is also intended to be a true or false statement. Previously, only "ONE ROW" was false, because *both* rows contained SIMMs. In this case, R36 has to go in, because the *second* row is left empty.

Installing this upgrade normally shrinks the display. Finish up by readjusting the video circuitry, if necessary, as explained in Chapter 3.

1Mb or 2Mb to 2.5Mb SIMM Upgrades for the Original SE Logic Board This upgrade involves removing all of the existing SIMMs, installing a pair of megabit SIMMs in row 1, and reinstalling a pair of 256K SIMMs in row 2. Any leftover SIMMs are not reused.

Both R35 and R36 (assuming either is present) have to be removed. As explained previously, R35, labeled "256 KBIT," is *only* used if it's true that both rows contain 256K SIMMs. That's not true in this case, so R35 has to come out. R36, labeled "ONE ROW," also has to come out because *two* rows of SIMMs are installed.

Installing this upgrade normally shrinks the display. Finish up by readjusting the video circuitry, if necessary, as explained in Chapter 3.

1Mb, 2Mb, or 2.5Mb to 4Mb SIMM Upgrades for the Original SE Logic Board This upgrade involves removing all of the existing SIMMs and replacing them with two or four megabit SIMMs, as necessary. Any previously installed 256K SIMMs are not reused.

Both R35 and R36 (assuming either is present) have to be removed. As explained above, R35, labeled "256 KBIT," is only used if it's true that both rows contain 256K SIMMs. That's not true in this case, because both rows contain megabit SIMMs. R36, labeled "ONE ROW," also has to come out because two rows of SIMMs are installed.

As a result of a 4Mb upgrade, the display will typically shrink from 7.11 inches \times 4.75 inches to 6.875 inches \times 4.5 inches. Finish up by adjusting the video circuitry so that the full size is restored as explained in Chapter 3.

SIMM Upgrades for the DIP SIMM SE Logic Board

DIP SIMM Macintosh SE logic boards are marked "DIP SIMM MAC SE, 820-0250-A, 1988, 630-4250," just to the right of the MC 68000 processor. As shown in Figures 14-17 and 4-21, a removable shorting block is used at J16 in place of the usual 150- Ω memory size resistors. As a result of the single shorting block, the upgrade procedure is completely different.

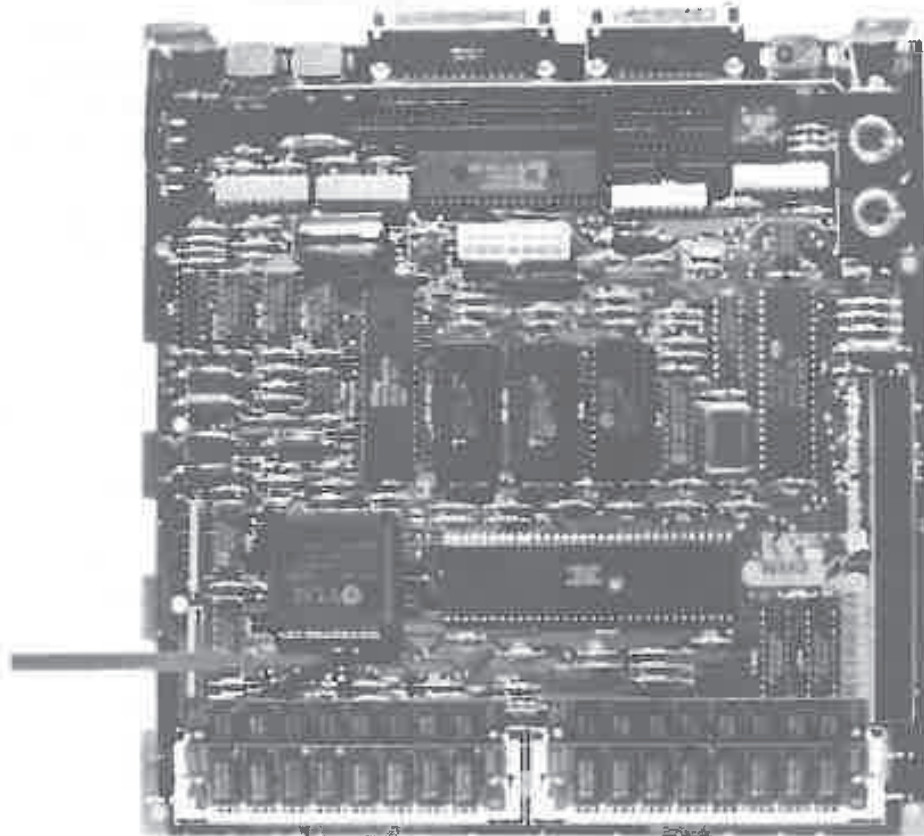

Figure 14-17 DIP SIMM Macintosh SE logic boards are marked "DIP SIMM MAC SE, 820-0250-A, 1988, 630-4250," just to the right of the MC 68000 processor. The plastic wand points to the removable shorting block.

1Mb to 2Mb SIMM Upgrades for the DIP SIMM SE Logic Board This upgrade involves removing all four of the stock 256K SIMMs and installing megabit SIMMs in row 2. The remaining pair of 256K SIMMs is not used. Row 1 is left empty. Note that this is exactly the opposite of the upgrade procedure for the original logic board!

In addition, a 2-pin shorting block located at grid reference F4 has to be moved from its existing right-center position, which shorts out the pins labeled "1M," and placed over the left-center position, which shorts out the pins labeled "2/4M."

Installing this upgrade normally shrinks the display. Finish up by readjusting the video circuitry, if necessary, as explained in Chapter 3.

1Mb or 2Mb to 2.5Mb SIMM Upgrades for the DIP SIMM SE Logic Board This upgrade involves removing the existing SIMMs as necessary, installing a pair of 256K SIMMs in row 1, and installing a pair of megabit SIMMs in Row 2. Any leftover SIMMs are not reused. Note that this is exactly the opposite of the upgrade procedure for the original logic board!

In addition, a 2-pin shorting block, located at grid reference F4, has to be moved from its existing position and placed perpendicular to the center position, so that none of the three pins are shorted. You could also remove the block entirely, but then it wouldn't be handy should you ever decide to restore the original memory configuration.

Note that while the "2/4M" label may suggest that the shorting block should be installed over the left two pins for 2.5Mb, that's just not the case. When the left two pins are shorted, all you end up with is 2Mb, regardless of how much RAM is installed!

This upgrade normally shrinks the display. Finish up by readjusting the video circuitry, if necessary, as explained in Chapter 3.

1Mb, 2Mb, or 2.5Mb to 4Mb SIMM Upgrades for the DIP SIMM SE Logic Board This upgrade involves removing the existing SIMMs as necessary, installing a pair of megabit SIMMs in row 1, and installing a second pair of megabit SIMMs in row 2. Any previously installed 256K SIMMs are not reused.

In addition, a 2-pin shorting block located at grid reference F4 has to be moved from its existing position if necessary and parked over the center position, so that none of the three pins are shorted. You could also remove the block entirely, but then it wouldn't be handy should you ever decide to restore the original memory configuration.

Note that while the "2/4M" label may suggest that the shorting block should be installed over the left two pins for 4Mb, that's just not the case. When the left two pins are shorted, all you end up with is 2Mb, regardless of how much RAM is installed!

As a result of a 4Mb upgrade, the display will typically shrink from 7.11 inches \times 4.75 inches to 6.875 inches \times 4.5 inches. Finish up by adjusting the video circuitry so that the full size is restored as explained in Chapter 3.

Troubleshooting SIMM Upgrades

If you get a sad Mac icon as shown in Figure 10-7 on power-up, or if you get a black-and-white striped screen as shown in Figure 13-14, or a checkerboard screen, instead of the usual blinking floppy disk icon, it usually means one or more of the SIMMs are loose. These are the same symptoms you get on a Macintosh Plus. To track it down, follow the troubleshooting procedures described in Chapter 10.

Keyboard—SE Specific Supplement to Chapter 11

The Macintosh SE uses a desktop bus which is incompatible with older style 128K to Macintosh Plus keyboards. In addition, ADB (Apple Desktop Bus) compatible keyboards are optional. For service information on Apple-brand

ADB keyboards, refer to *Macintosh II Repair & Upgrade Secrets*. For repair information on the ADB in general, refer to the next section.

Mouse—SE Specific Supplement to Chapter 12

The Macintosh SE uses a desktop bus which is incompatible with the older style Lisa/Macintosh mouse. The bundled OEM mouse, made by Logitech, bears model number A9MO331. As shown in Figure 14-18, mouse logic is self-contained on a 28-pin ZC8406P PROM (Programmable ROM) chip. On the older Macs, mouse logic is on the digital board.



Figure 14-18 Inside the A9MO331 bus mouse.

Note that there are only three wires in the ADB mouse cable. Color codes are referenced directly on the integral circuit board. Pinouts for the 4-pin ADB mouse connector at the other end of the cable are given in Figure 14-19.

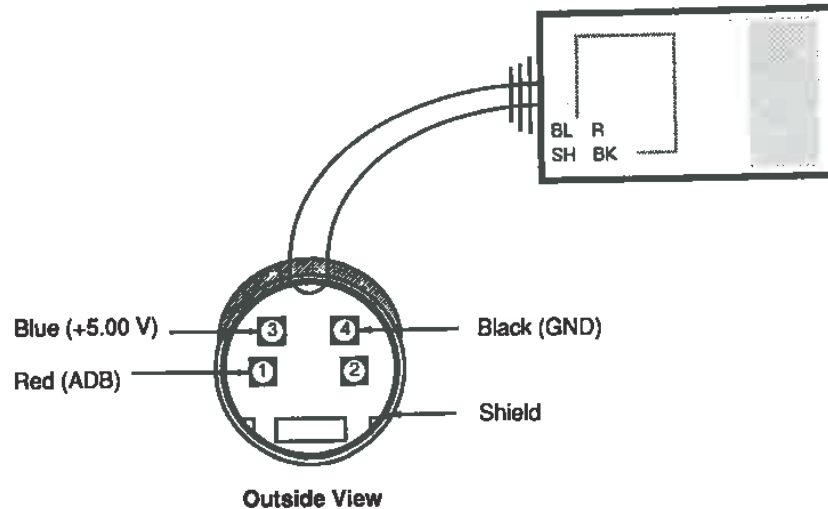

Figure 14-19 Pinouts for the ADB mouse connector.

The mouse case is held together by four Phillips-head screws. There are no hidden locks. The OEM microswitch used in model number A9MO331 is an OMRON D2F-D1L83W.

When cleaning the mouse, take care to reorient the mouse ball retaining ring such that the slippery pad is towards the edge of the mouse. It's possible to install it backwards. In that case, the slippery pad will be towards the middle of the mouse and it won't track as well.

Servicing the Desktop Bus

When ADB devices (keyboard and mouse) no longer respond, the usual problem is a shorted bus filter. As shown in Figures 14-20 and 14-21, the bus filter (Tokin part number D-16C 4288) is located on the logic board, right behind the ADB connectors.

Test the filter with an ohmmeter. Turn the Macintosh SE off, and disconnect the power cord from the wall outlet. Set the meter to read low ohms and clip the black lead to the chassis. Touch the red probe to each of the filter's four leads one at a time. If more than one pin is grounded ($0.00\ \Omega$), the filter is bad. Replace it with a new filter, and everything will be OK.

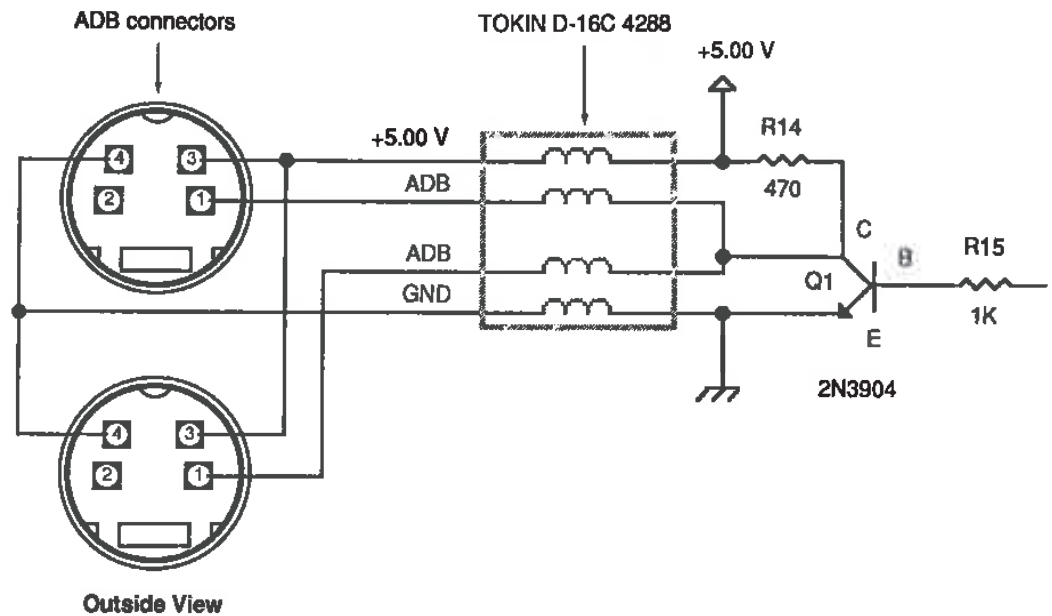

Figure 14-20 ADB schematic.

Expansion Card Upgrades

The Macintosh SE contains a built-in expansion slot. The slot is internally connected to the MC 68000 CPU, eliminating the need for a processor clip. As shown in Figure 14-21, accelerator cards, coprocessor cards, and video boards plug into a solid EURO-DIN 96-pin connector. As a result, these upgrades operate reliably and are not subject to the corrosion problem that plagues clip-on products for older Macs. As shown in Figure 14-22, typical SE expansion cards measure 4 inches wide by 8 inches long.

When installing an oversized or an L-shaped card, be careful not to short out toroidal coils L2 and L3 located at grid references A12-B12. Some oversized cards have razor sharp solder joints directly above this area. Short out the coils, and you'll end up with the same problem described in Chapter 10 regarding SCSI upgrades for the 512Ke Macintosh.

As illustrated in Figure 14-21, there's just enough room on the logic board to fit a 4Mb (surface mount) SIMM upgrade together with an expansion card. If less expensive DIP SIMMs are used in the top row, they overlap the expansion connector and block the slot. On the original Mac SE logic board, that generally means you can't use DIP SIMMs with an expansion card, except as part of a 4Mb upgrade. In 90% of the cases, DIP SIMMs can be installed in slots 3 and 4 without interfering. On the newer DIP SIMM Mac SE logic board, DIP SIMMs can be used in any size upgrade because the insertion

order is reversed. Because of the physical restrictions, however, they should still only be installed in positions 3 and 4.

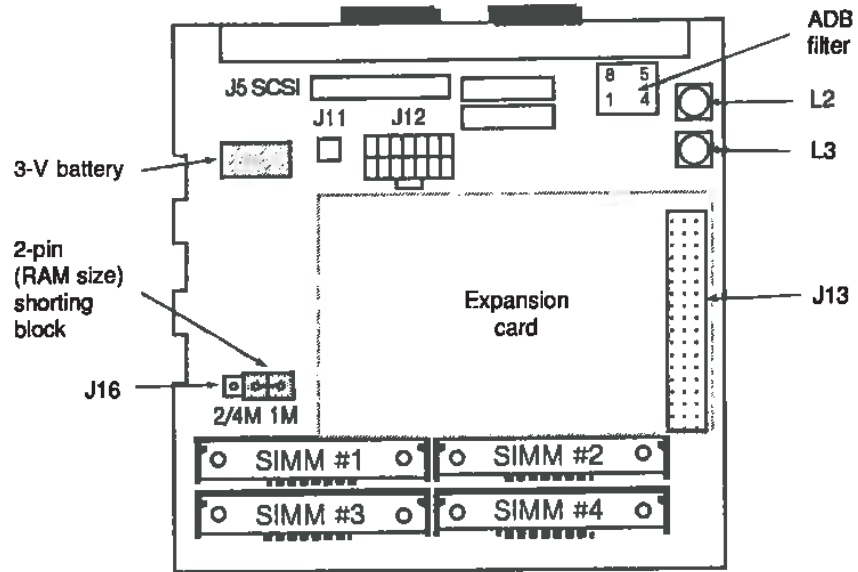

Figure 14-21 Expansion slot detail for DIP SIMM Macintosh SE logic board.

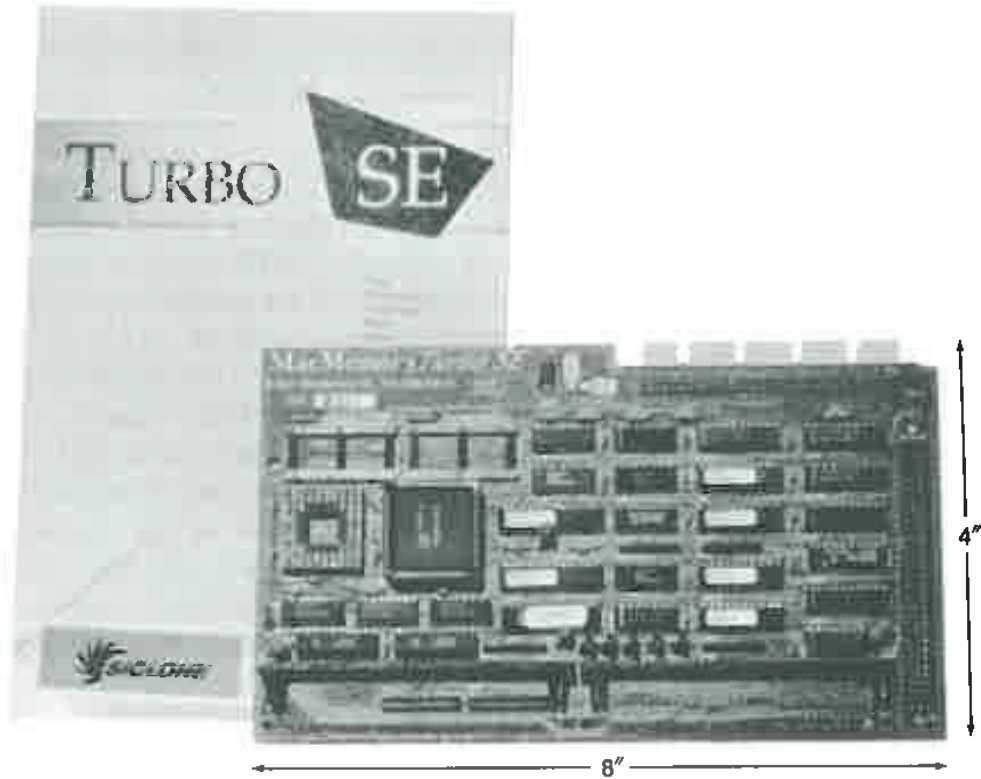

Figure 14-22 A typical Mac SE expansion card measures approximately 4 inches wide by 8 inches long.

Internal Hard Drive Upgrades

All Macintosh SE's are factory equipped with an internal SCSI connector, whether or not they're factory equipped with hard drives. That's another significant (albeit inobvious) difference between a Plus and an SE. The Mac SE is factory equipped to handle both external *and* internal SCSI drives. The Mac Plus isn't. The 99-W SE power supply can easily handle the extra load of an internal hard drive. The 55-W Mac Plus supply simply can't. Adding, popping and swapping drives in and out of a Mac SE is a simple nuts and bolts procedure, and any internal drive you replace can easily be fitted with a case for use as a backup drive or for use as an external drive on an older Mac. All you need to accomplish that is an External Drive Housing Kit.

External Drive Housing Kits

As shown in Figure 14-23, typical external drive housing kits consist of a shielded metal case, a 40-W power supply, an 8 CFM boxer fan, a presoldered wiring harness, two external SCSI connectors, a green read/write LED, both 3.5-inch and 5.25-inch mounting brackets (to accommodate either size drive), a 25- to 50-pin Mac to SCSI cable, and various nuts and bolts—everything you need except the SCSI drive itself. As higher capacity drives become available you can install them directly into an SE as necessary and still make use of the old drive you remove by fitting it with an external drive housing kit.

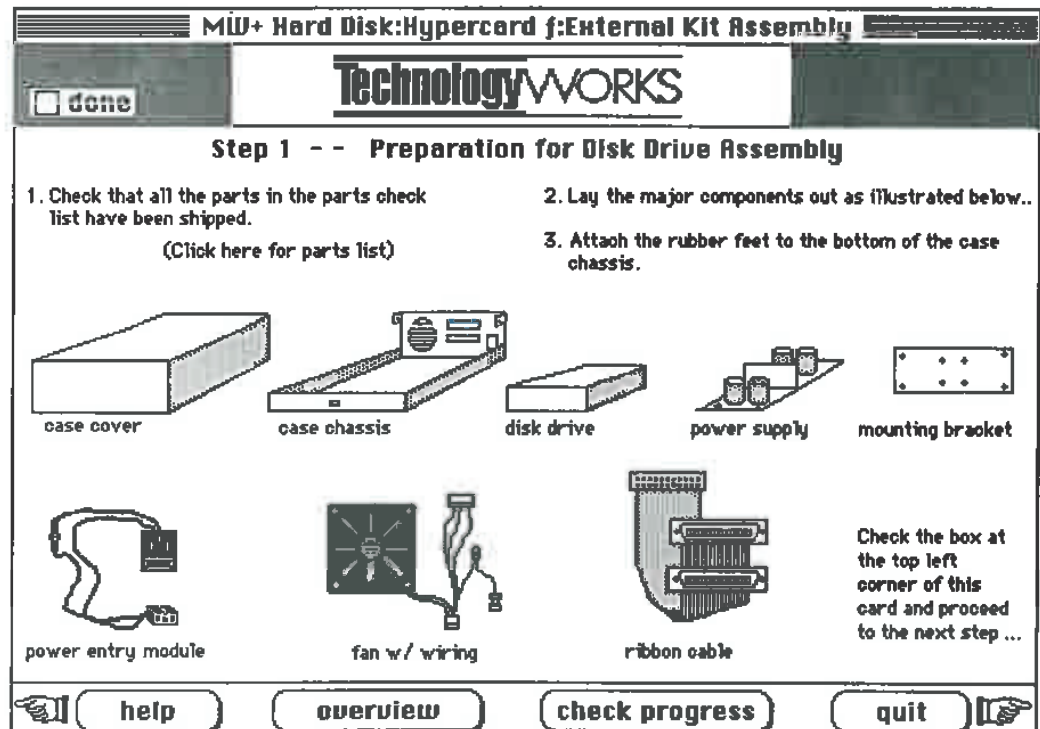

Figure 14-23 External drive housing kit—assembly details.
Courtesy of Technology Works.

Assembling an external drive housing involves just ten simple steps:

Drive Housing Assembly

1. Unpack and identify parts.
2. Insert AC wiring harness.
3. Install boxer fan.
4. Install SCSI ribbon.
5. Install drive brackets.
6. Check SCSI address.
7. Insert read/write LED.
8. Install drive.
9. Install power supply.
10. Check work. Power up!

The only tools required are Phillips-head and flat-head screwdrivers.

Assembled hard drive housings can either be stood on end or laid down. Either position is OK, but the hard drive should be formatted in the final position. In other words, if you've been running a drive inside or underneath a Mac then later decide to stand it on edge beside a Mac, you should back up the data before standing up the drive. Then, stand it on end, reformat it, and restore the data. The same procedure must be followed for any drives that have been standing that you want to lay down.

All things being equal, right side up horizontal positioning is better. Upside-down horizontal drives tend to stick. Vertical drives tend to topple. There's also a greater tendency to pick up a vertical drive while it's running. That can cause a head crash and result in lost data.

Right side up horizontal positioning is also a known cure for internal drives that tend to stick. Inside the SE, all hard drives are mounted upside down. In theory, hard drives should work equally well in any position, but in practice, some drives simply don't. Mount these same troublesome hard drives right side up in an external drive housing, and chances are, they'll work fine.

Internal Hard Drive Mounting Kits

Installing a hard drive into a Macintosh SE that was not originally equipped with one requires a special internal mounting kit. These consist of an SE-

specific hard drive bracket and a standard 4-wire power cable. Due to physical size limitations, Mac SE's are limited to 3.5-inch hard drives. There's no room for 5.25-inch models. In addition, the OEM internal kit requires that the upper floppy drive be removed.

Setting the SCSI ID

As shown in Figures 14-24 and 14-25, the SCSI ID is set by adding 2-pin shorting blocks to the embedded controller card. The Macintosh itself is factory set to 7. OEM internal hard drives are always set to 0. In theory, up to seven devices can be installed on the bus provided that each device is given a unique address. If you add an external hard drive, and it's also set to ID=0, one of the two drives will have to be changed. Since the startup procedure counts down (from ID=7 to ID=0), you can presumably speed things up a bit by setting the normal startup drive to ID=6.

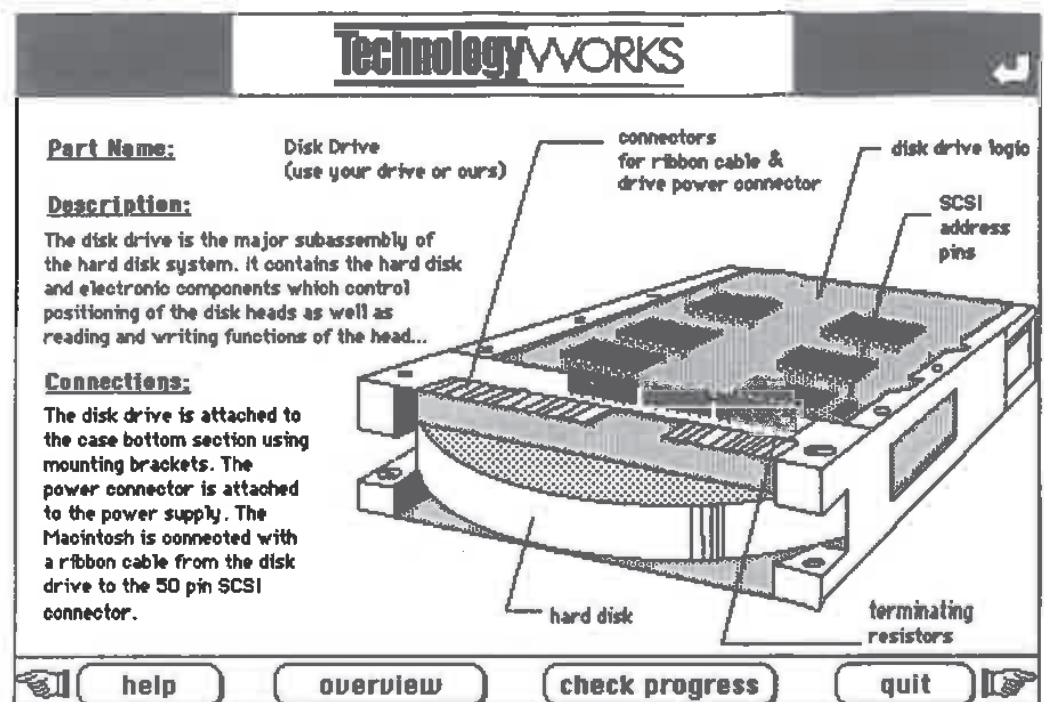

Figure 14-24 SCSI drive/controller details. Courtesy of Technology Works.

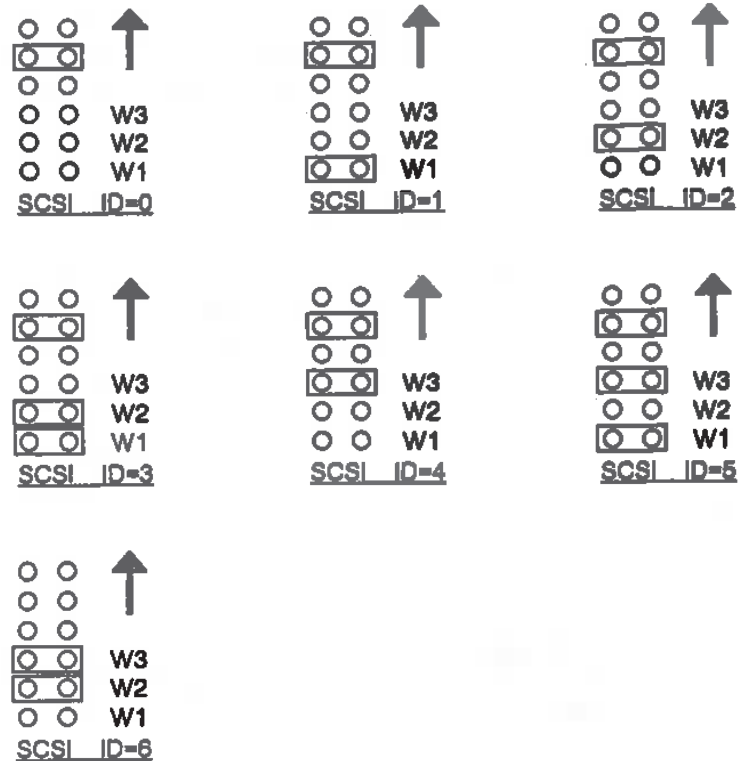

Figure 14-25 SCSI address pins—configuration details.

SCSI Terminators

As shown in Figure 14-24, plug-in terminating resistors are mounted on the bottom of all internal SCSI drives. Note that in Figure 14-24, the SCSI drive is shown upside down, so that the controller card faces up, the same as it appears inside the Macintosh SE. Three resistors are used. All three are 8-pin DIP 220- Ω /330- Ω dual terminators.

If the OEM resistors are missing, you can also attach an external terminator to the SCSI port, but these are much more expensive! External terminators only make sense when you have an external drive that is sometimes used as an only drive and sometimes used in the middle of a SCSI chain. To use a drive in the middle of a chain, you have to pull the terminators. Having them on an external plug makes it very easy to pull and install them as needed.

If the last SCSI cable is long enough, you may not need a terminator on the last device. Sometimes, having a second terminator doesn't matter one way or the other; sometimes a second terminator will keep a long-distance device from working.

There's been a lot of confusion in the Mac community over the use of terminators. All you really have to remember is that terminator is derived from the word "terminal" which means end. You need one at each end of the chain. By definition, terminators in the middle of the chain are a contradiction.

One final example: If the chapters in this book had been SCSI devices, there'd have been two terminators total. The first would have been at the beginning of Chapter 1. The second would have gone right here.

APPENDIX



Glossary

AC—an acronym for alternating current. In the United States, the polarity of the line voltage alternates 60 times per second. This differs from direct current where the polarity of the line voltage always stays the same.

Acronym—a term formed by combining the first letter of every word in a popular expression. “What you see, is what you get” becomes WYSIWYG.

ADB—an acronym for Apple desktop bus.

Ampere—a unit of measurement pertaining to the flow of electricity (current).

Analog—a short form of “analogous” which implies comparison.

Analog Board—the combination power supply and video board found in 128K to Macintosh Plus computers. Operates by sampling and comparing reference voltages.

Analog Meter—a multimeter with a needle pointer and a scale. Numerical values are estimated by comparing the pointer position to graduations on the scale. This differs from a digital meter which always displays exact values on a numerical readout.

Anode—the positive plate of an electrical device. Opposite from the cathode which is the negative plate.

Anode Well—a well-like receptacle on the CRT which receives the flyback transformer’s high voltage lead.

Aspect Ratio—the proportional appearance of text and graphics on a monitor as a function of horizontal and vertical resolution.

AWG—an acronym for American wire gauge. 18-AWG (stripped) wire is 40.3 mils thick. 20-AWG (stripped) wire is 31.96 mils thick. 22-AWG (stripped) wire is 25.35 mils thick. AWG does not consider insulation thickness, which varies from material to material. Most 512K to Mac Plus power supply harnesses are 20-AWG. Mac SE harnesses are 18-AWG.

Axial—an adjective derived from the word axis. Axial caps have leads out the side. The leads suggest an imaginary axle running through the center of a capacitor.

Bail—a wire tie-down used to keep cable connectors together. Easier to use than tiny screws and nuts.

Base—one of three electrical junctions on a transistor.

Blooming—a condition in which display size increases irregularly as you turn up the brightness. Like a flower unfolding.

Board—a shortened version of circuit board.

Board References—letter-number combinations like CR18 and CR19. Board references are used like street addresses to reference the occupants (OEM parts) which reside at referenced locations on a circuit board.

Bong!—refers to the sound the Macintosh normally makes on power-up.

Boxer Fan—a small, rotating fan with an integral box-like mounting frame. Standard equipment on the Macintosh SE. Can easily be added to other 9-inch Macs.

BP Capacitor—an abbreviation for bipolar (or bipolarized) capacitor. Same as an NP or a nonpolarized capacitor. Different from an electrolytic capacitor. Specifically, C1, a critical 3.9-mfd 25-V BP capacitor used in the horizontal deflection circuit of the Macintosh power supply.

BROYL—an acronym for brown red orange yellow green. These colors represent the numbers 1 through 5 in the resistor color code. This acronym is easy to remember because when resistors overheat, they really broil.

Buckling—a condition in which display linearity distorts as you turn up the brightness.

Burn In—occurs when the face of a CRT picks up a permanent image that looks like a (photographic) negative of the normal display. A problem with some used Lisa's and Macintosh XL's. Even when the computer is off, you can still see the menu bar.

Capacitor—an electronic component capable of storing an electric charge. Leaky capacitors are like drafty windows.

Carbon Film—a raw material from which resistors are made.

Card—a plug-in circuit board.

Card Cage—a removable holder for plug-in circuit boards. Found in Lisa's and Macintosh XL's.

Case Popper—a common-variety 1-inch spring clamp sold in hardware stores. Used to separate the front and rear halves of the outer cabinet.

Cathode—the negative plate of an electrical device. Opposite from the anode which is the positive plate.

Chassis—the metal frames of machines and electrical devices.

Circuit Board—a type of thin plastic full of holes connected by copper traces. The holes replace old-fashioned terminal strips. The copper traces eliminate the need for point-to-point wiring.

Clock Battery—on the 128K to Mac Plus, a 4.5-V alkaline battery located in a small compartment just above the power switch. On the Mac SE, a 3.0-V lithium battery soldered to the logic board. Clock batteries maintain the correct time and date and provide power to an area of memory where the volume setting and other Control Panel information is stored.

Closed—a shortened version of closed circuit. A closed circuit is said to be ON. Current flows normally at a controlled rate. Different from an open or a short circuit.

Collector—one of three electrical junctions on a transistor.

Color Code—a way to identify the value of small components. Each color represents a number.

Comfortable Setting—the brightness level which causes the least amount of eyestrain.

Complementary Colors—red, green, and blue are said to be complementary colors because when their light is mixed in equal proportions (as in a color monitor), white light is produced.

Continuity—refers to a closed or continuous circuit which allows the flow of electricity.

CPU—an acronym for central processing unit. In Lisas, Mac XL's, and all 9-inch Macs from the 128K to Macintosh SE, the CPU is a Motorola MC68000.

Crosshatch—a grid of regularly spaced squares used to align CRT's.

Crowbar Circuit—an overvoltage protection circuit designed to prevent fires by shutting down the power supply under potentially dangerous conditions.

CRT—an acronym for cathode ray tube. Same as a TV picture tube.

Current—refers to the flow of electricity in the same way that it refers to the flow of water.

Cut-off Adjustment—a coarse brightness control which affects horizontal blanking.

DB-9 Shell—the metal or plastic housing for a DB-9 connector.

DB-9M Connector—a DB-9 male connector has plugs or pins. Same as a DB-9P. Different from a DB-9 female connector which has holes or sockets.

DB-9F Connector—a DB-9 female connector has holes or sockets. Same as a DB-9S. Different from a DB-9 male connector which has plugs or pins.

DC—an acronym for direct current. Different from alternating current. In a DC power supply, alternating current is rectified and filtered so that the polarity of the output voltage never changes.

Digital—having to do with numbers and/or direct numerical readouts. Different from analog which has to do with pointers and analogous references to numbers.

Digital Board—refers to the logic board.

Digital Meter—a multimeter with a direct numerical readout.

DIP—an acronym for dual inline package. Refers to IC's with two (dual) lines of pins.

Discharge—a term describing what happens when capacitors and CRT's give up their electrical charge.

Display—generally, that which is displayed (or shown) on the screen (the illuminated area of the screen). Often used incorrectly to indicate the screen itself. If there's nothing on the screen, then the display is blank.

DPI—an acronym for dots-per-inch. 9-inch Macs display 72 dots-per-inch horizontally by 72 dots-per-inch vertically.

Drive Capacity—refers to the maximum storage capacity of the data disks which can be used in a disk drive.

ECG—an abbreviation for Philips ECG, a manufacturer of replacement semiconductors.

Electrolytic Capacitor—a capacitor with distinct positive and negative plates.

Emitter—one of three electrical junctions on a transistor.

Expansion Card—a circuit board designed to plug into an expansion slot.

Expansion Slot—an internal connector designed to accept expansion cards. Lisas and Mac XL's have three expansion slots. The Mac SE has one. 128K to Mac Plus computers have none.

FET—an acronym for field effect transistor.

FET Meter—a high-quality analog multimeter containing field effect transistors.

Flat-head Screwdriver—same as a slotted screwdriver.

Flup, Flup, Flup Noise—flapping occurs when SCR Q8 in the OVP (overvoltage protection) circuit "crowbars" the power supply in response to an overvoltage condition. The usual cause is a shorted rectifier or a failed electrolytic capacitor. Sometimes, the TSM chip on the logic board is at fault.

Flyback Transformer—the part which transforms low voltage into the high voltage needed to drive the CRT.

Foldover—describes a condition where the display folds back on itself, like bed covers which are folded back at night.

Fresnel Lens—a magnifying lens named after 19th century French physicist Augustin Jean Fresnel. Fresnel lenses look something like clear phonograph records.

Frequency Response—refers to volume as a function of frequency. Some frequencies reproduce much louder than others on a Macintosh. Adding a speaker grill to the side of the 128K to Mac Plus tends to smooth that out.

Gate—one of three electrical junctions on a silicon controlled rectifier.

Ghosting—an afterimage on the CRT which fades slowly enough to be seen.

GP—an acronym for general purpose.

Grid Blocks—refers to the squares in TPG's crosshatch test pattern.

Grounding Spiker—this part is about the size of a quarter and fits over a plastic fin on the left inside of the rear cover (128K to Mac Plus, only). The spider's function is to discharge static electricity through the ground trace on the power-supply board.

Half and Half Computers—128K to 512K computers which have received a Mac Plus logic board upgrade. Until the analog board is upgraded to Mac Plus specifications, they're still 50% 128K to 512K machines.

Heat Sink—a piece of metal used to conduct heat away from a heat-sensitive electronic device.

Heat Sink Grease—a special compound used to fill imperfections (air pockets) in the metal, which increases the thermal transfer between the transistor's mounting tab and the metal heat sink. Also known as Thermal Compound.

Hemostats—a forceps-like tool.

Hex Key—a hexagonal screwdriver.

HF Capacitor—an acronym for high-frequency capacitor.

HFS—an acronym for the hierarchical file system. Allows a root directory and a hierarchy of multiple subdirectories. Different from MFS, the original Macintosh file system, which allows only one directory.

Hot Border—clickable borders in TPG's circular test pattern.

H-Size—refers to the horizontal width control.

IC—an acronym for integrated circuit.

IC Puller—a special set of tongs used for removing ICs from their sockets. Often sold in combination with pin straighteners.

IDC—an acronym for insulation displacement connector, a solderless connector made for use with ribbon cable. Squeezing with a bench vise or a special hand tool displaces the insulation and makes the connection.

Inrush Current Limiter—a disc-shaped thermistor used in AC/DC switching power supplies. Protects against high peak inrush current. Rated in ohms, plus or minus 25 percent at 25 degrees Celsius. Specifically, R39, in the Macintosh power supply is an inrush current limiter rated 16 ohms, 4 amps.

International Analog Board—the international version of the 128K to Mac Plus analog board has a convertible 120/240-V power supply.

I/O Connector—an acronym for input/output connector. Refers to the mouse, disk drive, printer, modem, and audio connectors at the back of the logic board.

Jumper—a piece of wire used to short two connections.

LED—an acronym for light emitting diode. 400K Mac drives, most hard drives, and some external 800K drives use LED's for lights.

Linearity—linearity refers to the degree that squares actually look like squares and circles look like circles.

Logic Board—the digital board found in 128K to Macintosh SE computers. Also referred to as the mother board.

Mechanic's Ratchet—a tool for use with socket sets.

Metal Film Fixed Resistor—a 1/4-watt precision resistor. Very high grade. May be coated with light blue lacquer. Always has an extra color band. Rated in ohms, plus or minus 1 percent at 25 degrees Celsius, 65 percent relative humidity.

Metal Oxide Film Resistor—a 1-watt or 2-watt flameproof power resistor. High surge overload capability. Relatively small size. Rated in ohms, plus or minus 5 percent at 25 degrees Celsius.

MFS—an acronym for the original Macintosh file system. All files are kept in the root directory. Different from HFS (hierarchical file system), which allows subdirectories.

Microfarad—0.000001 farad.

Multitester—a meter which is capable of measuring at least voltage, current, and resistance.

Nanosecond—0.000000001 second.

Nichicon—a Japanese capacitor manufacturer. They make a 100-V replacement for C1, a critical 3.9-mfd, NP capacitor used in the horizontal deflection circuit of the Macintosh power supply.

NP Capacitor—an abbreviation for nonpolarized capacitor. Same as a BP or bipolarized capacitor. Different from an electrolytic capacitor. Specifically, C1, a critical 3.9-mfd, 25-V NP capacitor used in the horizontal deflection circuit of the Macintosh power supply.

OEM—an acronym for original equipment manufacturer. Sony is the OEM of 3.5-inch Macintosh drives. Samsung is an OEM of high-quality Macintosh CRT's.

Ohm—a unit of measurement for resistance.

Open—a shortened version of open circuit. Different from a closed circuit or a short circuit. When a circuit opens, the flow of electricity is stopped.

OS—an acronym for operating system, a fundamental set of instructions that all computers rely upon. No OS—no go! On the Macintosh, part of the OS is contained in the ROM chips and part is loaded in from the System software.

OVP—an acronym for overvoltage protection circuit.

Pad—a round copper reinforcement for holes in the circuit trace.

PC Board—a shortened version of printed-circuit board.

PC Mount—a component with solid wire-like leads that can be soldered to a PC board.

Philips—spelled with one l, refers to Philips, ECG, a manufacturer of replacement semiconductors.

Phillips—spelled with two l's, refers to a Phillips-head screwdriver.

Picofarad—0.000000000001 farad

Picture Tube—the large vacuum tube display used in televisions and computer monitors.

Piezoelectric Fan—a small fan which uses line frequency to flex twin mylar blades. The blades move back and forth like hand-held paper fans.

Pin Straightener—a gauge-like tool used to straighten bent pins on integrated circuits. Often sold in combination with IC pullers.

Pixel—luminous dots which make up the screen on a computer.

Pot—a shortened version of potentiometer. Also referred to as a trimmer or a variable resistor.

Printed Circuit—refers to the copper tracing on a circuit board.

Processor—a shortened version of central processing unit, which may also be abbreviated as CPU. In Lisas, Mac XLs, and all 9-inch Macs from the 128K to Macintosh SE, the processor is a Motorola MC68000.

Processor Clip—a device designed to clip onto the MC68000 processor. An integral part of some third party upgrades. Also known as a low profile logical connection.

Programmer's Switch—refers to a user installed button which mounts at the rear, lower left side of the Macintosh.

PROM—an acronym for programmable ROM.

Purity Tabs—magnetic rings on the neck of the CRT used to control screen centering.

Radial—derived from the word “radius.” Radial caps have two leads out the bottom, suggesting an origin at the center of the capacitor. Different from axial caps which have one lead at each end, suggesting a diameter.

RAM—an acronym for random access memory.

Raster—the part of the screen that lights up.

Resistor—a component which resists the flow of electricity.

Resolution—refers to the number of pixels across the screen and the number of pixels from top to bottom. Resolution on the standard 9-inch Macintosh is 512 (across) by 342 (top to bottom).

Reverse Video—refers to a physical switch or a menu item which changes all the black pixels to white and vice versa. 128K-TPG has a Reverse Video menu item. Some external monitors have a reverse video switch which affects all programs (not just TPG).

RFI—an acronym for radio frequency interference. The RFI shield is a thin piece of aluminum-colored material which covers the I/O connectors at the back of the Macintosh. It helps to keep the computer from interfering with radio/TV reception.

ROM—an acronym for read only memory.

Scan Lines—diagonal lines caused by the horizontal retrace. Get rid of them with the cut-off control.

Schematic—a circuit drawing.

Schottky Diode—a type of rectifier with low forward voltage drop and fast reverse recovery time, designed to meet the requirements of switching power supplies.

Screen—the face or front surface of the picture tube. Not the entire tube. Generally larger than the display.

Screen Dimmer—a program that automatically dims the screen after a predetermined interval of no user activity. Used to prevent burn in.

SCSI—pronounced “scuzzy,” an acronym for small computer systems interface. Standard equipment from the Mac Plus on up, the SCSI allows you to plug in high speed hard drives, laser printers, and scanners.

Semiconductor—a material with conductive properties halfway between a metal and an insulator.

Short—a shortened version of short circuit. Different from an open circuit. In a short circuit, electricity flows uncontrollably.

Shrunk Display—when the screen is out of adjustment, the display is said to be shrunken or stretched, though that’s not likely.

SIMM—an acronym for single inline memory module. SIMMs are standard equipment on all models from the Mac Plus on up. The logic board is equipped with SIMM sockets. RAM chips are indirectly soldered to detachable plug-in modules instead of directly soldered to the logic board. Note that it's incorrect to say "SIMMs modules." That's like saying single inline memory module module!

SIP—an acronym for single inline package. Refers to IC's and other parts with one (a single) line of pins.

Slotted Screwdriver—same as a flat-head screwdriver.

Slug—the powdered iron core of a tunable coil. L2, the Macintosh width adjustment has a slug.

SMD—an acronym for surface mount device. Tiny leads extending from all four sides of the part are tightly curled to save room.

Sound—the auditory perception of vibrations. If there's no one around to hear a noise, there's no sound!

SPDT—an acronym for single pole double throw, a type of two-way switch.

Spring Clamp—a common woodworking tool otherwise known as a Macintosh case popper.

Stabilant—a chemical which fills crevices in metal, maximizing metal-to-metal contact, and making it more difficult for corrosion to set in.

Sweep—a left-to-right motion. Alternately, a top-to-bottom motion.

Template—a pattern which serves as a gauge or a guide in mechanical work. 512K-TPG contains a template for drilling a speaker grill into the side of a 128K to Macintosh Plus cabinet.

Test Pattern Generator—(TPG) the comprehensive diagnostics program included with this book.

Test Tone Oscillator—(TTO) TPG's integrated audio program.

Thermal Compound—same as heat sink grease.

Thermal Resistance—the ability to conduct heat. The lower the resistance, the more heat is conducted.

Thermistor—a thermally sensitive resistor made of polycrystalline ceramic materials. Resistance varies as a function of temperature.

Tie Wraps—insulated nylon ties used for wrapping wires together.

TO-220—refers to a particular style of transistor case.

Torque—the product of force times lever arm.

TPG—an acronym for Test Pattern Generator, the comprehensive diagnostics program included with this book.

Trace—same as a circuit trace.

T-square—a tool consisting of perpendicular rulers.

TTL—an acronym for transistor transistor logic.

TTO—an acronym for Test Tone Oscillator, TPG's integrated audio test program.

Transistor—a miniature component which has completely replaced vacuum tubes in electronic equipment.

Trimmer Pot—a variable potentiometer.

U.S. Analog Board—the U.S. version of the 128K to Mac Plus analog board has a 120-V power supply.

Vinyl Jacket—an insulating jacket for the analog board.

Voltage—refers to electrical pressure. Used in the same sense as water pressure.

VOM—an acronym for volt ohmmeter. Generally refers to inexpensive pocket meters.

V-Size—refers to a monitor's vertical size control.

Wirewound Resistor—a resistor made from turns of wire.

WVDC—an acronym for Working Volts DC.

Yoke—a wiring harness mounted around the neck of the CRT. Contains big electromagnets used to control the horizontal and vertical sweep.

Zener Diode—a type of diode used to maintain a specified voltage. The operating range of a zener diode is plus or minus 10 percent.

APPENDIX

B

Dealer/Manufacturer Addresses

Altex Electronics

(2-pin shorting blocks, 4-position/
4-contact handset plug crimpers, 4-
position/4-contact handset plugs,
IDC connectors, mini DIN 8 plugs)
300 Breesport
San Antonio, Texas 78216
(800) 531-5369

Central Products

(Macintosh take-apart tools)
2211 Norfolk, Suite 518
Houston, Texas 77098
(713) 529-1080

Computer Service Experts

(amber, green, and OEM CRT's)
3484 The Alameda
Santa Clara, California 95050
(408) 984-5091

Dafax Processing Corp.

(Lisa/Mac XL parts and upgrades,
Lisa/Mac XL sound cards)
14 North Drive
Malba, New York 11357
(800) 323-1751

Digi-Key

(2 3/8-inch 12-V DC boxer fans, 3.9-
mfd 100-V DC NP metalized
polyester caps, 4-position/4-
contact handset plugs, HF
Panasonic caps, microswitches,
SIMM sockets—call for a catalog)
701 Brooks Avenue South
Post Office Box 677
Thief River Falls, Minnesota 56701-
0677
(800) 344-4539

Dove Computer Corporation

(Install-it-yourself SCSI upgrades
for the 512Ke, install-it-yourself
SIMM upgrades for the Macintosh
Plus, Macintosh take-apart tools—
call for nearest dealer)
1200 North 23rd Street
Wilmington, North Carolina 28405
(800) 622-7627

Edmund Scientific

(2 3/8-inch 12-V DC boxer fans, 120/240-V AC piezoelectric fans—call for a catalog)

101 East Gloucester Pike
Barrington, New Jersey 08007-1380
(609) 573-6250

Howard W. Sams & Co.

(*Microcomputer Troubleshooting & Repair* computer books, and basic electronics/repair books)

Post Office Box 775
Carmel, Indiana 46032

Jacques Ebert Associates

(2 3/8-inch 12-V DC boxer fans, 3.9-mfd NP 100-V HF radial caps, 4-mfd NP 25-V HF axial caps—call for nearest dealer)

44 School Street
Glen Cove, New York 11542
(800) 645-2666

Jameco Electronics

(41-256 RAM chips, handset cables, miscellaneous OEM parts, replacement mice, soldering equipment, 8-pin DIP 220/330 dual terminators, test equipment—call for a catalog)

1355 Shoreway Road
Belmont, California 94002
(415) 592-8097

JDR Microdevices

(DB19 connectors, miscellaneous OEM parts, soldering equipment, test equipment—call for a catalog)

2233 Branham Lane
San Jose, California 95124
(408) 559-1200

MCM Electronics

(41-256 RAM chips, 4-position/4-contact handset plug crimpers, 4-position/4-contact handset plugs, handset cables, flyback transformers, miscellaneous OEM parts, soldering equipment, test equipment—call for a catalog)

650 East Congress Park Drive
Centerville, Ohio 45459-4072
(800) 543-4330

MicroSolutions

(400/800K Mac disk-drive controller cards for XT and AT compatible computers)

132 West Lincoln Highway
DeKalb, Illinois 60115
(815) 756-3411

MicroStore

(Teflon surfaced mouse feet)

Post Office Box 33
LeSueur, Minnesota 56058
(800) 962-8885

Micro Systems Design

(Lisa/Mac XL schematics)

Post Office Box 1187
Loomis, California 95650
(916) 652-5665

Mobius Technologies, Incorporated

(MultiScreen video card for the Macintosh SE, Multiscanning monitors for the Lisa/ Mac XL and the Macintosh SE)

6020 Adeline Street
Oakland, California 94608
(415) 654-0556

Philips ECG

(Replacement semiconductors—call for nearest dealer)

1025 Westminster Drive
Post Office Box 3277
Williamsport, Pennsylvania 17701
(717) 323-4691

Radio Shack

(Microswitches, miscellaneous OEM parts, soldering equipment, test equipment)
over 700 stores coast to coast listed in the phone book under: "Electronic Equipment & Supplies"

R&D Electronic Surplus

(Nickel-cadmium batteries, surplus keyboard assemblies—call for a catalog)
1224 Prospect Avenue
Cleveland, Ohio 44115
(216) 621-1121

Sears Roebuck and Co.

(#1 screwdrivers, 1-inch spring clamps, WD-40)
hundreds of stores coast to coast listed in the phone book under: "Sears Roebuck and Co"

Sher-Mark Products Inc.

(Antiglare magnification screens)
521 East 83rd Street—Suite 2R
New York, New York 10028
(800) 323-1776 Extension 71

Shreve Systems

(Analog boards, disk drives, logic boards, OEM memory upgrades, ROM chips, used parts)
2421 Malcolm Street
Shreveport, Louisiana 71108
(318) 635-1121

Soft Solutions

(2 3/8-inch 120-V AC boxer fans, 3.9-mfd NP 100-V HF radial caps, 18-gauge power supply harnesses, BU-406 transistors, component level repairs, flyback transformers, heavy-duty power supply upgrade kits, J1 connectors, L2 coils, Macintosh schematics, OEM power supply components, stabilant chemical for electrical connectors)
907 River Road, Suite 98
Eugene, Oregon 97404
(503) 461-1136

Sophisticated Circuits

(41-256 RAM chips, do-it-yourself 128K to 512K memory upgrade kits, do-it-yourself 512K to 2048K memory upgrade kits, install-it-yourself SCSI upgrades for the 512Ke, install-it-yourself SIMM upgrades for the Mac Plus and the Mac SE)
19017 120th Avenue North East, Suite 106
Bothell, Washington 98011
(206) 547-4779

Sun Remarketing

(Lisa/Mac XL parts and upgrades—call for a catalog)
Post Office Box 4059
Logan, Utah 84321
(800) 821-3221

Systems Control, a Division of M.J. Electric

(Dual-outlet surge suppressor with integral antistatic touch pad)
Post Office Box 788E
Iron Mountain, Michigan 49801
(800) 451-6866

Technology Works

(Do-it-yourself internal and external hard drive kits, OEM hard drives, SIMM upgrades for the Mac Plus and the Mac SE)
4030 Braker Lane West, Suite 350
Austin, Texas 78759
(800) 622-2210

True Value Hardware

(1/4-inch ratchet sets, 1/4-inch T-15 insert bits, 3/8-inch outside diameter 1/4-inch bit holders, 1-inch spring clamps, WD-40)
Hundreds of stores coast to coast listed in the phone book under: "Hardware-Retail"

Larry P.'s Guide to Mail-order Sanity:

1. If there's no address and/or no phone number in a magazine advertisement, it means the company positively does not want to talk to you. Don't waste your time. Shop elsewhere!
2. Avoid ordering from any catalog with a misplaced index. Locating misplaced indexes is a hassle. If management misplaced their own index, imagine what they're going to do with your order!
3. Avoid ordering from any catalog printed on high glare paper. If the printed presentation glares, you can bet the personal service will glare even more.
4. Don't discuss. Don't ask. Know what you want before you pick up the phone.
5. Observing these failure avoidance strategies will steer you away from incompetent mail-order firms, but you could still receive unsatisfactory goods. In that case, please call the company that filled your order. This address list is not an endorsement. The author cannot guarantee your satisfaction.

APPENDIX



Parts List—Macintosh Analog Board—U.S. Version

CAPACTORS

Ref.	Cap.	WV	WTemp.	Type	OEM
C1	3.9 mfd	25 V	85 °C	HF NP AL radial	Nippon Chemi-con
or	3.9 mfd	35 V	85 °C	HF NP AL radial	Nippon Chemi-con
ok	4.0 mfd	25 V	85 °C	HF NP AL axial	Nichicon
ok	3.9 mfd	100 V	85 °C	HF NP AL radial	Nichicon
ok	3.9 mfd	100 V	85 °C	Metallized polyester	Panasonic
ok	3.9 mfd	250 V	85 °C	Metallized polyester	Nichicon
ok	3.9 mfd	250 V	85 °C	HF metallized polypropylene	Nichicon
C2	4700 mfd	16 V	85 °C	Electro AL radial	Nippon Chemi-con
C3	220 mfd	16 V	105 °C	Electro AL radial	Nippon Chemi-con
ok	220 mfd	16 V	105 °C	HF electro AL radial	Panasonic
C4	.033 mfd	400 V		Metallized film	Panasonic
C5	47 mfd	10 V	85 °C	Electro AL axial	Nippon Chemi-con
C6	22 mfd	50 V	85 °C	Electro AL axial	Unspecified
C7	.01 mfd	1 kV		Ceramic disk	Unspecified
C8	.01 mfd	1 kV		Ceramic disk	Unspecified
C9	10 mfd	160 V	85 °C	Electro AL axial	Panasonic
C10	.22 mfd	100 V		Metallized polyester	Unspecified
C11	33 mfd	16 V	85 °C	Electro AL radial	Nippon Chemi-con
ok	33 mfd	16 V	105 °C	HF electro AL radial	Panasonic
C12	.01 mfd	400 V		Metallized polyester	Panasonic

CAPACITORS (cont.)

Ref.	Cap.	WV	WTemp.	Type	OEM
C13	33 mfd	16 V	85 °C	Electro AL radial	Nippon Chemi-con
ok	33 mfd	16 V	105 °C	HF electro AL radial	Panasonic
C14	22 mfd	50 V	85 °C	Electro AL radial	Unspecified
C15	.01 mfd	1.5 kV		Ceramic disk	Unspecified
C16	.01 mfd	1.5 kV		Ceramic disk	Unspecified
C17	.01 mfd	1.5 kV		Ceramic disk	Unspecified
C18	.1 mfd			Encapsulated ceramic	Unspecified
C19	.01 mfd	400 V		Metallized polyester	Panasonic
C20	.01 mfd	400 V		Metallized polyester	Panasonic
C21	.1 mfd			Mctal film	Unspecified
C22	.1 mfd			Encapsulated ceramic	Unspecified
C23	.1 mfd			Encapsulated ceramic	Unspecified
C24	2200 mfd	10 V	85 °C	Electro AL radial	Nippon Chemi-con
or	2200 mfd	16 V	85 °C	Electro AL radial	Nippon Chemi-con
ok	2200 mfd	16 V	105 °C	HF electro AL radial	Panasonic
C25	1000 mfd	16 V	105 °C	Electro AL radial	Samyoung
or	1000 mfd	16 V	105 °C	HF electro AL radial	Panasonic
ok	1000 mfd	25 V	105 °C	HF electro AL radial	Panasonic
C26	1000 mfd	16 V	105 °C	Electro AL radial	Samyoung
or	1000 mfd	16 V	105 °C	HF electro AL radial	Panasonic
ok	1000 mfd	25 V	105 °C	HF electro AL radial	Panasonic
C27	.022 mfd	400 V		Polyester	Unspecified
C28	.1 mfd			Encapsulated ceramic	Unspecified
C29	2200 mfd	10 V	105 °C	Electro AL radial	Nippon Chemi-con
or	2200 mfd	16 V	105 °C	HF electro AL radial	Panasonic
C30	220 mfd	16 V	105 °C	Electro AL radial	Nippon Chemi-con
ok	220 mfd	16 V	105 °C	HF electro AL radial	Panasonic
C31	1000 mfd	16 V	105 °C	Electro AL radial	Samyoung
or	1000 mfd	16 V	105 °C	HF electro AL radial	Panasonic
ok	1000 mfd	25 V	105 °C	HF electro AL radial	Panasonic
C32	.47 mfd	400 V		Polyester	Unspecified
C33	4700 pf	250 V		Molded minibox	Rifa
C34	330 pf	1 kV		Ceramic disk	Unspecified
C35	100 mfd	200 V	85 °C	Electro AL radial	Panasonic
C36	100 mfd	200 V	85 °C	Electro AL radial	Panasonic
C37	4700 pf	250 V		Molded minibox	Rifa
C38	.1 mfd	250 V		Molded minibox	Rifa
C39	470 mfd	10 V	85 °C	Electro AL radial	Nippon Chemi-con
C40	.03 mfd	400 V		Ceramic	Panasonic
C41	.01 mfd	400 V		Metallized polyester	Panasonic
C42	.1 mfd			Metallized film	Unspecified
C43	470 mfd	10 V	85 °C	Electro AL radial	Nippon Chemi-con

INDUCTORS

Ref.	Color Code	Tol.	Henrys	Size	Type
L4	Red Violet Black, Silver	10%	27 uh	½ W	Epoxy coat
L5	Red Violet Black, Silver	10%	27 uh	½ W	Epoxy coat

RESISTORS

Ref.	Color Code	Tol.	Ohms	Size	Type
R1	Red Red Brown, Gold	5%	220	¼ W	Carbon film
R2	Brown Green Gold, Gold	5%	1.5	¼ W	Carbon film
R3	Brown Green Gold, Gold	5%	1.5	¼ W	Carbon film
R4	Brown Black Brown, Gold	5%	100	¼ W	Carbon film
R5	Yellow Violet Yellow, Gold	5%	470 kΩ	¼ W	Carbon film
R6	Red Red Red, Gold	5%	2.2 kΩ	¼ W	Carbon film
or	Yellow Violet Red, Gold	5%	4.7 kΩ	¼ W	Carbon film
R7	N/A—no color code	10%	39	5 W	Wirewound
R8	Brown Black Brown, Gold	5%	100	¼ W	Carbon film
R9	Brown Black Green, Gold	5%	1 MΩ	½ W	Carbon film
R10	Brown Black Orange, Gold	5%	10 kΩ	¼ W	Carbon film
R11	Brown Green Gold, Gold	5%	1.5	¼ W	Carbon film
R12	Brown Black Brown, Gold	5%	100	¼ W	Carbon film
R13	Brown Black Yellow, Gold	5%	100 kΩ	½ W	Carbon film
R14	Brown Black Red, Gold	5%	1 kΩ	2 W	Metal-Oxide
R15	Brown Black Yellow, Gold	5%	100 kΩ	½ W	Carbon film
R16	Brown Black Yellow, Gold	5%	100 kΩ	½ W	Carbon film
R17	Brown Black Green, Gold	5%	1 MΩ	½ W	Carbon film
R18	Brown Black Yellow, Gold	5%	100 kΩ	½ W	Carbon film
R19	Yellow Violet Yellow, Gold	5%	470 kΩ	¼ W	Carbon film
R20	Red Red Brown, Gold	5%	220	¼ W	Carbon film
R21	Brown Black Red, Gold	5%	1 kΩ	¼ W	Carbon film
R22	Orange Orange Yellow, Gold	5%	330 kΩ	¼ W	Carbon film
R23	Yellow Violet Brown, Gold	5%	470	¼ W	Carbon film
R24	Brown Black Orange, Gold	5%	10 kΩ	¼ W	Carbon film
R25	Yellow Violet Brown, Gold	5%	470	¼ W	Carbon film
R26	Yellow Violet Brown, Gold	5%	470	¼ W	Carbon film
R27	Red Red Brown, Gold	5%	220	¼ W	Carbon film
R28	Brown Black Orange, Gold	5%	10 kΩ	¼ W	Carbon film
R29	Brown Black Green, Gold	5%	1 MΩ	¼ W	Carbon film
R30	Brown Black Orange, Gold	5%	10 kΩ	¼ W	Carbon film

RESISTORS (cont.)

Ref.	Color Code	Tol.	Ohms	Size	Type
R31	Brown Black Orange, Gold	5%	10 k Ω	1/4 W	Carbon film
R32	Brown Red Black, Gold	5%	12	1/4 W	Carbon film
R33	Brown Green Black, Gold	5%	15	1/4 W	Carbon film
R34	Brown Black Red, Gold	5%	1 k Ω	1/4 W	Carbon film
R35	Brown Black Red, Brown	1%	1 k Ω	1/4 W	Metal film
or	Brown Black Black Brown, Brown	1%	1 k Ω	1/4 W	Metal film
R36	Yellow Violet Brown, Gold	5%	470	1/4 W	Carbon film
R37	Brown Black Orange, Gold	5%	10 k Ω	1/4 W	Carbon film
R38	Brown Red Red, Brown	1%	1.2 k Ω	1/4 W	Metal film
or	Brown Red Black Brown, Brown	1%	1.2 k Ω	1/4 W	Metal film
R39	N/A—no color code	25%	16	4A-ICL	Thermistor
R40	Red Red Brown, Gold	5%	220	1/2 W	Carbon film
R41	Brown Black Yellow, Gold	5%	100 k Ω	1/2 W	Carbon film
R42	Brown Black Red, Brown	1%	1 k Ω	1/4 W	Metal film
or	Brown Black Black Brown, Brown	1%	1 k Ω	1/4 W	Metal film
R43	N/A—there is no R43!				
R44	Brown Black Brown, Gold	5%	100	1/4 W	Carbon film
R45	Brown Black Red, Gold	5%	1 k Ω	1/4 W	Carbon film
R46	Red Red Black, Gold	5%	22	1 W	Metal oxide
R47	Brown Green Gold, Gold	5%	1.5	1/4 W	Carbon film
R48	Brown Black Brown, Gold	5%	100	1/4 W	Carbon film
R49	Brown Green Gold, Gold	5%	1.5	1/4 W	Carbon film
R50	Brown Green Gold, Gold	5%	1.5	1/4 W	Carbon film
R51	Brown Green Black, Gold	5%	15	1/4 W	Carbon film
R52	Brown Black Orange, Gold	5%	10 k Ω	1/4 W	Carbon film
R53	N/A—no color code		2 M Ω		Cut-off pot
R54	N/A—no color code		2 M Ω		Focus pot
R55	N/A—no color code		500 k Ω		Height pot
R56	N/A—no color code		500		Voltage pot
R57	N/A—no color code		1 M Ω		Bright pot
R58	Brown Black Brown, Gold	5%	100	1/4 W	Carbon film
R59	Yellow Violet Gold, Gold	5%	4.7	1/4 W	Carbon film
R60	Brown Black Red, Gold	5%	1 k Ω	1/4 W	Carbon film

SEMICONDUCTORS

Ref.	OEM	Philips	Radio Shack	Description
CR1	GI 854	ECG 580	No listing	R-Si,600 V,3 A
ok	MR 824	No listing	No listing	R-Si,150 ns,400 V,5 A
CR2	1N 4150	ECG 519	276-1122	D-Si,4 ns,100 V
CR3	1N 4150	ECG 519	276-1122	D-Si,4 ns,100 V
CR4	1N 4150	ECG 519	276-1122	D-Si,4 ns,100 V
CR5	GI 854	ECG 580	No listing	R-Si,600 V,3 A
ok	MR 824	No listing	No listing	R-Si,150 ns,400 V,5 A
CR6	1N 4150	ECG 519	276-1122	D-Si,4 ns,100 V
CR7	1N 4150	ECG 519	276-1122	D-Si,4 ns,100 V
CR8	1N 4001	ECG 116	276-1101	R-Si,600 V,1 A
CR9	1N 4007	ECG 125	276-1114	R-Si,1000 V,2.5 A
CR10	1N 4937	ECG 552	276-1104	R-Si,600 V,1 A
CR11	RGPO1-12	No listing	No listing	
CR12	1N 4150	ECG 519	276-1122	D-Si,4 ns,100 V
CR13	1N 4150	ECG 519	276-1122	D-Si,4 ns,100 V
CR14	1N 4150	ECG 519	276-1122	D-Si,4 ns,100 V
CR15	1N 5234B	ECG 5013A	276-561	ZD,6.2 V,½ W
CR16	1N 4001	ECG 116	276-1101	R-Si,600 V,1 A
CR17	1N 4001	ECG 116	276-1101	R-Si,600 V,1 A
CR18	1N 5927	ECG 5127A	No listing	ZD,12 V,5 W
ok	1N 5349B	ECG 5127A	No listing	ZD,12 V,5 W
CR19	1N 5234B	ECG 5013A	276-561	ZD,6.2 V,½ W
CR20	31DQ	ECG 586	No listing	R-SchtkyBarrier,40 V,6 A
or	MBR 1035	No listing	No listing	R-SchtkyBarrier,35 V,10 A
ok	MBR 1045	No listing	No listing	R-SchtkyBarrier,45 V,10 A
CR21	31DQ	ECG 586	No listing	R-SchtkyBarrier,40 V,6 A
ok	MBR 1045	No listing	No listing	R-SchtkyBarrier,45 V,10 A
CR22	1N 4934	ECG 552	276-1104	R-Si,600 V,1 A
CR23	1N 4007	ECG 125	276-1114	R-Si,1000 V,2.5 A
CR24	1N 4007	ECG 125	276-1114	R-Si,1000 V,2.5 A
CR25	1N 4007	ECG 125	276-1114	R-Si,1000 V,2.5 A
CR26	1N 4007	ECG 125	276-1114	R-Si,1000 V,2.5 A
CR27	1N 4937	ECG 552	276-1104	R-Si,600 V,1 A
CR28	1N 4934	ECG 552	276-1104	R-Si,600 V,1 A
CR29	1N 4934	ECG 552	276-1104	R-Si,600 V,1 A
CR30	1N 4007	ECG 125	276-1114	R-Si,1000 V,2.5 A
Q1	MPS U01	ECG 188	No listing	T-NPN,2 A,10 W,TO-202N
Q2	MPS U51	ECG 189	No listing	T-PNP,2 A,10 W,TO-202N
Q3	BU 406	ECG 379*	No listing	T-NPN,7 A,60 W,TO-220

SEMICONDUCTORS (cont.)

Ref.	OEM	Philips	Radio Shack	Description
Q4	2N 4401	ECG 123AP	276-2058	T-NPN,.6 A,.5 W,TO-92
Q5	2N 5485	ECG 451	276-2062	JFET-N,Si,TO-92
Q6	2N 4401	ECG 123AP	276-2058	T-NPN,.6 A,.5 W,TO-92
Q7	2N 3904	ECG 123AP	276-2009	T-NPN,.6 A,.5 W,TO-92
Q8	2N 6394	ECG 5550	No listing	SCR,50 V,25 A,TO-220
or	S1010BH	ECG 5463	No listing	SCR,200 V RM,10 A,TO-220
Q9	2N 3906	ECG 159	276-1604	T-PNP,1 A,.6 W,TO-92
or	2N 4403	ECG 159	276-2023	T-PNP,1 A,.6 W,TO-92
Q10	EO 122	No listing	No listing	
or	EO 121	No listing	No listing	
or	EO 102	No listing	No listing	
or	SD 8335	No listing	No listing	
or	CR 400Y	ECG 5589	No listing	SCR,1200 V,550 A
Q11	2SC 2827	ECG 379	No listing	T-NPN,12 A,100 W,TO-220
or	2SC 2810	ECG 379	No listing	T-NPN,12 A,100 W,TO-220
or	2SC 3039	ECG 379	No listing	T-NPN,12 A,100 W,TO-220
U1	LM 324N	ECG 987	276-1711	IC,14-p,LP quad op amp
U2	SN74LS38N	ECG 74LS38	No listing	IC,14-p,quad 2-input NAND
U3	4N35	ECG 3041	No listing	IC,6-p,optoisolator,2500 V

*ECG 379 is not recommended in this application—causes severe horizontal foldover at the left side of the screen. Use original equipment BU 406 whenever possible. If OEM BU 406 is unavailable, substitute RCA SK 9085, instead.

MISCELLANEOUS

Ref.	OEM	Part #	Description
B1	Eveready	523	4.5-V battery
ok	Ray-O-Vac	RPX21	4.5-V battery
CRT	Clinton Taiwan Corp.	--8GHZYB	9-inch white CRT
or	Samsung	Type 10ATY4N	White antiglare CRT
ok	Orion	R51361331-SDH	Green antiglare CRT
F1	Unspecified	Unspecified	2.5 A 250 V fuse
ok	Radio Shack	270-1245	5x20 mm 2.5 A 250 V
NE1	Unspecified	Unspecified	Neon lamp
ok	Radio Shack	272-1102	NE-2H neon lamp
NE2	Unspecified	Unspecified	Neon lamp
ok	Radio Shack	272-1102	NE-2H neon lamp
T1	Taiwan Totoku Electric Co.	157-0026-B	Flyback (128/512)
or	ZFAT	AC-058	Flyback (128/512)
or	Tai-Ho/Taiwan R.O.C.	TH-1565	Flyback (512/Plus)
or	Monitron/Taiwan R.O.C.	157-0026-B	Flyback (Plus)
ok	Tai-Ho/Taiwan R.O.C.	TH-1565C	Bleeder-type flyback
ok	Monitron/Taiwan R.O.C.	157-0026-C	Bleeder-type flyback
ok	Lifon/Taiwan R.O.C.	157-0042-B	Bleeder-type flyback
T3	Astec	157-0025-A	Power transformer

APPENDIX



Parts List—Macintosh Analog Board— International Version

CAPACITORS

Ref.	Cap.	WV	WTemp.	Type	OEM
C1	3.9 mfd	25 V	85 °C	HF NP AL radial	Nippon Chemi-con
or	3.9 mfd	35 V	85 °C	HF NP AL radial	Nippon Chemi-con
ok	4.0 mfd	25 V	85 °C	HF NP AL axial	Nichicon
ok	3.9 mfd	100 V	85 °C	HF NP AL radial	Nichicon
ok	3.9 mfd	100 V	85 °C	Metallized polyester	Panasonic
ok	3.9 mfd	250 V	85 °C	Metallized polyester	Nichicon
ok	3.9 mfd	250 V	85 °C	HF metallized polypropylene	Nichicon
C2	4700 mfd	16 V	85 °C	Electro AL radial	Nippon Chemi-con
C3	220 mfd	16 V	105 °C	Electro AL radial	Nippon Chemi-con
ok	220 mfd	16 V	105 °C	HF electro AL radial	Panasonic
C4	.033 mfd	400 V		Metallized film	Panasonic
C5	47 mfd	10 V	85 °C	Electro AL axial	Nippon Chemi-con
C6	22 mfd	50 V	85 °C	Electro AL axial	Nippon Chemi-con
C7	.01 mfd	1 kV		Ceramic disk	Unspecified
C8	.01 mfd	1 kV		Ceramic disk	Unspecified
C9	.22 mfd	100 V		Metallized polyester	Panasonic
C10	33 mfd	16 V	85 °C	Electro AL radial	Unspecified
ok	33 mfd	16 V	105 °C	HF electro AL Radial	Panasonic
C11	10 mfd	160 V	85 °C	Electro AL radial	Richey
C12	22 mfd	50 V	85 °C	Electro AL axial	Nippon Chemi-con

CAPACITORS (cont.)

Ref.	Cap.	WV	WTemp.	Type	OEM
C13	.01 mfd	1.5 kV		Ceramic disk	Unspecified
C14	.01 mfd	1.5 kV		Ceramic disk	Unspecified
C15	.01 mfd	1.5 kV		Ceramic disk	Unspecified
C16	.01 mfd	400 V		Metallized film	Panasonic
C17	.01 mfd	400 V		Metallized film	Panasonic
C18	33 mfd	16 V	85 °C	Electro AL axial	Unspecified
C19	.1 mfd			Encapsulated ceramic	Unspecified
C20	.1 mfd			Encapsulated ceramic	unspecified
C21	.01 mfd	400 V		Metallized film	Panasonic
C22	.1 mfd	100 V		Metallized film	Panasonic
C23	.1 mfd			Encapsulated ceramic	Unspecified
C24	2200 mfd	16 V	105 °C	Electro AL radial	Nippon Chemi-con
ok	2200 mfd	16 V	105 °C	HF electro AL radial	Panasonic
C25	.022 mfd	400 V		Metallized film	Unspecified
C26	.1 mfd			Encapsulated ceramic	Unspecified
C27	2200 mfd	10 V	105 °C	Electro AL radial	Nippon Chemi-con
ok	2200 mfd	16 V	105 °C	HF electro AL radial	Panasonic
C28	1000 mfd	16 V	105 °C	HF electro AL radial	Panasonic
ok	1000 mfd	25 V	105 °C	HF electro AL radial	Panasonic
C29	.47 mfd	400 V		Metallized film	Unspecified
C30	2200 mfd	10 V	105 °C	Electro AL radial	Nippon Chemi-con
ok	2200 mfd	16 V	105 °C	HF electro AL radial	Panasonic
C31	220 mfd	16 V	105 °C	Electro AL radial	Unspecified
ok	220 mfd	16 V	105 °C	HF electro AL radial	Panasonic
C32	2200 mfd	16 V	105 °C	Electro AL radial	Nippon Chemi-con
ok	2200 mfd	16 V	105 °C	HF electro AL radial	Panasonic
C33	4700 pf	250 V		Molded minibox	Rifa
C34	100 mfd	200 V	85 °C	Electro AL radial	Panasonic
C35	100 mfd	200 V	85 °C	Electro AL radial	Panasonic
C36	4700 pf	250fV		Molded minibox	Rifa
C37	.47 mfd	250 V		Molded minibox	Rifa
C38	100 mfd	200 V	85 °C	Electro AL radial	Panasonic
C39	100 mfd	200 V	85 °C	Electro AL radial	Panasonic
C40	33 pf	1 kV		Ceramic disk	Unspecified
C41	.1 mfd	100 V		Metallized film	Unspecified
C42	470 mfd	10 V	85 °C	Electro AL radial	Ritchey
C43	.01 mfd	400 V		Metallized film	Panasonic
C44	.01 mfd	1 kV		Ceramic disk	Unspecified
C45	470 mfd	10 V	85 °C	Electro AL radial	Ritchey

RESISTORS

Ref.	Color Code	Tol.	Ohms	Size	Type
R1	Red Red Brown, Gold	5%	220	1/4 W	Carbon film
R2	Brown Green Gold, Gold	5%	1.5	1/4 W	Carbon film
R3	Brown Green Gold, Gold	5%	1.5	1/4 W	Carbon film
R4	Brown Black Brown, Gold	5%	100	1/4 W	Carbon film
R5	Yellow Violet Yellow, Gold	5%	470 k Ω	1/4 W	Carbon film
R6	Red Red Red, Gold	5%	2.2 k Ω	1/4 W	Carbon film
R7	Brown Black Brown, Gold	5%	100	1/4 W	Carbon film
R8	Brown Black Orange, Gold	5%	10 k Ω	1/4 W	Carbon film
R9	Brown Green Gold, Gold	5%	2.5	1/4 W	Carbon film
R10	N/A—no color code	10%	39	5 W	Wirewound
R11	Brown Black Brown, Gold	5%	100	1/4 W	Carbon film
R12	Brown Black Green, Gold	5%	1 M Ω	1/2 W	Carbon film
R13	Brown Black Yellow, Gold	5%	100 k Ω	1/2 W	Carbon film
R14	Brown Black Red, Gold	5%	1 k Ω	1/4 W	Carbon film
R15	Orange Orange Yellow, Gold	5%	330 k Ω	1/4 W	Carbon film
R16	Yellow Violet Brown, Gold	5%	470	1/4 W	Carbon film
R17	Brown Black Orange, Gold	5%	10 k Ω	1/4 W	Carbon film
R18	Brown Black Brown, Gold	5%	100	1/4 W	Carbon film
R19	Brown Black Yellow, Gold	5%	100 k Ω	1/2 W	Carbon film
R20	Brown Black Yellow, Gold	5%	100 k Ω	1/2 W	Carbon film
R21	Brown Black Green, Gold	5%	1 M Ω	1/2 W	Carbon film
R22	Brown Black Yellow, Gold	5%	100 k Ω	1/2 W	Carbon film
R23	Yellow Violet Yellow, Gold	5%	470 k Ω	1/4 W	Carbon film
R24	Red Red Brown, Gold	5%	220	1/4 W	Carbon film
R25	Brown Black Orange, Gold	5%	10 k Ω	1/4 W	Carbon film
R26	Brown Black Green, Gold	5%	1 M Ω	1/4 W	Carbon film
R27	Brown Black Orange, Gold	5%	10 k Ω	1/4 W	Carbon film
R28	Brown Black Orange, Gold	5%	10 k Ω	1/4 W	Carbon film
R29	Yellow Violet Brown, Gold	5%	470	1/4 W	Carbon film
R30	Yellow Violet Brown, Gold	5%	470	1/4 W	Carbon film
R31	Brown Black Red, Gold	5%	1 k Ω	2 W	Metal oxide
R32	Red Red Brown, Gold	5%	220	1/4 W	Carbon film
R33	Brown Black Red, Gold	5%	1 k Ω	1/4 W	Carbon film
R34	Brown Black Red, Gold	5%	1 k Ω	1/4 W	Carbon film
R35	Brown Black Red, Brown	1%	1 k Ω	1/4 W	Metal film
R36	N/A—no color code	25%	16	4A-ICL	Thermistor
R37	Orange White Brown, Gold	5%	390	1/4 W	Carbon film
R38	Brown Black Orange, Brown	5%	10 k Ω	1/4 W	Metal film
R39	Brown Red Red, Brown	1%	1.2 k Ω	1/4 W	Metal film
R40	Yellow Violet Black, Gold	5%	470	1/4 W	Carbon film

RESISTORS (cont.)

Ref.	Color Code	Tol.	Ohms	Size	Type
R41	Brown Black Brown, Gold	5%	100	¼ W	Carbon film
R42	Brown Black Red, Gold	5%	1 kΩ	¼ W	Carbon film
R43	Brown Black Yellow, Gold	5%	100 kΩ	½ W	Carbon film
R44	Brown Black Yellow, Gold	5%	100 kΩ	½ W	Carbon film
R45	Orange White Brown, Gold	5%	390	¼ W	Carbon film
R46	Yellow Violet Gold, Gold	5%	4.7	¼ W	Carbon film
R47	Brown Black Red, Gold	5%	1K	¼ W	Carbon film
R48	Orange White Black, Gold	2%	39	1 W	Metal oxide
R49	Brown Green Gold, Gold	5%	1.5	¼ W	Carbon film
R50	Red Red Red, Brown	1%	2.2 kΩ	¼ W	Carbon film
R51	Red Red Brown, Gold	5%	220	¼ W	Carbon film
R52	N/A—no color code	10%	1 kΩ	5 W	Wirewound
R53	Brown Red Gold, Gold	5%	1.2	¼ W	Carbon film
R54	Brown Green Black, Gold	5%	15	¼ W	Carbon film
R55	Red Black Orange, Gold	5%	20 kΩ	½ W	Carbon film
R56	N/A—no color code		2 MΩ		Pot
R57	N/A—no color code		2 MΩ		Pot
R58	N/A—no color code		500 kΩ		Pot
R59	N/A—no color code		500		Pot
R60	N/A—no color code		1 MΩ		Pot

SEMICONDUCTORS

Ref.	Generic	Philips	Radio Shack	Description
CR1	GI 854	ECG 580	No listing	R-Si,600 V,3 A
ok	MR 824	No listing	No listing	R-Si,150 ns,400 V,5 A
CR2	1N 4150	ECG 519	276-1122	D-Si,4 ns,100 V
CR3	1N 4150	ECG 519	276-1122	D-Si,4 ns,100 V
CR4	1N 4150	ECG 519	276-1122	D-Si,4 ns,100 V
CR5	GI 854	ECG 580	No listing	R-Si,600 V,3 A
ok	MR 824	No listing	No listing	R-Si,150 ns,400 V,5 A
CR6	1N 4150	ECG 519	276-1122	D-Si,4 ns,100 V
CR7	1N 4150	ECG 519	276-1122	D-Si,4 ns,100 V
CR8	1N 4001	ECG 116	276-1101	R-Si,600 V,1 A
CR9	IN 4007	ECG 125	276-1114	R-Si,1000 V,2.5 A
CR10	1N 4937	ECG 552	276-1104	R-Si,600 V,1 A
CR11	RGPO1-12	No listing	No listing	
CR12	1N 4150	ECG 519	276-1122	D-Si,4 ns,100 V

SEMICONDUCTORS (cont.)

Ref.	Generic	Philips	Radio Shack	Description
CR13	1N 4150	ECG 519	276-1122	D-Si,4 ns,100 V
CR14	1N 4150	ECG 519	276-1122	D-Si,4 ns,100 V
CR15	1N 5234B	ECG 5013A	276-561	ZD,6.2 V,½ W
CR16	1N 4001	ECG 116	276-1101	R-Si,600 V,1 A
CR17	1N 5234B	ECG 5013A	276-561	ZD,6.2 V,½ W
CR18	1N 5234B	ECG 5013A	276-561	ZD,6.2 V,½ W
CR19	1N 4001	ECG 116	276-1101	R-Si,600 V,1 A
CR20	31DQ	ECG 586	No listing	R-SchtkyBarrier,40 V,6 A
or	MBR 1035	No listing	No listing	R-SchtkyBarrier,35 V,10 A
ok	MBR 1045	No listing	No listing	R-SchtkyBarrier,45 V,10 A
CR21	31DQ	ECG 586	No listing	R-SchtkyBarrier,40 V,6 A
ok	MBR 1045	No listing	No listing	R-SchtkyBarrier,45 V,10 A
CR22	1N 4007	ECG 125	276-1114	R-Si,1000 V,2.5 A
CR23	1N 4007	ECG 125	276-1114	R-Si,1000 V,2.5 A
CR24	1N 4007	ECG 125	276-1114	R-Si,1000 V,2.5 A
CR25	1N 4007	ECG 125	276-1114	R-Si,1000 V,2.5 A
CR26	1N 4934	ECG 552	276-1104	R-Si,600 V,1 A
CR27	1N 4001	ECG 116	276-1101	R-Si,600 V,1 A
CR28	1N 4937	ECG 552	276-1104	R-Si,600 V,1 A
CR29	1N 4937	ECG 552	276-1104	R-Si,600 V,1 A
CR30	1N 4001	ECG 116	276-1101	R-Si,600 V,1 A
CR31	1N 4007	ECG 125	276-1114	R-Si,1000 V,2.5 A
Q1	NSD U01	ECG 188	No listing	T-NPN,2 A,10 W,TO-202N
Q2	BU 406	ECG 379*	No listing	T-NPN,7 A,60 W,TO-220
Q3	2N 4401	ECG 123AP	276-2058	T-NPN,.6 A,.5 W,TO-92
Q4	NSD U51	ECG 189	No listing	T-PNP,2 A,10 W,TO-202N
Q5	2N 5485	ECG 451	276-2062	JFET-N,Si,TO-92
Q6	2N 4401	ECG 123AP	276-2058	T-NPN,.6 A,.5 W,TO-92
Q7	2N 3904	ECG 123AP	276-2009	T-NPN,.6 A,.5 W,TO-92
Q8	2N 6394	ECG 5550	No listing	SCR,50 V,25 A,TO-220
or	S1010BH	ECG 5463	No listing	SCR,200 VRM,10 A,TO-220
Q9	2N 3906	ECG 159	276-1604	T-PNP,1 A,.6 W,TO-92
Q10	2SC 3152	ECG 2309	No listing	T-NPN,6 A,100 W,TO-3PJ
Q11	2N 3906	ECG 159	276-1604	T-PNP,1 A,.6 W,TO-92
Q12	CR 400Y	ECG 5589	No listing	SCR,1200 V,550 A
U1	LM 324N	ECG 987	276-1711	IC,14-p,LP quad op amp
U2	SN74LS38N	ECG 74LS38	No listing	IC,14-p,quad 2-input NAND
U3	4N35	ECG 3041	No listing	IC,6-p,optoisolator,2500 V

*ECG 379 is not recommended in this application—causes severe horizontal foldover at the left side of the screen. Use original equipment BU 406 (if available) or substitute RCA SK 9085, instead.

MISCELLANEOUS

Ref.	OEM	Part #	Description
B1	Eveready	523	4.5 V battery
ok	Mallory	PX21	4.5 V battery
ok	Ray-O-Vac	RPX21	4.5 V battery
CRT	Clinton Taiwan Corp.	—8GHZYB	9-inch white CRT
or	Samsung	Type 10ATY4N	9-inch antiglare CRT
ok	Orion	R51361331-SDH	Green antiglare CRT
F1	Unspecified	Unspecified	2.5 A fuse for 120 V
or	Unspecified	Unspecified	1.6 A fuse for 240 V
NE1	Unspecified	Unspecified	Neon lamp
ok	Radio Shack	272-1102	NE-2H neon lamp
NE2	Unspecified	Unspecified	Neon lamp
ok	Radio Shack	272-1102	NE-2H neon lamp
T1	Taiwan Totoku Electric Co.	157-0026-B	Flyback (128/512)
or	ZFAT	AC-058	Flyback (128/512)
or	Tai-Ho/Taiwan R.O.C.	TH-1565	Flyback (512/Plus)
or	Monitron/Taiwan R.O.C.	157-0026-B	Flyback (Plus)
ok	Tai-Ho/Taiwan R.O.C.	TH-1565C	Bleeder-type flyback
ok	Monitron/Taiwan R.O.C.	157-0026-C	Bleeder-type flyback
ok	Lifon/Taiwan R.O.C.	157-0042-B	Bleeder-type flyback
T3	Coilcraft	157-0047-A	Power transformer

APPENDIX

E

Parts List—Macintosh SE Analog Board

CAPACITORS

Ref.	Cap.	WV	WTemp.	Type	OEM
C1	.1 mfd	35 V		Encapsulated ceramic	Unspecified
C2	100 mfd	25 V	85 °C	Electro AL radial	Nichicon
C3	.1 mfd	100 V		Molded minibox	Unspecified
C4	.1 mfd	100 V		Molded minibox	Unspecified
C5	.033 mfd			Encapsulated ceramic	Unspecified
C6	.001 mfd			Encapsulated ceramic	Unspecified
C7	100 mfd	25 V	85 °C	Electro AL radial	Nichicon
C8	.1 mfd	100 V		Molded minibox	Unspecified
C9	1000 mfd	16 V	85 °C	Electro AL radial	Nichicon
C10	.01 mfd	400 V		Molded minibox	Unspecified
C11	33 mfd	16 V	85 °C	Electro AL axial	Nichicon
C12	.033 mfd	400 V		Ceramic	Unspecified
C13	220 mfd	16 V	105 °C	Electro AL radial	Nichicon
C14	4700 mfd	16 V	85 °C	Electro AL radial	Nichicon
C15	3.9 mfd	35 V	85 °C	HF NP AL radial	Nippon Chemi-con
ok	3.9 mfd	100 V	85 °C	HF NP AL radial	Nichicon
ok	3.9 mfd	100 V	85 °C	Metallized polyester	Panasonic
ok	3.9 mfd	125 V	85 °C	Metallized polyester	Nichicon
ok	3.9 mfd	125 V	85 °C	HF Met polypropylene	Nichicon
C16	.01 mfd	1 kV		Ceramic disk	Unspecified
C17	.01 mfd	1 kV		Ceramic disk	Unspecified

CAPACITORS (cont.)

Ref.	Cap.	WV	WTemp.	Type	OEM
C18	22 mfd	50 V	85 °C	Electro AL axial	Nichicon
C19	10 mfd	160 V	85 °C	Electro AL radial	Nippon Chemi-con
C20	.1 mfd			Encapsulated ceramic	Unspecified
C21	.1 mfd			Encapsulated ceramic	Unspecified
C22	100 mfd	25 V	85 °C	Electro AL radial	Nichicon
C23	.1 mfd			Encapsulated ceramic	Unspecified
C24	220 mfd	16 V	105 °C	Electro AL radial	Nichicon
C25	100 mfd	25 V	85 °C	Electro AL radial	Nichicon
C26	47 pf			Ceramic disk	Unspecified
C27	.01 mfd	1 kV		Ceramic disk	Unspecified

RESISTORS

Ref.	Color Code	Tol.	Ohms	Size	Type
R1	Yellow Violet Brown	5%	470	¼ W	Carbon film
R2	Red Black Red, Gold	5%	2 kΩ	¼ W	Carbon film
R3	Brown Green Yellow, Gold	5%	150 kΩ	¼ W	Carbon film
R4	N/A—no color code		100 kΩ		Height pot
R5	Yellow Violet Yellow, Gold	5%	470 kΩ	¼ W	Carbon film
R6	Blue Grey Orange, Gold	5%	68 kΩ	¼ W	Carbon film
R7	Blue Grey Orange, Gold	5%	68 kΩ	¼ W	Carbon film
R8	Blue Grey Orange, Gold	5%	68 kΩ	¼ W	Carbon film
R9	Orange White Red, Gold	5%	3.9 kΩ	¼ W	Carbon film
R10	Green Blue Red, Gold	5%	5.6 kΩ	¼ W	Carbon film
R11	Yellow Violet Red, Gold	5%	4.7 kΩ	¼ W	Carbon film
R12	Yellow Violet Gold, Gold	5%	4.7	½ W	Carbon film
R13	Brown Black Gold, Gold	5%	1	½ W	Carbon film
R14	Yellow Violet Brown, Gold	5%	470	¼ W	Carbon film
R15	Brown Black Brown, Gold	5%	100	¼ W	Carbon film
R16	Brown Black Brown, Gold	5%	100	¼ W	Carbon film
R17	N/A—no color code	10%	39	5 W	Wirewound
R18	Brown Black Brown, Gold	5%	100	¼ W	Carbon film
R19	Red Red Brown, Gold	5%	220	¼ W	Carbon film
R20	Brown Black Yellow, Gold	5%	100 kΩ	½ W	Carbon film
R21	Brown Black Green, Gold	5%	1 MΩ	½ W	Carbon film
R22	Yellow Violet Yellow, Gold	5%	470 kΩ	½ W	Carbon film
R23	N/A—no color code		1 MΩ		Bright pot
R24	N/A—no color code		2 MΩ		Cut-off pot
R25	Yellow Violet Yellow, Gold	5%	470 kΩ	¼ W	Carbon film

RESISTORS (cont.)

Ref.	Color Code	Tol.	Ohms	Size	Type
R26	Brown Black Green, Gold	5%	1 M Ω	½ W	Carbon film
R27	N/A—no color code		2 M Ω		Focus pot
R28	Yellow Violet Gold, Gold	5%	4.7	½ W	Carbon film
R29	Brown Red Black, Gold	5%	12	1 W	Metal oxide
R30	Red Red Black, Gold	5%	22	¼ W	Carbon film

SEMICONDUCTORS

Ref.	OEM	Philips	Radio Shack	Description
CR1	1N 4001	ECG 116	276-1101	R-Si,600 V,1 A
CR2	GI 854	ECG 580	No listing	R-Si,600 V,3 A
or	MR 824	No listing	No listing	R-Si,150 ns,400 V,5 A
CR3	GI 854	ECG 580	No listing	R-Si,600 V,3 A
or	MR 8248	No listing	No listing	R-Si,150 ns,400 V,5 A
CR4	RGPO1-12	No listing	No listing	
CR5	1N 4937	ECG 552	276-1104	R-Si,600 V,1 A
CR6	1N 4937	ECG 552	276-1104	R-Si,600 V,1 A
CR7	RGPO1-12	No listing	No listing	
Q1	2N 4401	ECG 123AP	276-2058	T-NPN,.6 A,.5 W,TO-92
Q2	BU 406	ECG 379*	No listing	T-NPN,7 A,60 W,TO-220
Q?	7905C	ECG 961	No listing	-5.0 volt reg,1 A,TO-220
U1	SN74LS38N	ECG 74LS38	No listing	IC,14-p,quad 2-input NAND
U2	TDA1170N	ECG 1289	No listing	IC,12-p,TV V-deflection

*ECG 379 is not recommended in this application—causes severe horizontal foldover at the left side of the screen. Use original equipment BU 406 whenever possible. If OEM BU 406 is unavailable, substitute RCA SK 9085, instead.

MISCELLANEOUS

Ref.	OEM	Part #	Description
CRT	Samsung	Type 10ATY4N	White antiglare CRT
ok	Orion	R51361331-SDH	Green antiglare CRT
ok	Clinton Taiwan Corp.	—8GHZYB	9-inch white CRT
B1	Varta	6126	3 V lithium axial Solder-in battery (on logic board)
Fan	Sanyo/Japan	109P0612M402	1-inch thick by 2 ³ / ₈ -inch square 12 V, 0.07 A boxer
ok	Nidec	C 32950-16A	1-inch thick by 2 ³ / ₈ -inch square 12 V, 0.15 A boxer
T2	Tai-Ho/Taiwan R.O.C.	TH-1565C	Bleeder-type flyback
ok	Monitron/Taiwan R.O.C.	157-0026-C	Bleeder-type flyback
ok	Lifon/Taiwan R.O.C.	157-0042-B	Bleeder-type flyback

APPENDIX

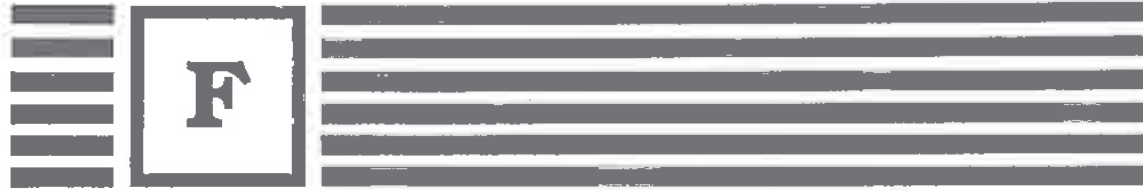

Parts List—Macintosh SE CRT Socket Board

CAPACITORS

Ref.	Cap.	WV	WTemp.	Type	OEM
C1	.1 mfd			Mica	Unspecified
C2	.01 mfd	1 kV		Ceramic disk	Unspecified
C3	.01 mfd	1 kV		Ceramic disk	Unspecified
C4	.01 mfd	1 kV		Ceramic disk	Unspecified
C5	.1	50 V		Encapsulated ceramic	Unspecified

INDUCTORS

Ref.	Color Code	Tol.	Henrys	Size	Type
L1	Red Violet Black, Silver	10%	27 uh	½ W	Epoxy coat
L2	Red Violet Black, Silver	10%	27 uh	½ W	Epoxy coat

RESISTORS

Ref.	Color Code	Tol.	Ohms	Size	Type
R1	Brown Black Red, Gold	5%	1 k Ω	2 W	Metal oxide
R2	Red Red Brown, Gold	5%	220	1/4 W	Carbon film
R3	Red Red Brown, Gold	5%	220	1/4 W	Carbon film
R4	Brown Black Yellow Silver		100 k Ω	1 W	Carbon
R5	Brown Black Yellow Silver		100 k Ω	1 W	Carbon
R6	Brown Black Yellow Silver		100 k Ω	1 W	Carbon
R7	Brown Black Orange, Gold	5%	10 k Ω	1/4 W	Carbon film

SEMICONDUCTORS

Ref.	OEM	Philips	Radio Shack	Description
CR1	1N 4150	ECG 519	276-1122	D-Si,4 ns,100 V
CR2	1N 4150	ECG 519	276-1122	D-Si,4 ns,100 V
CR3	1N 4150	ECG 519	276-1122	D-Si,4 ns,100 V
CR4	1N 4150	ECG 519	276-1122	D-Si,4 ns,100 V
Q1	2N 3904	ECG 123AP	276-2009	T-NPN,.6 A,.5 W,TO-92

Index

- About the Finder option, 21-22
- AC boxer fans, 142-144
- analog boards, 41-54
 - desoldering techniques, 65-69
 - flapping noise, 121-122
 - identifying, 56-59
 - International version, 56-59
 - parts list, 335-340
 - Macintosh SE, 293-296, 341-344
 - maximum upgrades, 128-131
 - minimum upgrades, 126-128
 - removal/installation, 131-135
 - removing/installing wiring harness, 69-72
 - tune-up procedure, 41-54
 - US version, 56
 - parts list, 327-334
 - vinyl jacket removing/installing, 59-62
- analog multimeters, 14
- antiglare magnification screens, 161-163
- aspect ratio, monitors, 36
- audio circuit, schematic, 146
- audio problems
 - adding external speakers, 156-157
 - adding speaker grill, 155-156
 - distorted sound, 150
 - no sound, 147-150
 - scratchy sound, 150
 - weak sound, 150
- audio tests, 151-154
- audio upgrades, 145-158
 - Macintosh SE, 296
- axial caps, 91-92
- Balance Test option, 54
- bench, work area, 17
- board references, 63
- boards
 - analog, 41-54
 - logic, 41, 297-298
- brightness control
 - adjusting, 49
 - Macintosh SE, 288
 - problems, 78-80
- cables, custom keyboard, 219-222
- Cathode Ray Tube (CRT), 42-44
 - upgrades, 163-168
- center circles, 30
- Center Cross option, 51
- centering test, 29
- chassis, 45-46
- checklist, preliminary, 19-20
- chips, replacing ROM, 187-190
- circularity, checking, 30-31
- color codes, resistor, 115-117
- component level test set-up, 64-65
- continuity tests, checking
 - resistor values, 114-117
- controls
 - brightness, 49, 78-80
 - focus, 53-54, 72-78

- CRT pins, cleaning, 76-77
- cut-off, adjusting TPG, 47-49

- DC boxer fans, 139-142
- dead sets
 - checking resistor values, 114-117
 - compound problems, 113-114
 - flapping noise, 117-123
 - troubleshooting, 109-124
 - visual inspection, 111-113
- dealer addresses, 323-326
- default values, restoring, 36
- desoldering analog boards, 65-69
- diagnostic software, 15
- dialog boxes
 - Set Startup, 37-38
 - Unlisted Mac Monitors, 25
- digital multimeters, 14
- discharge tool, custom made, 11-13
- disk drive/ROM upgrades, 186-195
- disk drives
 - accidental disk
 - initialization, 194-195
 - data cable pin assignments, 194
 - mixing 800K and 400K, 193-195
 - removal, 186-187
 - upgrades, 195-196
- disks, System, 16-17
- display enlargements, 159-161
 - advantages, 160
- display problems
 - burning smell/smokes, 102-103
 - C1 failure, 87-93
 - collapses
 - to a horizontal line, 105-106
 - to a pinprick, 107
 - to a vertical line, 83-93
 - display problems—cont
 - cracked solder joints, 84-87
 - distortion, 99-102
 - flyback transformer, 93-99
 - no raster, 103-105
 - displays, 42
 - adjusting external monitors, 172-173
 - centering TPG, 51-53
 - CRT removal/installation, 164-168
 - glare test, 163
 - Macintosh SE, 288-293
 - maintaining linearity, 160
 - TTL video adapter, 168-171
 - drive capacity, determining, 21
- electrolytic capacitors,
 - measuring leakage, 79-80
- equipment
 - checking voltage, 38-39
 - soldering, 15
 - test, 13-15
- expansion cards, Macintosh SE, 305-306
- external monitors
 - adjusting, 172-173
 - Lisa, 274
 - Macintosh XL, 274
 - unlisted, 25
- failure avoidance strategy, 125-126
- fans
 - AC boxer, 142-144
 - DC boxer, 139-142
 - Panaflo boxer, 140
 - piezoelectric, 135-139
 - upgrading, 135-144
- Finder, 16-17
- flyback transformer (T1), 93-99
 - identifying, 93-98
 - replacing, 98-99
- focus, checking, 33-34
- focus control
 - adjusting TPG, 53-54
 - Macintosh SE, 288
 - problems, 72-78
 - burned resistors, 73-75
 - CRT socket cable, 75-76
- Focusing Text option, 33-34, 53-54
- Fresnel magnification lens, 161-163
- friction tape, 2
- full-screen circularity test, 31

- ghosts, screen, checking for, 34-35
- glossary, 313-322
- grounding spider, 7

- hand tools, computer repair, 2-5
- hard drives
 - Lisa, 262-266
 - Macintosh SE, 307-311
 - Macintosh XL, 262-266
 - noisy, 271
- height, adjusting TPG, 50
- height and width, checking, 26-27
- horizontal deflection capacitor (C1) testing/replacing, 87-93
- horizontal scan rate, 84-85
- horizontal sweep, 83
- hot borders, 31

- Input/Output (I/O) board tests
 - Lisa, 251-252
 - Macintosh XL, 251-252
- internal monitors
 - Lisa, 274-280
 - Macintosh XL, 274-280
- International version analog board, 56-59
- parts list, 335-340

keyboard repairs, 207-222

keyboards

broken key switches, 210-217

checking connector cable, 217-219

custom cables, 219-222

dead, 217-222

disassembly, 208

effects of static electricity, 219

intermittent key switches, 209-210

Macintosh SE, 302-303

safety precautions, 207-208

linearity, checking, 28

Lisa

800K disk drive upgrade, 268-269

automatic startup tests, 247-254

booting operating system, 253-254

built-in service mode, 254-262

disassembly procedure, 237-247

disk drive problems, 256-262

expansion card upgrades, 272-273

hard drive

repairs, 262-266

upgrades, 270

I/O board tests, 251-252

identifying models, 235-237

MacWorks Plus, 266-268

memory

sizing, 249

test, 250

Lisa—cont

upgrades, 273

MMU Register test, 249

mouse, 223-234

repairs, 235-280

ROM

Checksum test, 247-248

identification, 252-253

Versatile Interface Adapter (VIS) test, 250

video upgrades, 274-280

logic boards, 41

board level 128K to 512K upgrades, 176

component level 128K to 512K RAM upgrades, 177-178

flapping noise, 117-121

Macintosh SE, 297-298

troubleshooting component level upgrades, 185-186

Model 820-0086-C, 178-184

Model 820-0141-A, 184-185

Macintosh

mouse, 223-234

SE

adjustments, 285-287

analog board parts list, 341-344

analog boards, 293-296

CRT socket board parts list, 345-346

dead sets, 293

expansion card upgrades, 305-306

internal hard drive

upgrades, 307-311

keyboard repairs, 302-303

logic boards, 297-298

Macintosh—cont

memory upgrades, 298

mouse, 303-305

power supply problems, 287-288

preliminary checks, 284-285

repairs, 281-312

SCSI ID, 309-311

SIMM upgrades, 299-302

tools and techniques, 281-283

TPG tune-up procedures, 285-287

video upgrades, 297

XL

800K disk drive upgrade, 268-269

automatic startup tests, 247-254

booting operating system, 253-254

built-in service mode, 254-262

disassembly procedure, 237-247

disk drive problems, 256-262

expansion card upgrades, 272-273

hard drive repairs, 262-266

hard drive upgrades, 270

I/O board tests, 251-252

identifying models, 235-237

MacWorks Plus, 266-268

memory sizing, 249

memory test, 250

memory upgrades, 273

MMU Register test, 249

repairs, 235-280

ROM Checksum test, 247-248

- Macintosh—cont
 - ROM identification, 252-253
 - Screen Kit installation, 274-280
 - Versatile Interface Adapter (VIS), 250
 - video upgrades, 274-280
- MacWorks Plus, 266-268
- magnetism, effects on speakers, 157
- manufacturers addresses, 323-326
- memory sizing
 - Lisa, 249
 - Macintosh XL, 249
- memory test
 - Lisa, 250
 - Macintosh XL, 250
- memory upgrades, Macintosh SE, 298
- menus
 - Screen Sizes, 24-25
 - Test Patterns, 51, 53-54
- metal poly caps, 92-93
- metric system, 27-28
- MMU Register test
 - Lisa, 249
 - Macintosh XL, 249
- model numbers, 20-21
- monitors, checking, advanced techniques, 36-38
- mouse
 - cleaning, 227-228
 - dead, 232-234
 - disassembly, 225-227
 - intermittent button, 229-231
 - intermittent functions, 231-232
 - Macintosh SE, 303-305
 - reassembly, 228-229
- mouse—cont
 - repairs, 223-234
 - safety precautions, 224
 - switch replacement, 229-231
 - testing cable, 233
 - testing switch, 230-231
 - understanding, 224-225
 - worn feet, 233-234
- multitesters
 - choosing, 13-14
 - required, 13
- Option key, 27-28, 31
- Optional Balance Test, 33
- options
 - About the Finder, 21-22
 - Balance Test, 54
 - Center Cross, 51
 - Focusing Text, 53-54
- Panaflo boxer fan, 140
- pattern, moving, 30-31
- picture tube, discharging, 11
- piezoelectric fans, 135-139
- pixels, 159
- power supply
 - connected to chassis, 9
 - output ratings, 47
 - problems
 - fluctuating voltage, 69-72
 - low voltage, 63-69
 - troubleshooting, 55-80
 - upgrades, 125-144
- precautions, 1-2
- preliminary
 - checklist, 19-20
 - checkup procedures, 19-40
- procedures
 - preliminary check up, 19-40
 - take-apart, 6-13
- programmers switch, 2
- purity tabs, breaking seal, 51-53
- radial caps, 92
- raster, 103-105
- Read Only Memory (ROM), replacing chips, 187-190
- rectifiers, shorted, 118-120
- repairs
 - keyboard, 207-222
 - Lisa, 235-280
 - hard drive, 262-266
 - Macintosh SE, 281-312
 - XL, 235-280
 - hard drive, 262-266
 - mouse, 223-224
- resistors
 - checking, 114-117
 - checking tolerance, 116-117
 - color codes, 115-117
 - focus control, 73-75
 - overheating, 115
- RFI shield, 8
- ROM
 - Checksum test
 - Lisa, 247-248
 - Macintosh XL, 247-248
 - identifying versions, 190-191
 - replacing chips, 187-190
- safety rules, 1-2
- screen
 - balance, checking, 32-33
 - ghosts, checking for, 34-35
 - size, choosing, 24-26
- Screen Sizes menu, 24-25
- screens, 42
 - antiglare magnification, 161-163

- SCSI upgrades, 196-200
- Set Startup dialog box, 37-38
- setting preferences, monitors, 37
- single inline memory module (SIMM), 202-205
- Small Computer Systems Interface (SCSI)
 - upgrades, 196-200
- socket cable, focus control, 75-76
- software
 - diagnostic, 15
 - system, 16-17
- soldering
 - equipment, 15
 - pencils, choosing, 15-16
- sound, technical definition, 151
- speaker grill, adding, 155-156
- speakers
 - adding external, 156-157
 - effects of magnetism, 157
 - testing/replacing, 148-150
- static electricity, effect on
 - keyboards, 219
- Sun Remarketing, MacWorks Plus, 266-268
- sweep circuits, 83
- switches, programmers, 2
- System disks, 16-17
- system software, 16-17

- T-squares, 25-28
- take-apart procedures, 6-13
- test equipment, 13-15
- Test Pattern Generator (TPG), 15
 - starting, 22-24
 - tune-up procedure, 41-54
- Test Patterns menu, 51, 53-54
- Test Tone Oscillator (TTO), 151-154
- tests, centering, 29
- text, focusing, 33-34
- tools
 - discharge, 11-13
 - hand, to repair computer, 2-5
- transistor transistor logic (TTL)
 - video adapter, 168-171
- trimmer pots, adjusting, 46

- Unlisted Mac Monitors dialog box, 25
- upgrades
 - 512Ke to 4Mb, 205-206
 - audio, 145-189
 - board level 512Ke to Mac Plus, 200-201
 - Cathode Ray Tube (CRT), 163-168
 - disk drive/ROM, 186-195
 - disk drives, 195-196
 - Lisa
 - 800K disk drive, 268-269
 - expansion card, 272-273
 - hard drive, 270
 - memory, 273
 - video, 274-280
 - logic board, 175-186
 - Mac Plus SIMM, 202-205
 - Macintosh SE
 - audio, 296
 - expansion cards 305-306
 - internal hard drive, 307-311
 - memory, 298
 - power supply, 293-296
 - SIMM 299-302
 - Macintosh XL
 - 800K disk drive, 268-269
 - expansion card, 272-273
 - hard drive, 270
 - memory, 273
 - video, 274-280
 - maximum analog board, 128-131
 - minimum analog board, 126-128
 - power supply, 125-144
- upgrades—cont
 - SCSI, 196-200
 - video, 159-174
- US version analog board, 56
 - parts list, 327-344

- Versatile Interface Adapter (VIS), 250
- vertical scan rate, 85
- vertical sweep, 83
- video
 - display problems, Macintosh SE, 288-293
 - problems, 81-108
 - reversing, 34-35
 - upgrades, 159-174
 - Macintosh SE video, 297
- vinyl jackets
 - Macintosh SE, 288
 - removing/installing analog board, 59-62
- voice audio tests, 151-154
- volt meters, 13
- voltage
 - adjusting TPG, 45-47
 - checking, 38-39
 - checking adapter, making, 39
 - fluctuating, 69-72
 - low, 63-69

- width, adjusting TPG, 49-50
- width coil slug, adjusting, 49-50
- wiring harness
 - analog board, 69-72
 - Macintosh SE, 288
 - testing, 71-72
- work area, setting up, 17-18

- zener diode, 63-64